

Surface Mount Schottky Barrier Diodes

(Pb) Lead(Pb)-Free

Feature:

- *Extremely High Switching Speed.
- *Low Forward Voltage and Low Reverse Current.
- *High Reliability.
- *Schottky Barrier Diodes Encapsulated in a SOD-523 Package

Description:

These schottky barrier diodes are designed for high speed switching applications circuit protection, and voltage clamping, Extremely low forward voltage reduces conduction loss, Miniature surface mount package is excellent for hand held and portable applications where space is limited.

**SMALL SIGNAL
SCHOTTKY DIODES
200m AMPERES
30 VOLTS**

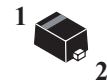

SOD-523

SOD-523 Outline Dimensions

Unit:mm

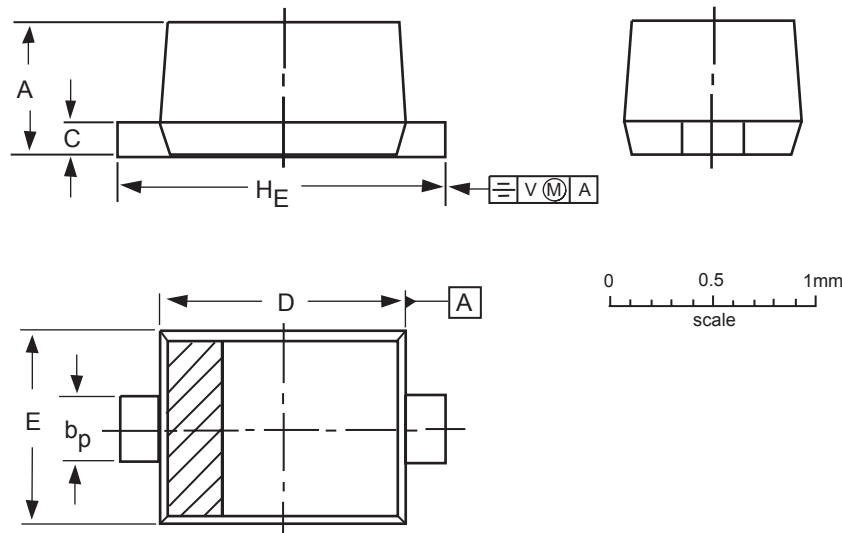

DIMENSIONS (mm are the original dimensions)

UNIT		A	b _p	c	D	E	H _E	V
mm	max	0.7	0.35	0.2	1.3	0.9	1.7	0.15
	min	0.5	0.25	0.1	1.1	0.7	1.5	

Note1. The marking bar indicates the cathode.

OUTLINE VERSION	REFERENCES			EUROPEAN PROJECTION	ISSUE DATE
	IEC	JEDEC	EIAJ		
SOD-523			SC-79		98-11-25

Maximum Ratings (T_A=25°C Unless otherwise noted)

Characteristic	Symbol	Value	Unit
Reverse Voltage	V _R	30	V
Average Rectifier Forward Current	I _{F(AV)}	200	mA
Peak Forward Surge Current ⁽¹⁾	I _{FSM}	1.0	A
Operating Junction Temperature Range	T _J	125	°C
Storage Temperature Range	T _{stg}	-40 to +125	°C

Electrical Characteristics (T_A=25°C Unless otherwise noted)

Characteristic	Symbol	Min	Max	Unit
Reverse Breakdown Voltage I _R = 100μA	V _{(BR)R}	30	-	V
Forward Voltage I _F = 200mA	V _F	-	0.60 0.50	V
Reverse Leakage V _R = 10V	I _R	-	1.0 30	μA

NOTE: 1. 60HZ for 1 ϕ

Device Marking

Item	Marking	Equivalent Circuitdiagram
WSD520S	B	
WSD521S	C	

Electrical characteristic curves(Ta=25°C)

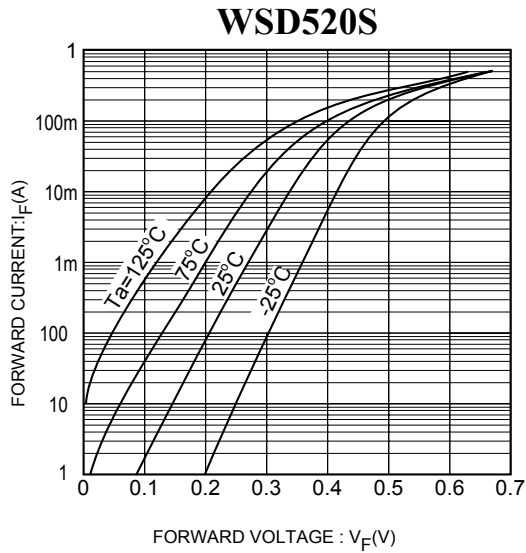

Fig. 1 Forward characteristics

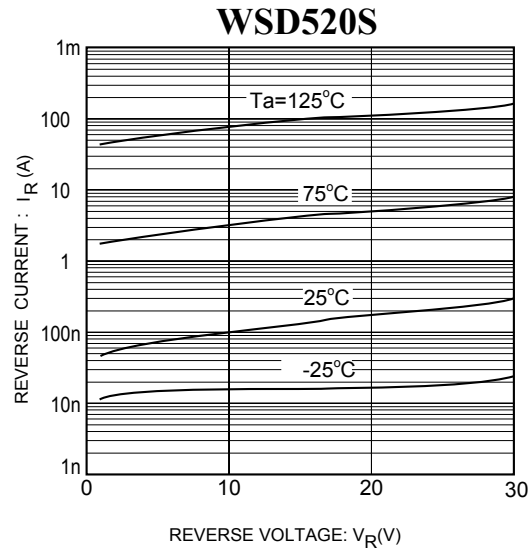

Fig. 2 Reverse characteristics

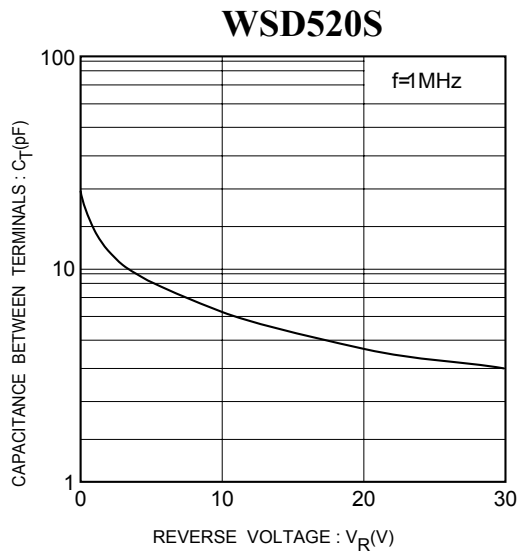

Fig. 3 Capacitance between terminals characteristics

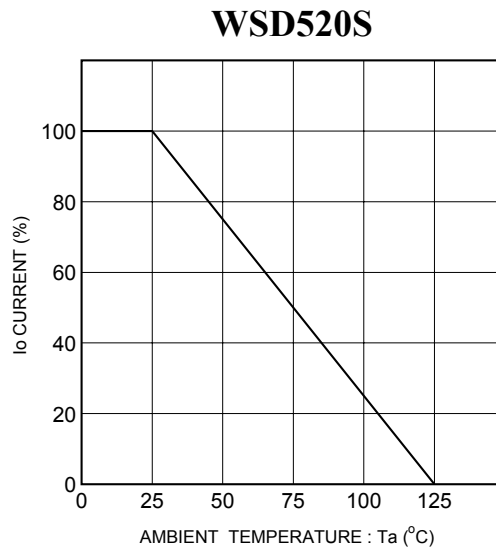

Fig 4. Derating curve
(mounting on glass epoxy PCBs)

Electrical characteristic curves(Ta=25°C)

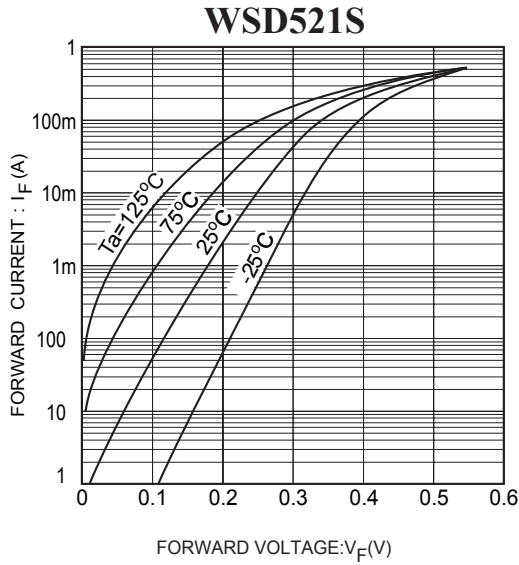

Fig. 1 Forward characteristics

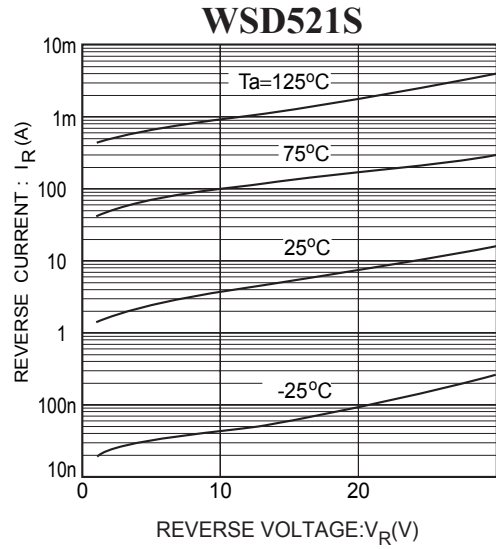

Fig. 2 Reverse characteristics

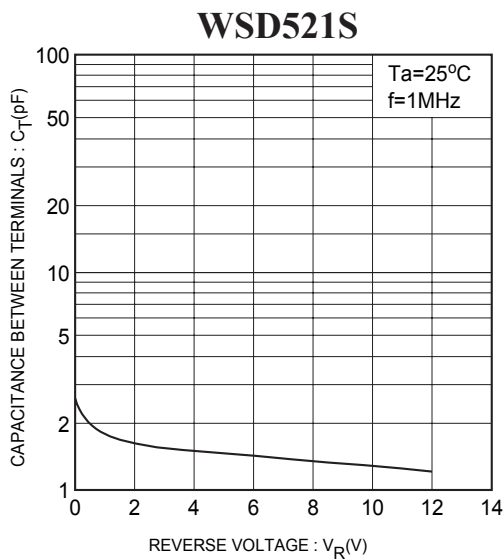

Fig. 3 Capacitance between terminals characteristics

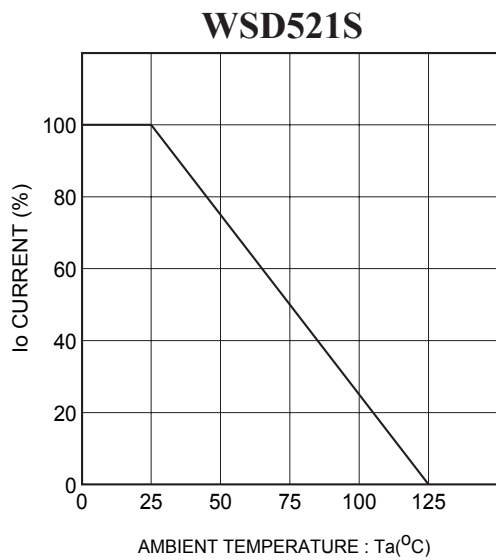

Fig. 4 Derating curve
(mounting on glass epoxy PCBs)