

VISION VV5409 Digital CMOS Sensor

CIF Format Monochrome Digital Image Sensor



CUSTOMER DATASHEET (RESTRICTED)

CHARACTERISTICS

- 525 line, 60 fps / 625 line, 50 fps output formats
- CCIR-601/656 compliant timing
- CIF Format Pixel-Array:
355 x 292 (306 x 244 for 525 line mode)
- Variable frame rate:
60/30/15/7.5 fps & 50/25/12.5/6.25 fps
- Crystals Supported:
13.5 MHz, 14.31818 MHz, and 35.46895 MHz
- On-chip 8-bit A/D convertor
- 1 / 2 / 4 - wire proprietary digital video bus
- 2-wire serial control interface
- Programmable exposure and gain values
- Automatic black level calibration
- Programmable inter line/frame timings
- Low power
- Standard 48 BGA and 48LCC Packages
- On-chip Audio pre-amp.

GENERAL DESCRIPTION

VV5409 is a highly-integrated CMOS camera with output in 3 digital video formats:

1. 525 line, 60 fps - 306 x 244 image size -13.5 MHz or 14.31818 MHz crystals.
2. 625 line, 50 fps - 356 x 292 image size -13.5 MHz or 17.734475 MHz crystal.
3. "VV6404 mode" - 356 x 292 image size .

VV5409 contains a two stage flash 8-bit analogue-to-digital converter. Device set-up is fully automatic through the CMOS sensor's built in automatic black level calibration algorithm.

The main features of the sensor's digital interface are as follows:

1. Tri-stateable 1 / 2 / 4 - wire output video-data-bus for 8-bit video-data. Frame and line format information is encoded within the video output data stream.
2. A 2-wire serial-interface for controlling the operation of the sensor.
3. Data qualification clock, QCK (Tri-stateable)
4. Frame synchronisation signal, FST (Tri-stateable)

Exposure and gain values are programmed through the bi-directional 2-wire serial-interface.

TECHNICAL SPECIFICATION

Pixel Resolution	306 x 244 or 356 x 292
Pixel Size	9.0 µm x 8.25 µm
Exposure control	25000:1 (performed by host)
Format	CIF
SNR	TBD

Supply Voltage	5.0 V DC +/- 5%
Supply Current	TBD
Operating Temperature Range	0°C - 40°C
Technology	0.6µm 2-Level Metal CMOS
Package type	48BGA and 48LCC

Important:

A host processor is required to perform Automatic Exposure and Gain control (AEC/AGC) via the sensor serial interface, and to generate an appropriate video output timing format.

Commercial In Confidence



Table of Contents

1. Introduction	4
1.1 Typical applications	4
1.2 VV5409 overview	4
1.3 Automatic Black Level Calibration.....	4
1.4 Exposure Control.....	5
1.5 Digital Interface	5
1.6 System Reset.....	6
1.7 Startup configuration of Setup Data	6
1.8 Other Features	6
2. Operating Modes	8
2.1 Video Timing	8
2.2 Pixel-Array.....	9
3. Automatic Black Level Calibration	11
4. Exposure Control	12
5. Digital Video Interface Format	14
5.1 General description	14
5.2 Embedded control data	15
5.3 Video timing reference and status/configuration data	17
5.4 Detection of sensor using data bus state	33
5.5 Resetting the Sensor Via the Serial Interface	33
5.6 Power-up, Low-power and Sleep modes	33
5.7 Qualification of Output Data	38
6. Serial Control Bus	43
6.1 General Description.....	43
6.2 Serial Communication Protocol	43
6.3 Data Format	43
6.4 Message Interpretation.....	45
6.5 The Programmers Model.....	45
6.6 Register descriptions	47
6.7 Types of serial interface messages.....	58
6.8 Serial-Interface Timing	62
7. Clock Signal	64
8. Synchronising Multiple Cameras	65
9. Other Features	67
9.1 Microphone Amplifier.....	67
9.2 Debounced Switch Input	68
9.3 Serial-Interface Programmable Pins	68
10. Detailed specifications	69
11. Pinouts and pin descriptions	70
11.1 Sensor pin list.....	70
11.2 48BGA pinout.....	72
11.3 48LCC Pinout.....	73
12. Package dimensions	74

Commercial In Confidence



12.1 48BGA (400G)..... 74
 12.2 48LCC 75
 13. Suggested VV5409 support circuit..... 76
 14. Evaluation kits (EVK's)..... 78
 15. Ordering details 78

Note: In this document, where hexadecimal values are used, they are indicated by a subscript H, such as FF_H; other values are decimal.



1. Introduction

The VV5409 is a highly integrated CMOS digital imaging sensor with 3 different digital video output formats. The sensor contains a two-stage flash, 8-bit ADC (Analogue to Digital Converter). Exposure control can be handled automatically by the host. Other device set-ups can be controlled using the 2-wire serial-interface.

1.1 Typical applications

- Monochrome Video Surveillance/CCTV
- Biometrics
- Automotive
- Machine Vision

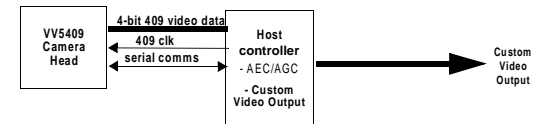

Figure 1.1 : Typical block diagram: Monochrome Video application

1.2 VV5409 overview

VV5409 is a CIF format CMOS image sensor which outputs digital pixel-data at frame and line rates compatible with either NTSC or PAL video standards. Table 1.1 summarises the main video modes.

The pixel-data is digitised by an on-chip 8-bit ADC (Figure 1.2).

All of the video modes can be programmed through the serial-interface. The various operating modes are detailed in Section 2.

Important: The sensor's video-data stream only contains raw pixel-data. An intelligent host co-processor is required to perform auto-exposure and gain control, and to generate appropriate video output timing.

Mode	Clock (MHz)	Pixel Clock Divisor	Image Size	Line Time (µs)	Lines per Frame	Frame Rate (fps)
CIF - 25 fps	7.15909	2	356 x 292	131.580969	304	24.99961
CIF - 30 fps	7.15909	2	356 x 292	109.790490	304	29.96137
PAL (656)	13.500000	2	356 x 292	64.000000	625	25.00000
NTSC (656)	13.500000	2	306 x 244	63.555564	525	29.97003
PAL (8 fsc)	35.46895	5	356 x 292	63.999639	625	25.00014
NTSC (8 fsc)	28.636360	5	306 x 244	63.555564	525	29.97003

Table 1.1 : Video Modes

1.3 Automatic Black Level Calibration

Automatic black level control ensures consistent picture quality across the whole range of operating conditions.

1.4 Exposure Control

VV5409 does not include any form of automatic exposure and gain control. To produce a correctly exposed image in the sensor-array, an exposure control algorithm must be implemented externally. This must be performed by a host controller/co-processor.

1.5 Digital Interface

The sensor offers a very flexible digital interface, its main components are listed below:

1. A tri-stateable, 4-wire, data-bus (D[3:0]) for sending both video-data, and embedded timing references
2. A data qualification clock, QCK, which can be programmed through the serial-interface, to behave in a number of different ways (Tri-stateable)
3. A line start signal, LST (Tri-stateable)
4. A frame start signal, FST (Tri-stateable)
5. OEB tri-states all 8 data-bus lines, D[7:0], the qualification clock, QCK, LST, and FST
6. The ability to synchronise the operation of multiple cameras
7. A 2-wire, serial-interface, (SDA, SCL) for controlling and setting up the device

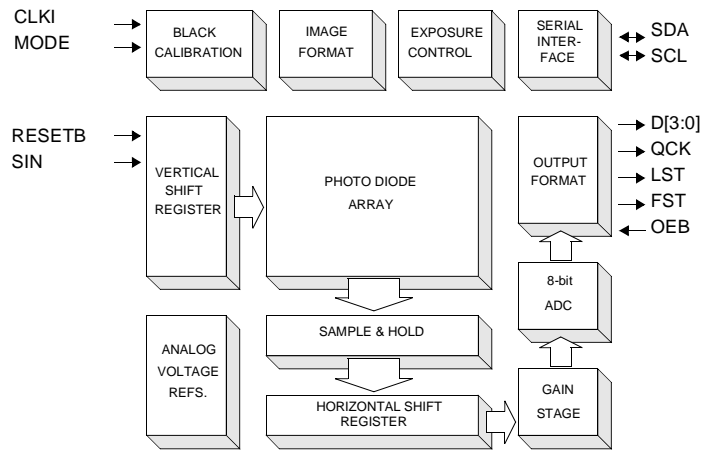

Figure 1.2 : Block Diagram of VV5409 Image Sensor

1.5.1 Digital Data Bus

Along within the pixel-data, codes representing the start and end of fields and the start and end of lines are embedded within the video-data stream to allow a host controller to synchronise with video-data the camera module is generating. Section 5. defines the format for the output video-data stream.

The 8-bit data which makes up the video-data stream can be output on the data-bus in one of 3 ways:

1. A series pair of 4-bit nibbles, most significant nibble first, on 4-wires.
2. Four, 2-bit values, most significant 2-bit value first, on 2-wires.
3. Bit-serial data, eight 1-bit values, least significant bit first, on 1-wire.

For the 2, and 1-wire modes, the complement of the data can also be enabled in addition to the data itself.

1.5.2 Frame Grabber Control Signals

To complement the embedded control sequences, the data qualification clock (QCK), the line-start-signal (LST) and the field-start-signal (FST), signals can independently be set-up to either be:

1. Disabled
2. Free-running
3. Qualify only the control sequences and the pixel-data
4. Qualify the pixel-data only.

There is also the choice of two different QCK frequencies where one is twice the frequency of the other.

1. Fast QCK: the falling edge of the clock qualifies every 4, 2 or 1-bit block of data that makes up a pixel value.
2. Slow QCK: the rising edge qualifies the 1st, 3rd, 5th, etc. blocks of data which make up a pixel value, while the falling edge qualifies the 2nd, 4th, 6th etc. blocks of data. For example, in the 4-wire mode, the rising edge of the clock qualifies the most significant nibbles, while the falling edge of the clock qualifies the least significant nibbles.

1.5.3 Synchronisation of Multiple Cameras

Multiple camera configurations can be synchronised by applying a rising edge to the SIN pins once per frame (every second field).

The FST/DIN pin of the one of cameras (the master) can be re-configured as a SNO output to supply the synchronisation signal for the other cameras.

Note: The SNO function has not been verified.

1.5.4 2-wire Serial-Interface

The 2-wire serial-interface provides complete control over how the sensor is setup and run. The sensor serial address is fixed at 20H.

Two broadcast serial-interface addresses are supported. One allows all sensors to be written to in parallel, and if a VISION co-processor is in use, the other allows all sensors and co-processors to be written to in parallel.

Section 6. defines the serial-interface communications protocol, and the register map of all the locations which can be accessed through the serial-interface.

1.6 System Reset

Using the RESETB pin (active low, internal pull-up), a System Reset of the sensor can be activated. The sensor behaves exactly as if a power down then power up has taken place, i.e., all sensor serial registers are reset to their default status, and video timing will be reset.

1.7 Startup configuration of Setup Data

The sensor should be correctly configured on power up, or following a System Reset (Section 1.6), for correct operation of the sensor, by writing settings to the camera registers on startup. This applies to the Setup0 [16], Setup1 [17], and at1 [121] registers in particular.

1.8 Other Features

1.8.1 Microphone Pre-Amplifier

Pins AIN, and AOUT, are the input, and output respectively, for a 2-stage Microphone amplifier. The gain of this amplifier is programmable through the serial-interface.

The output of the Microphone can be multiplexed at the end of a video line, onto the input of the 8-bit ADC



digitised pixel-data. This value is output, once per line, as part of the embedded “end-of-line” sequence. While this amplifier is primarily intended as a Microphone amplifier, it can be used as way to digitise any “slow-moving” analogue input. The maximum sample rate is approximately 15k samples/second as there is only one sample per line of video. See also Section 9.1.

1.8.2 Debounced Switch Input

This de-bounced input (the FST/DIN pin re-configured as a debounced switch input pin) is designed for use with a switch, for still-image capture. If the switch is pressed, it sets a flag in the status line for the next field, marking it as the one the user has selected. See also Section 9.2.



2. Operating Modes

2.1 Video Timing

The video format mode on power-up is determined by the value of bits 6-7 of the setup0 register. It may be desirable to access a larger image array size by enabling PAL or NTSC video output modes. While the video output timing from the sensor is *compatible* with PAL.NTSC/CCIR656 formats, video sync timing and encoding must be performed by an external host controller.

The frame/field rate is programmable only through the serial-interface. Setup0 bit 3 selects between 30 and 25 frames per second for the CIF modes, and 60/50 fields per second for the Digital, and Analog Timing modes.

Video Mode	setup0[6-7]	setup0 Bit3	Video Mode
CIF (VV6404)	00 ₂	0	CIF - 25 fps
		1	CIF - 30 fps
DIGITAL (CCIR)	01 ₂	0	PAL (656)
		1	NTSC (656)
ANALOG (TV)	10 ₂	0	PAL (8 fsc)
		1	NTSC (8 fsc)

Table 2.1 : Video Timing Mode Select Pins

The number of video lines-in for each frame-rate, is the same (304) for each of the CIF modes. The slower frame rate is implemented, by simply extending the line period from 393 pixel periods, to 471 pixel periods. Table 2.2 details the setup for each of the video timing modes. Changing either the mode pin, or a serial write to the *video_timing* register will force the contents of other registers in the serial-interface to change to the appropriate values. If, for example, a different data output-mode is required from the default, for a particular video mode, a write to the appropriate register after the mode has changed will setup the desired value.

Mode	Video Mode	Clock (MHz)	Pixel Clock Divisor	Video Data	Line Length	Field Length	Data Output Mode
0	CIF - 25 fps	7.15909	2	356 x 292	471	304	4-wire
1	CIF - 30 fps	7.15909	2	356 x 292	393	304	4-wire
2	PAL(656)	13.500000	2	356 x 292	432	312/313	4-wire
3	NTSC (656)	13.500000	2	306 x 244	429	262/263	4-wire
4	PAL (8 fsc)	28.636360	5	356 x 292	454	312/313	4-wire
5	NTSC (8 fsc)	35.46895	5	306 x 244	364	262/263	4-wire

Table 2.2 : Video Timing Modes

For flexibility, the number of pixel clocks per line, and the number of lines per field, can be programmed through the serial-interface, both to a maximum value of 510.

2.2 Pixel-Array

The physical pixel-array is 360 x 292 pixels. The pixel size is 9.0µm by 8.25 µm. The useable image size for NTSC format is 302 x 240 pixels while for PAL and CIF formats it is 352 x 288 pixels. An optional border 2 pixels deep on all 4 sides of the array can be enabled (Figure 2.3). The resulting image sizes are 306 x 244 for NTSC, and 356 x 292 pixels for PAL and CIF video modes. The border option is programmable through the serial-interface.

Video Modes	Border	Output Image size (column x row)
NTSC	Disabled	302 x 240
	Enabled	306 x 244
PAL, CIF	Disabled	352 x 288
	Enabled	356 x 292

Table 2.3 : Image Format Selection

Figure 2.2 shows how the 302 x 240 sub-array is aligned within the bigger 352 x 288 pixel-array. The position of the 306 x 244 sub-array has been offset by one column, relative to central location. Image read-out is non-interlaced raster scan. The larger 352 x 288 array covers pixels 4-355 and 2-289.

With extra border rows/columns enabled, and Figure 2.3 shows the relative array positions.

Note: To enable correct readout of sensor pixels, bit 7 of the Setup1 register [17] must be set to 0. Its default power-up value is 1.

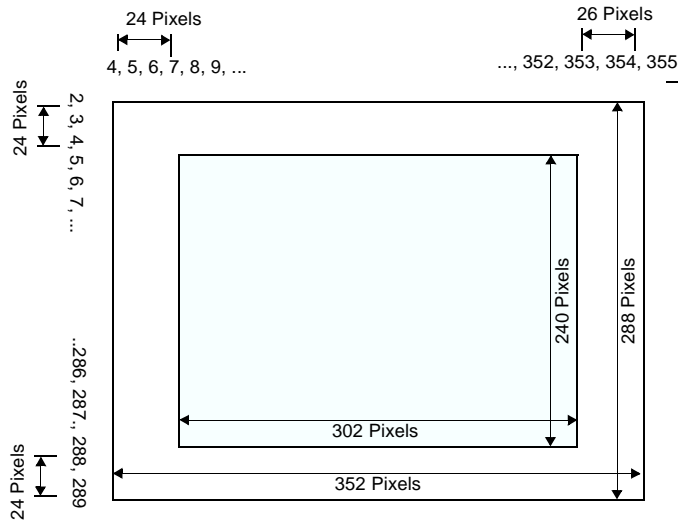

Figure 2.1 : VV5409 Image format with border rows/columns disabled

Commercial In Confidence

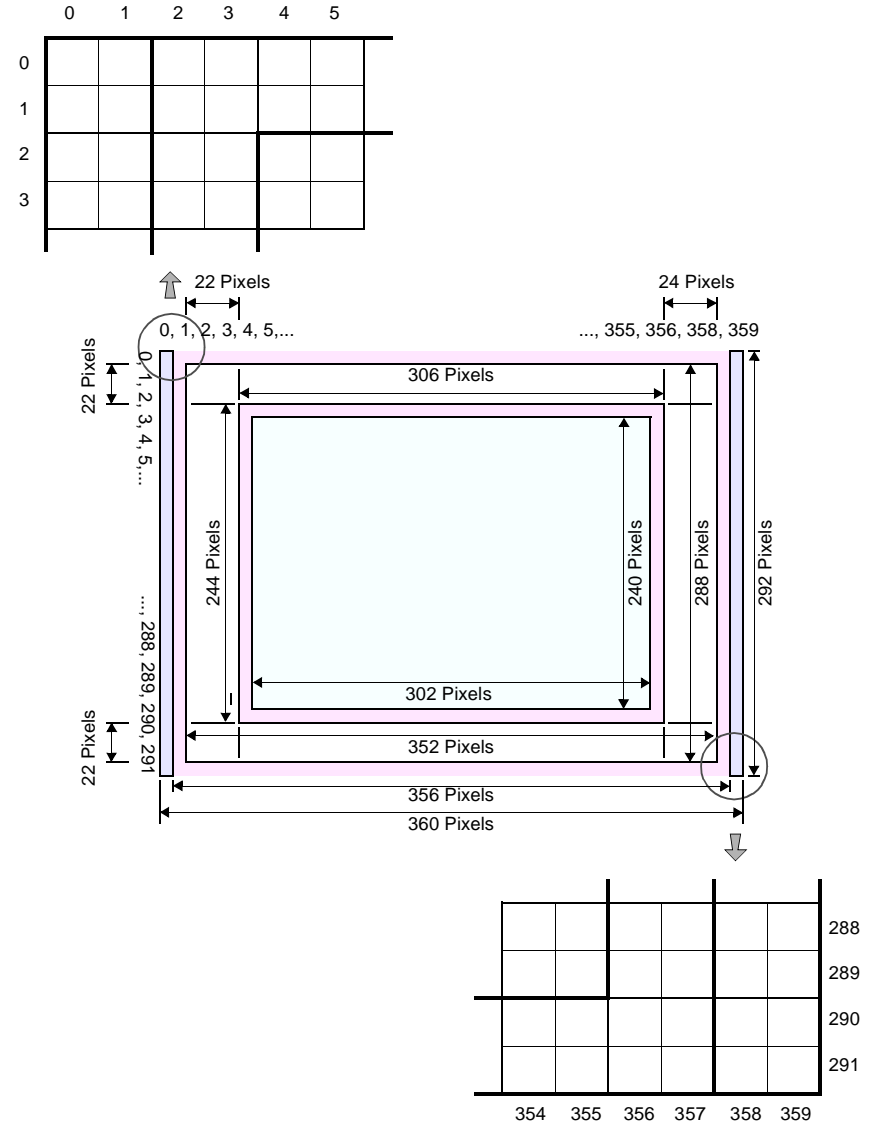

Figure 2.3 : VV5409 Image format with border rows/columns enabled

Commercial In Confidence



3. Automatic Black Level Calibration

Black calibration is used to remove voltage offsets that cause shifts in the black level of the video signal. VV5409 is equipped with an automatic function that continually monitors the output black level and calibrates if it has moved out of range. The signal is corrected using two "Black-Calibration" DACs:

1. ADC stage DAC, B0[7:0].
2. OSA Input Offset Compensation DAC, B1 [7:0]

Black calibration can be split into two stages, **monitor** and **update**. During the monitor phase the current black level of 4 black reference lines at the top of the pixel array is compared against two threshold values. If the current value falls outside the threshold window then an update cycle is triggered. The update cycle can also be triggered by a change in the gain applied to sensor core or via the serial interface (see also Section 6.6.5).



4. Exposure Control

The exposure time for a pixel and the gain of the input amplifier to the 8-bit ADC are programmable via the serial interface. The explanation below assumes that the gain and exposure values are updated together as part of a 5 byte serial interface auto-increment sequence.

The exposure is divided into 2 components - coarse and fine. The coarse exposure value sets the number of lines a pixel exposes for, while the fine exposure sets the number of additional pixel clock cycles a pixel integrates for. The sum of the two gives the overall exposure time for the pixel array.

$$\text{Exposure Time} = \text{Clock Divider Ratio} \times (\text{Coarse} \times \text{Line Length} + \text{Fine}) \times (\text{CLKI clock period})$$

Register Index	Bits	Function	Default	Comment
32	0:0	Fine MSB exposure value	0	Maximum Line Length Mode Dependant
33	7:0	Fine LSB exposure value		
34	0:0	Coarse MSB exposure value	302	Maximum equals Field Length-1.
35	7:0	Coarse LSB exposure value		
36	3:0	Gain value	0	
37	1:0	Clock divisor value	0	

Table 4.1 : Exposure, Clock Rate and Gain Registers

If an exposure value is loaded outwith the valid ranges listed in the above table the value is clipped to lie within the above ranges.

Exposure and gain values are re-timed within the sensor to ensure that a new set of values is only applied to the sensor array at the start of each frame. Bit 0 of the Status Register is set high when a new exposure value is written via the serial interface but has not yet been applied to the sensor array.

There is a 1 frame latency between a new exposure value being applied to the sensor array and the results of the new exposure value being read-out. The same latency does not exist for the gain value. To ensure that the new exposure and gain values are aligned up correctly the sensor delays the application of the new gain value by one frame relative to the application of the new exposure value.

To eliminate the possibility of the sensor array seeing only part of the new exposure and gain setting, if the serial interface communications extends over a frame boundary, the internal re-timing of exposure and gain data is disabled while writing data to any location in the Exposure page of the serial interface register map. Thus if the 5 bytes of exposure and gain data is sent as an auto-increment sequence, it is not possible for the sensor to consume only part of the new exposure and gain data.

See also Section 6.6.3.



Gain Binary code	Actual signal gain	Gain Binary code	Actual signal gain
0000 ₂	0.500	1000 ₂	0.533
0001 ₂	1.000	1001 ₂	1.143
0010 ₂	0.667	1010 ₂	0.727
0011 ₂	2.000	1011 ₂	2.667
0100 ₂	0.571	1100 ₂	0.615
0101 ₂	1.333	1101 ₂	1.600
0110 ₂	0.800	1110 ₂	0.889
0111 ₂	4.000	1111 ₂	8.000

Table 4.2 : System Analog Gain Values

Clock Divisor Setting	Pixel Clock Divisor
00 ₂	2
01 ₂	4
10 ₂	8
11 ₂	16

Table 4.3 : Clock Divisor Values



5. Digital Video Interface Format

5.1 General description

The video interface consists of a unidirectional, tri-stateable 4-wire data-bus. The nibble transmission is synchronised to the rising edge of the system clock.

Read-out Order	Progressive Scan (Non-interlaced)
Form of encoding	Uniformly quantised, PCM, 8 bits per sample
Correspondence between video signal levels and quantisation levels:	Internally valid pixel-data is clipped to ensure that 00 _H and FF _H values do not occur when pixel-data is being output on the data-bus. This gives 254 possible values for each pixel (1 - 254). The video black level corresponds to code 16.

Table 5.1 : Video encoding parameters

Digital video-data is 8 bits per sample, and can be transmitted in one of three ways:

1. A series pair of 4-bit nibbles, most significant nibble first, on 4-wires
2. Four 2-bit values, most significant 2-bit value first, on 2-wires
3. Bit-serial data, eight 1-bit values, least significant bit first, on 1-wire.

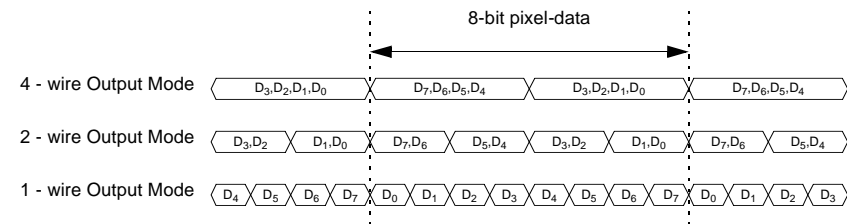

Figure 5.1 : 4-wire, 2-wire and 1-wire Output Modes

In the following description the 4-wire mode is used as an example. The 2-wire, and 1-wire modes can be viewed as variants of the 4-wire mode.

Control information is multiplexed with the sampled pixel-data. Such control information includes both video timing references, sensor status/configuration data and digitised values for VV5409's analogue input pin, AIN.

Video timing reference information takes the form of field start characters, line start characters, end of line characters and a line counter.

5.2 Embedded control data

To distinguish the control data from the sampled video data all control data is encapsulated in embedded control sequences. These are 6 bytes long and include a combined escape/sync character, 1 control byte (the 'command byte') and 2 bytes of supplementary data.

To minimise the susceptibility of the embedded control data to random bit errors redundant coding techniques have been used to allow single bit errors in the embedded control words to be corrected. However, more serious corruption of control words or the corruption of escape/sync characters cannot be tolerated without loss of sync to the data stream. To ensure that a loss of sync is detected a simple set of rules has been devised. The four exceptions to the rules are outlined below:

1. Data containing a command words that has two bit errors.
2. Data containing two 'end of line' codes that are not separated by a 'start of line' code.
3. Data preceding an 'end of field' code before a start of frame' code has been received.
4. Data containing line that do not have sequential line numbers (excluding the 'end of field' line).

If the video processor detects one of these violations then it should abandon the current field of video

5.2.1 The combined escape and sync character

Each embedded control sequence begins with a combined escape and sync character that is made up of three words. The first two of these are FF_H FF_H - constituting two words that are illegal in normal data. The next word is 00_H - guaranteeing a clear signal transition that allows a video processor to determine the position of the word boundaries in the serial stream of nibbles. Combined escape and sync characters are always followed by a command byte - making up the four byte minimum embedded control sequence.

5.2.2 The command word

The byte that follows the combined escape/sync characters defines the type of embedded control data. Three of the 8 bits are used to carry the control information, four are 'parity bits' that allow the video processor to detect and correct a certain level of errors in the transmission of the command words, the remaining bit is always set to 1 to ensure that the command word is never has the value 00_H. The coding scheme used allows the correction of single bit errors (in the 8-bit sequence) and the detection of 2 bit errors. The three data bits of the command word are interpreted as shown in Figure 5.2. The even parity bits are based on the following relationships:

1. An even number of ones in the 4-bit sequence (C₂, C₁, C₀ and P₀).
2. An even number of ones in the 3-bit sequence (C₂, C₁, P₁).
3. An even number of ones in the 3-bit sequence (C₂, C₀, P₂).
4. An even number of ones in the 3-bit sequence (C₁, C₀, P₃).

Table 5.3 shows how the parity bits maybe used to detect and correct 1-bit errors and detect 2-bit errors.

5.2.3 Supplementary Data

The last 2 bytes of the embedded control sequence contains supplementary data. Three options:

1. The current 12-bit line number. The 12-bit line number is packaged up by splitting it into two 6-bit values. Each 6-bit values is then converted into an 8-bit value by adding a zero to the start and an odd word parity bit at the end.
2. If the line code equals the end of line, the 2 bytes are padded out using null characters (FF_H).
3. If the line code equals the end of line and digitise analogue input enabled then the 2 supplementary data bytes contain 2 8-bit values representing the values of the analogue input at those two points in time.

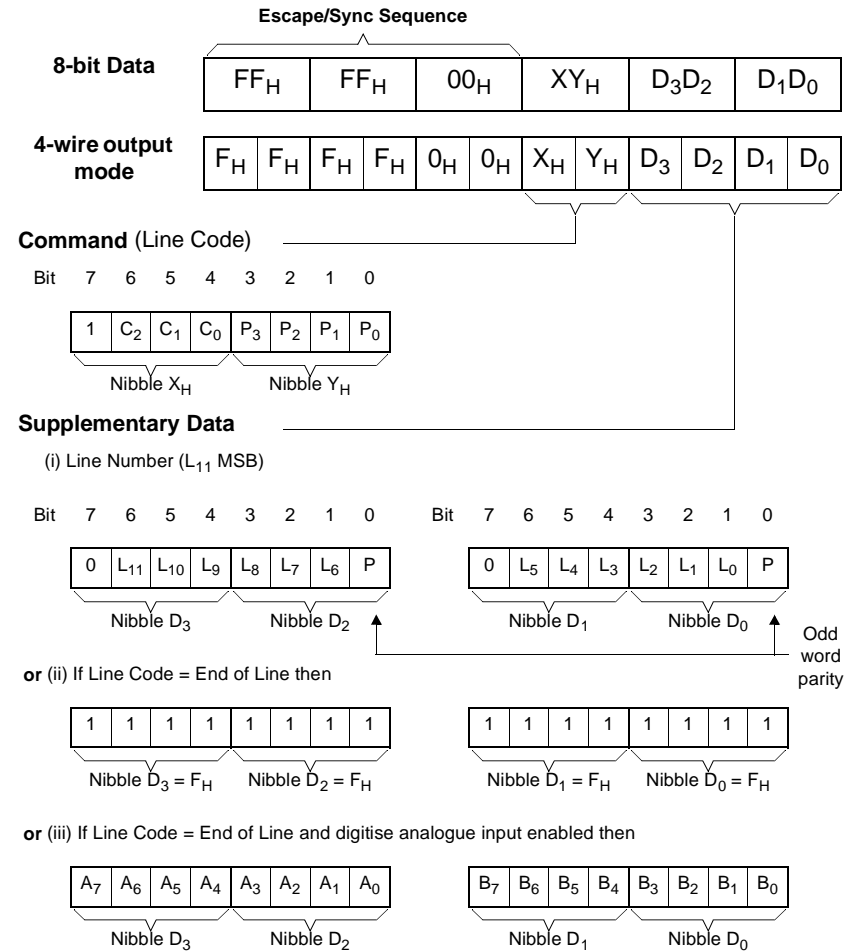

Figure 5.2 : Embedded Control Sequence

Line Code	Nibble X _H (1 C ₂ C ₁ C ₀)	Nibble Y _H (P ₃ P ₂ P ₁ P ₀)
End of Line	1000 ₂ (8 _H)	0000 ₂ (0 _H)

Table 5.2 : Embedded Line Codes



Line Code	Nibble X _H (1 C ₂ C ₁ C ₀)	Nibble Y _H (P ₃ P ₂ P ₁ P ₀)
Blank Line (BL)	1001 ₂ (9 _H)	1101 ₂ (D _H)
Black line (BK)	1010 ₂ (A _H)	1011 ₂ (B _H)
Visible Line (VL)	1011 ₂ (B _H)	0110 ₂ (6 _H)
Start of Even Field (SOEF)	1100 ₂ (C _H)	0111 ₂ (7 _H)
End of Even Field (EOEF)	1101 ₂ (D _H)	1010 ₂ (A _H)
Start of Odd Field (SOOF)	1110 ₂ (E _H)	1100 ₂ (C _H)
End of Odd Field (EOOF)	1111 ₂ (F _H)	0001 ₂ (1 _H)

Table 5.2 : Embedded Line Codes

Parity Checks				Comment
P ₃	P ₂	P ₁	P ₀	
4	4	4	4	Code word un-corrupted
4	4	4	8	P ₀ corrupted, line code OK
4	4	8	4	P ₁ corrupted, line code OK
4	8	4	4	P ₂ corrupted, line code OK
8	4	4	4	P ₃ corrupted, line code OK
8	8	4	8	C ₀ corrupted, invert sense of C ₀
8	4	8	8	C ₁ corrupted, invert sense of C ₁
4	8	8	8	C ₂ corrupted, invert sense of C ₂
All other codes				2-bit error in code word.

Table 5.3 : Detection of 1-bit and 2-bit errors in the Command Word

5.3 Video timing reference and status/configuration data

Each frame of video sequence is made up of 2 fields. Each field of data is constructed of the following sequence of data-lines.

1. A start-of-field line
2. 2 'black lines' (used for black level calibration)
3. A number of blank lines
4. A number active video lines
5. An end of field line
6. A number of blank lines.



	Video Format	NTSC		PAL		CIF	
	Border Lines	On	Off	On	Off	On	Off
1st Field	Start-of-field Line	1	1	1	1	1	1
	Black Lines	2	2	2	2	2	2
	Blanking Lines	7	9	7	9	7	9
	Active Video lines	244	240	292	288	292	288
	End of Field Line	1	1	1	1	1	1
	Blanking Lines	7	9	9	11	1	3
	Total	262	262	311	311	304	304
2nd Field	Start-of-field Line	1	1	1	1	1	1
	Black Lines	2	2	2	2	2	2
	Blanking Lines	7	9	7	9	7	9
	Active Video lines	244	240	292	288	292	288
	End of Field Line	1	1	1	1	1	1
	Blanking Lines	8	10	10	12	1	3
Total	263	263	312	312	304	304	

Table 5.4 : Field and Frame Formats

Table 5.4 details the number of each type of data-lines for NTSC, PAL and CIF output formats when the border rows and columns, are output, and not output, on the data-bus.

Each line of data starts with an embedded control sequence, which identifies the line type (as outlined in Table 5.2). The control sequence is then followed by two bytes which, except in the case of the end-of-frame line, contain a coded line number. The line number sequences starts with the start-of-frame line at 00_H, and increments, one per line, until the end-of-frame line. Each line is terminated with an end-of-line embedded control sequence. The line start embedded sequences, must be used to recognise data-lines, as a number of null bytes may be inserted between data-lines.

5.3.1 Blank lines

In addition to padding between data-lines, actual blank data-lines may appear in the positions indicated above. These lines begin with start-of-blank-line embedded control sequences, and are constructed identically to active video lines except that they will contain only blank bytes (07_H).

5.3.2 Black line timing

The black lines (which are used for black level calibration) are identical in structure to valid video lines except that they begin with a start-of-black line sequence and contain either information from the sensor 'black lines' or blank bytes (07_H).

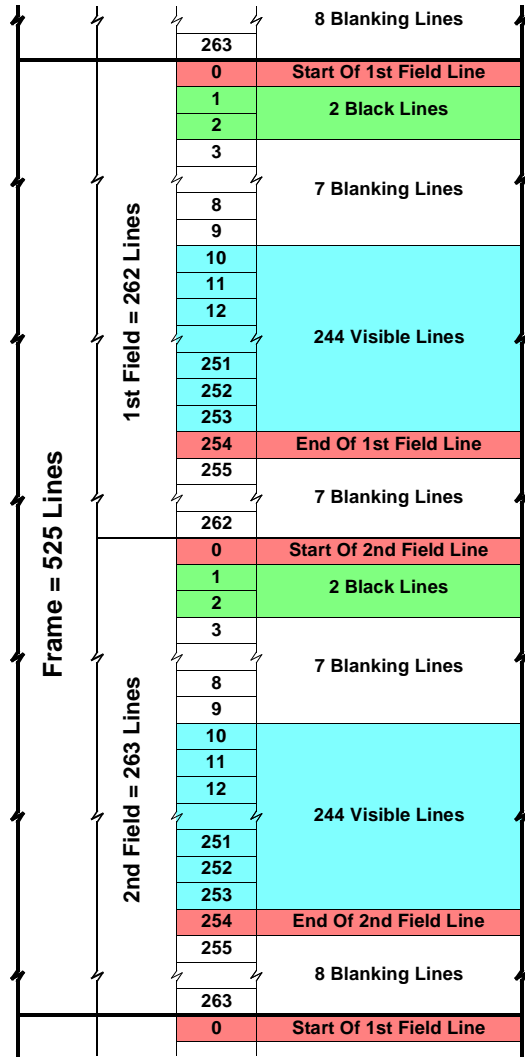

Figure 5.3 : NTSC Field and Frame Formats - Borders On, Extra Black Lines Off

Commercial In Confidence

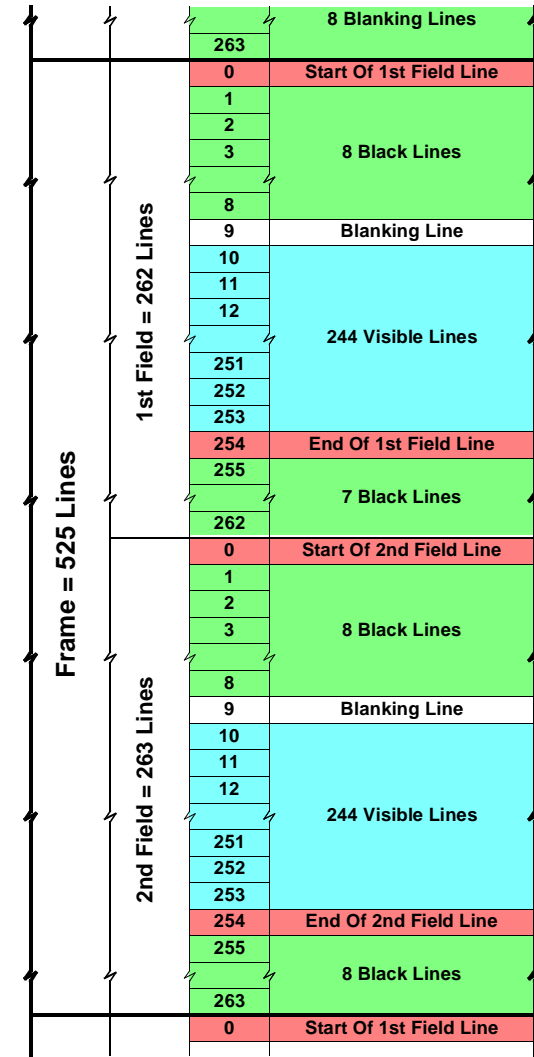

Figure 5.4 : NTSC Field and Frame Formats - Borders On, Extra Black Lines On

Commercial In Confidence

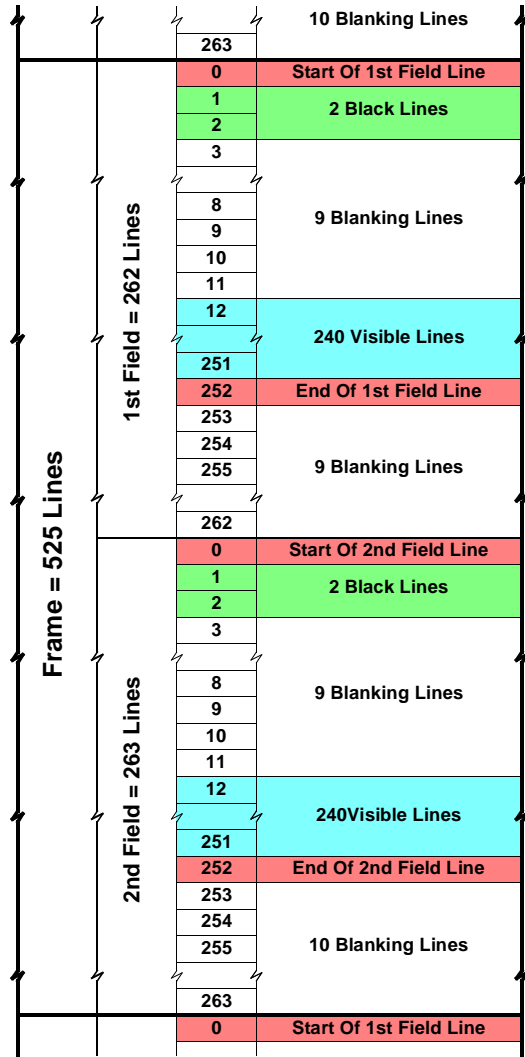

Figure 5.5 : NTSC Field and Frame Formats - Borders Off, Extra Black Lines Off

Commercial In Confidence

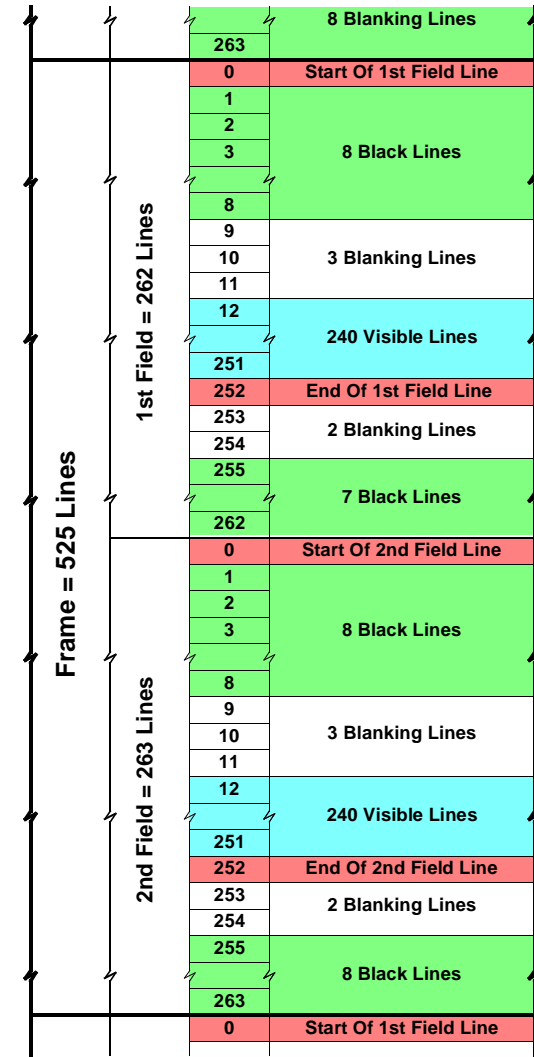

Figure 5.6 : NTSC Field and Frame Formats - Borders Off, Extra Black Lines On

Commercial In Confidence

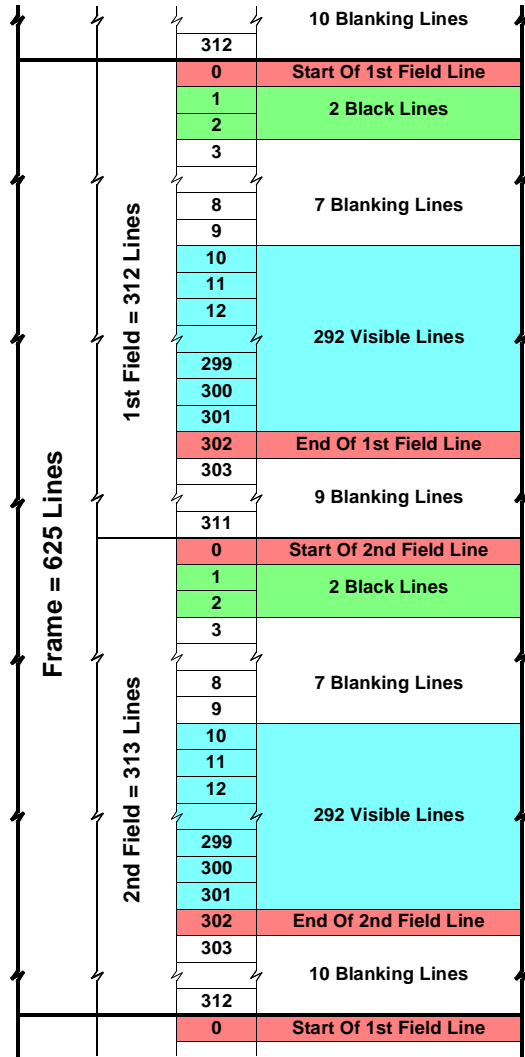

Figure 5.7 : PAL Field and Frame Formats - Borders On, Extra Black Lines Off

Commercial In Confidence

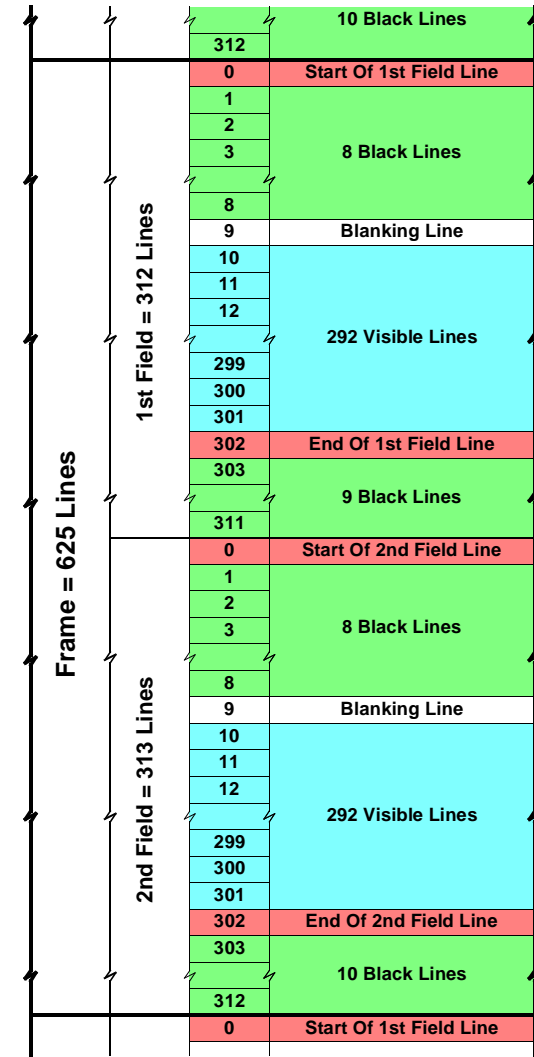

Figure 5.8 : PAL Field and Frame Formats - Borders On, Extra Black Lines On

Commercial In Confidence

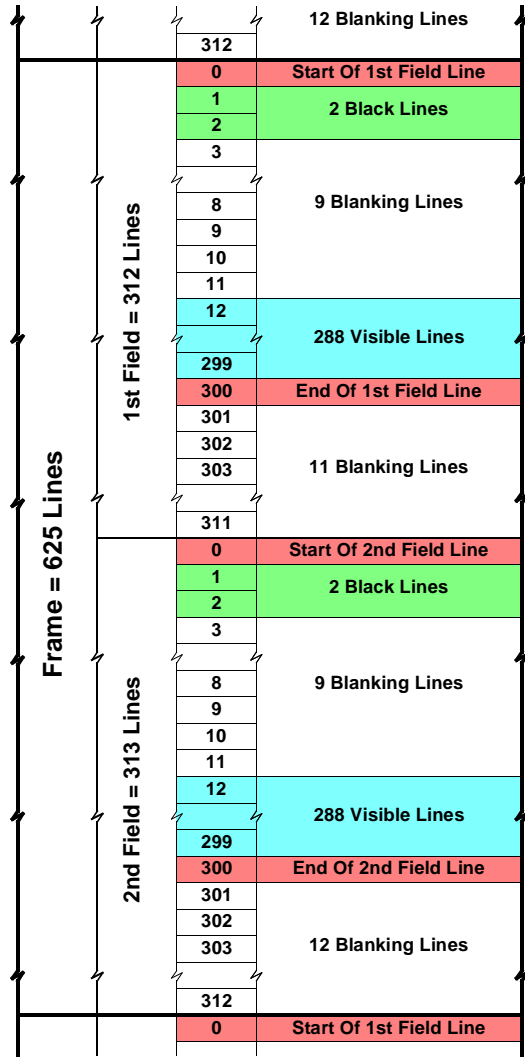

Figure 5.9 : PAL Field and Frame Formats - Borders Off, Extra Black Lines Off

Commercial In Confidence

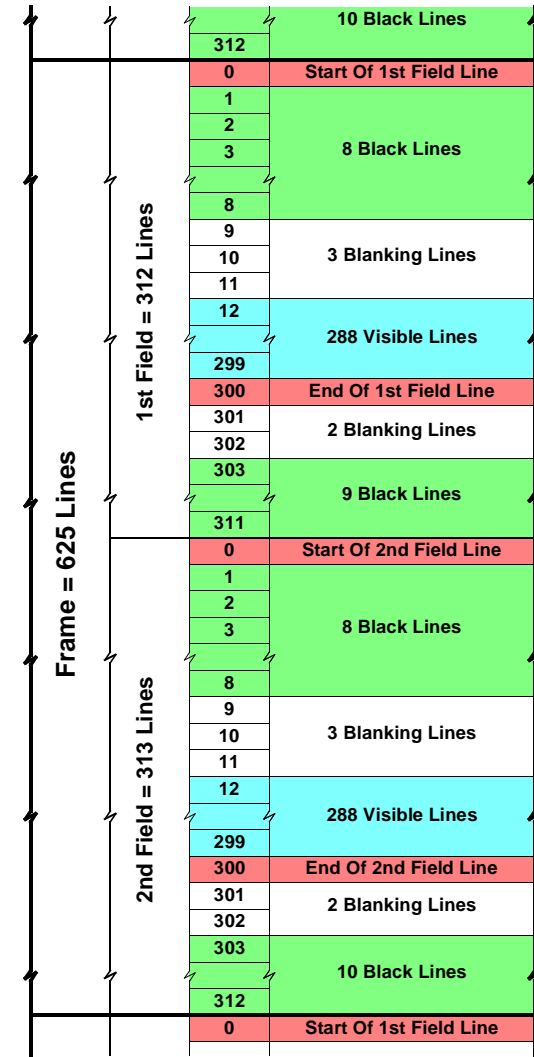

Figure 5.10 : PAL Field and Frame Formats - Borders Off, Extra Black Lines On

Commercial In Confidence

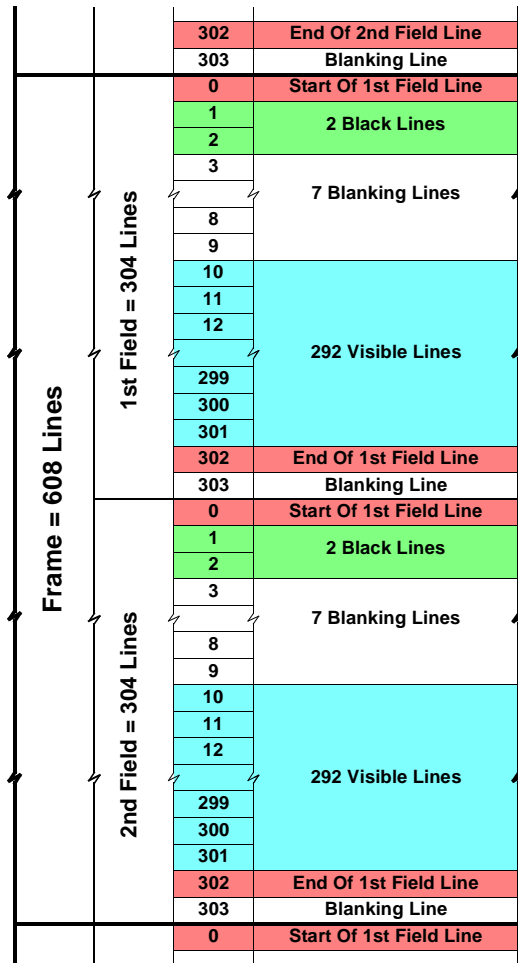

Figure 5.11 : CIF Field and Frame Formats - Borders On, Extra Black Lines Off

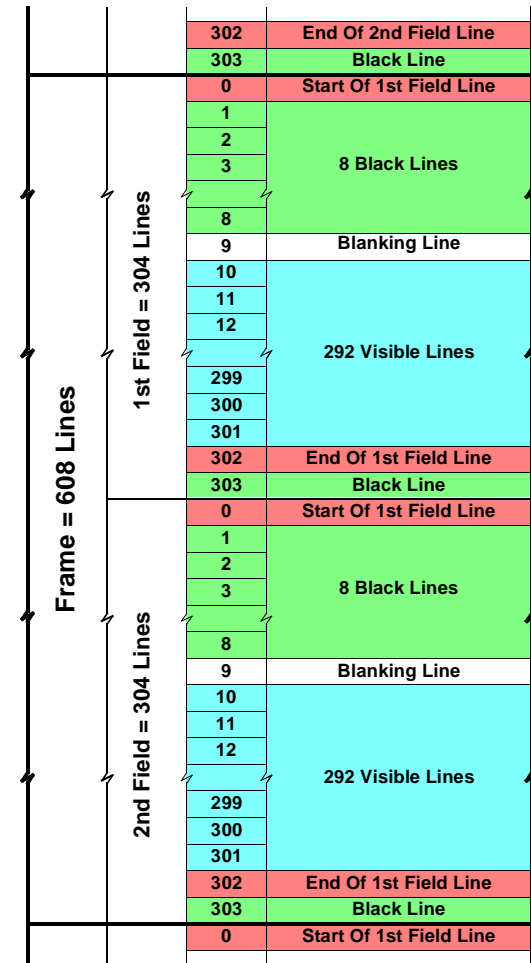

Figure 5.12 : CIF Field and Frame Formats - Borders On, Extra Black Lines On

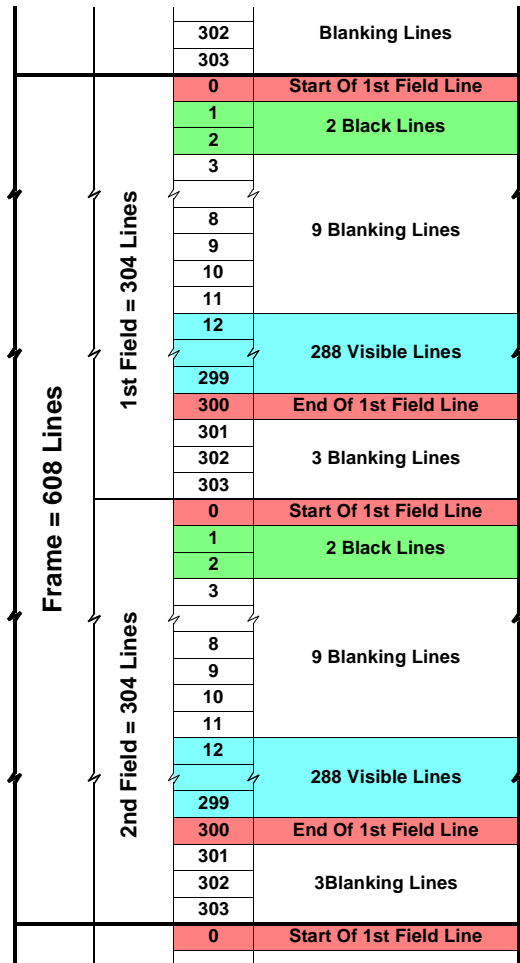

Figure 5.13 : CIF Field and Frame Formats - Borders Off, Extra Black Lines Off

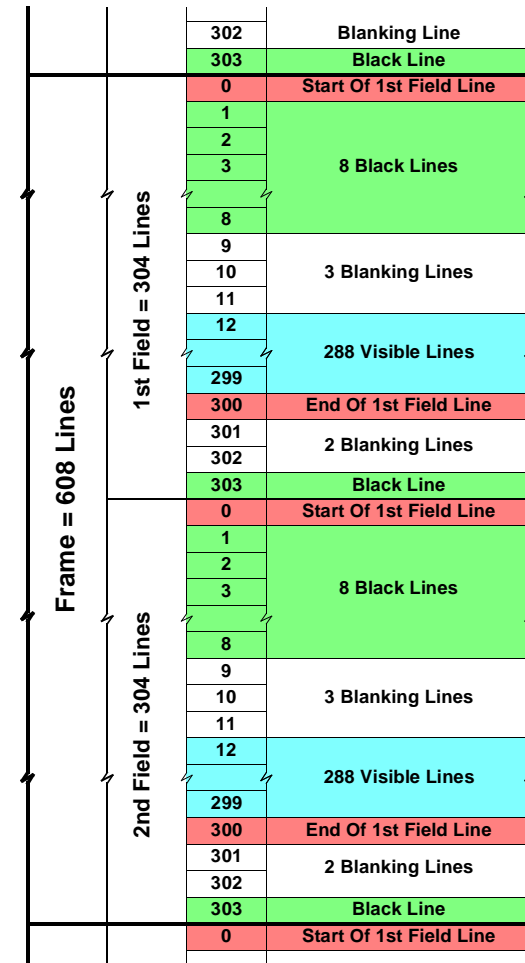

Figure 5.14 : CIF Field and Frame Formats - Borders Off, Extra Black Lines On

5.3.3 Valid video line timing

All valid video data is contained on active video lines. The pixel data appears as a continuous stream of bytes

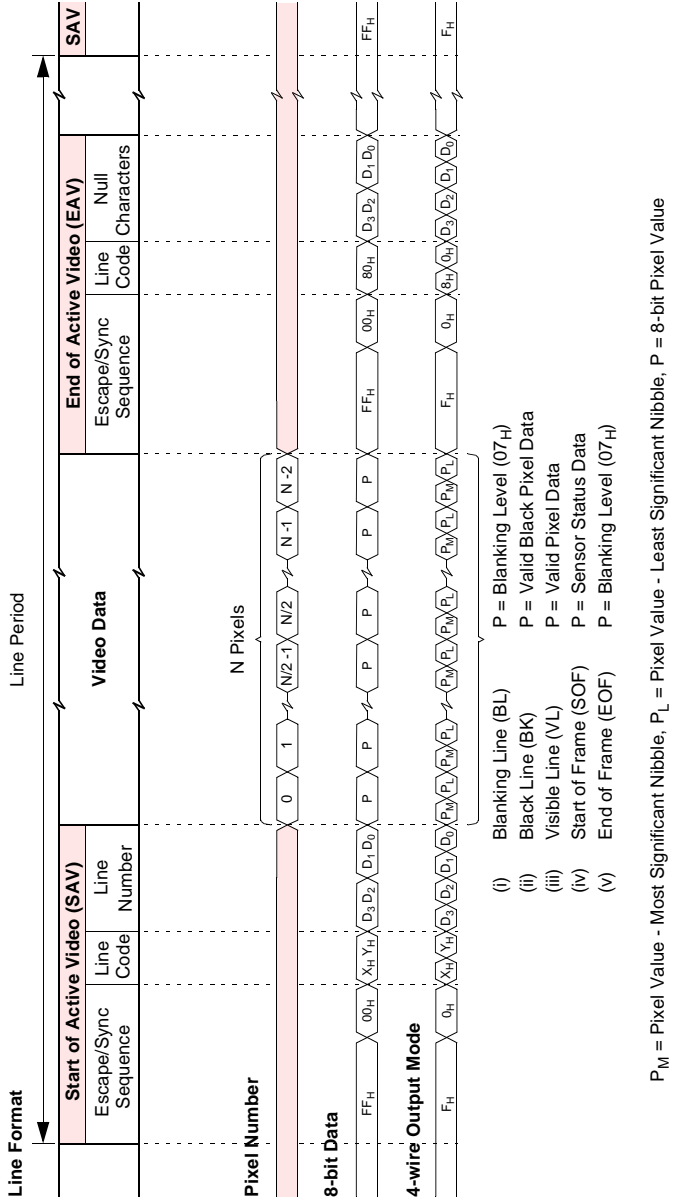

Figure 5.15 : Line Data Format

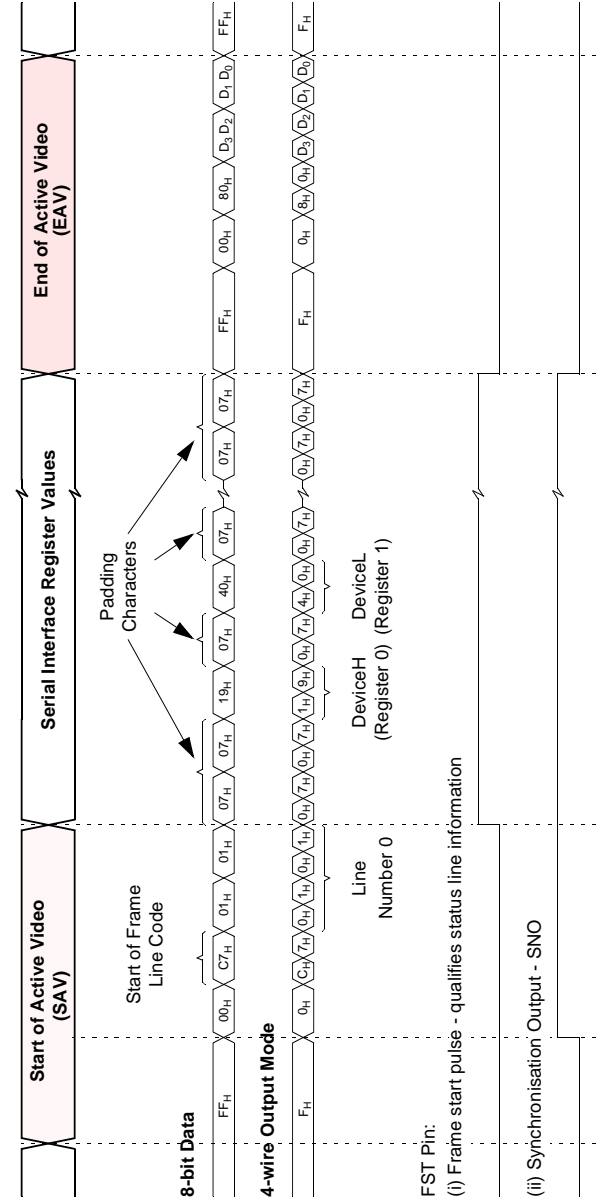

Figure 5.16 : Status Line Data Format and FST/SNO Signals

within the active lines. The pixel data may be separated from the line header and end-of-line control sequence by a number of 'blank' bytes (07_H) e.g. when the border lines and pixels are disabled 07_H is output in place of first 2 and last 2 pixels in a valid video line.

5.3.4 Start of frame line timing

The start of frame line which begins each video field contains no video data but instead contains the contents of all the serial interface registers. This information follows the start-of-line header immediately and is terminated by an end-of-line control sequence. To ensure that no escape/sync characters appear in the sensor status/configuration information the code 07_H is output after each serial interface value. Thus it takes 256 pixel clock periods (512 system clocks) to output all 128 of the serial interface registers. The remainder of the 356 pixel periods of the video portion of the line is padded out using 07_H values. The first two pixel locations are also padded with 07_H characters (Figure 5.16)

If a serial interface register location is unused then 07_H is output.

5.3.5 End of frame line timing

The end of frame line which begins each video field contains no video data. Its sole purpose is to indicate the end of a frame.

5.4 Detection of sensor using data bus state

The video processor device must have internal pull-down terminations on the data bus. On power-up a sensor will pull all data lines high for a guaranteed period. This scheme allows the presence of a sensor on the interface to be detected by the video processor on power-up, and the connection of a sensor to an already power-up interface (a 'hot' connection).

The absence of a sensor is detected by the video processor seeing more than 32 consecutive nibbles of 0_H on the data bus. On detecting the absence of a sensor, CKI, should be disabled (held low).

The presence of a sensor is detected by the video processor seeing more than 32 consecutive nibbles of F_H on the data bus. On detecting the presence of a sensor, CKI, should be enabled.

5.5 Resetting the Sensor Via the Serial Interface

Bit 2 of setup register 0 allows the VV5409 sensor to be reset to its power-on state via the 2-wire serial interface. Setting this "Soft Reset" bit causes all of the serial interface registers including the "Soft Reset" bit to be reset to their default values. This "Soft Reset" leaves the sensor in low-power mode and thus an "Exit Low-Power Mode" command (Table 6.7, Section 6.6.2) must be issued via the serial interface before the sensor will start to generate video data (Figure 5.17).

5.6 Power-up, Low-power and Sleep modes

To clarify the state of the interface on power-up and in the case of a 'hot' connection of the interface cable the power-up state of the bus is defined below.

PU0	System Power Up or Sensor Hot Plugged
PU1	Sensor Internal-on Reset Triggers, the sensor enters low power mode and D[3:0] is set to F _H .
PU2	Video Processor released from reset.
PU3	Video Processor enables the sensor clock, CLKI.

Table 5.5 : System Power-Up or Hot-plugging Device Behaviour

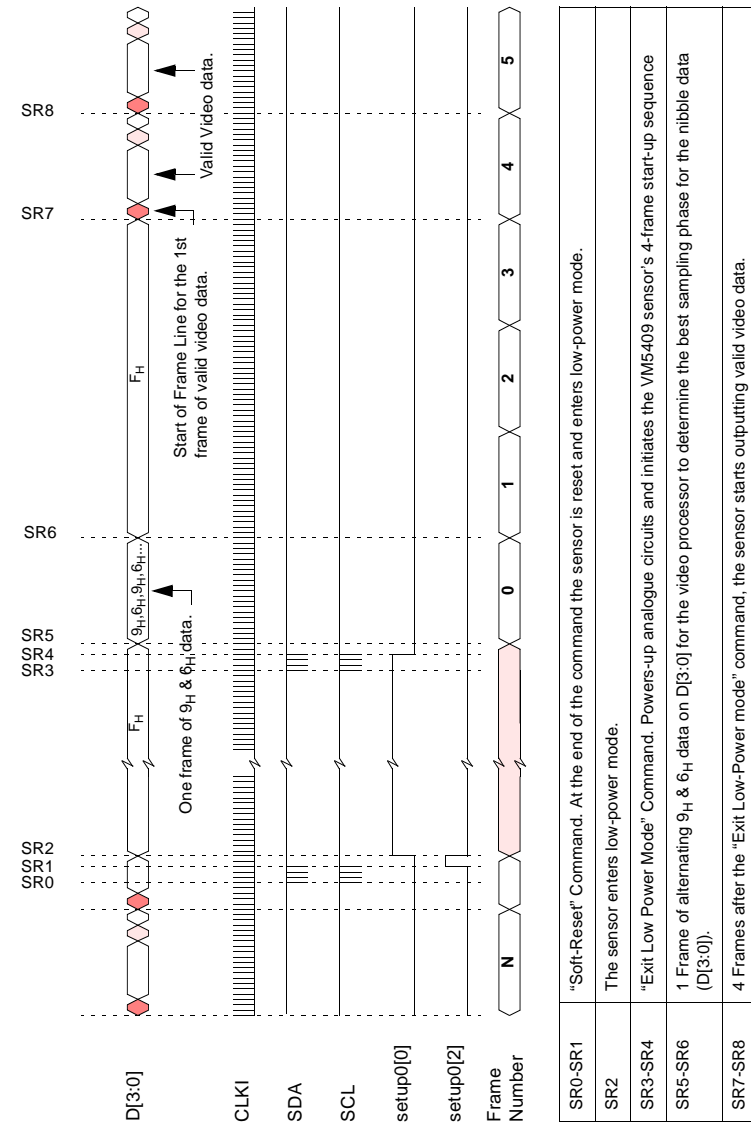

Figure 5.17 : Resetting the VV5409 Sensor via the Serial Interface



PU4-PU5	At least 16 CLKI clock periods after CLKI has been enabled the host controller must send a "Soft-Reset" command to the sensor via the serial interface. This ensures that if a sensor is present then it is in low-power mode.
PU6	On detecting 32 consecutive FF _H (F _H) values on the data bus, the Video Processor sets the no_camera low.
PU7-PU8	Initiate the Auto-load Daisy-Chain (only where a VISION co-processor is used) to read setup data and the sensor defect map from the appropriate serial E ² PROMs into the sensor and co-processor.
PU9	Video Processor disables the sensor clock, CLKI.
PU10	Video Processor generates the VP_Ready interrupt.
PU11	The host software services the VP_Ready interrupt.
PU12	Host issues command to remove sensor from low-power mode. co-processor/host controller enables the sensor clock, CLKI.
PU13-PU4	At least 16 CLKI clock periods after CLKI has been enabled the host controller must send the "Exit Low-Power Mode" command to the sensor via the serial interface. This initiates the sensors 4 frame start sequence.
PU15-PU16	One frame of alternating 9 _H & 6 _H data on D[3:0] for the video processor to determine the best sampling phase for the nibble data (D[3:0]).
PU17-PU18	4 Frames after the "Exit Low-Power Mode" serial comms, the sensor starts outputting valid video data.

Table 5.5 : System Power-Up or Hot-plugging Device Behaviour

5.6.1 Power-Up/Down (Figure 5.18)

There are two options:

1. Sensor starts running on power-up.
2. Sensor enters low-power after power-up.

The choice of which state the sensor is in on power-up depends of the values of the mode select pins on power-up

When the sensor starts running on power-up, the power-up sequence is as follows:

1. One field of a continuous stream of alternating 9_H and 6_H values on the data bus. By locking onto the resulting 0101/1010 patterns appearing on the data bus lines the video processor can determine the best sampling position for the video data stream.
2. 3 Fields of constant FF_H (F_H) on the data bus
3. 4 Fields after power-up valid video data is generated.

In the case of the sensor entering low-power mode on power-up, the sequence to exit low power-mode is as follows.

On power-up all of the data bus lines will go high Immediately FF_H (F_H) to indicate that the device is "present" and the device enters it low-power mode (Section 5.6.2).

When the Video Processor is reset the following sequence should be executed to ensure that the VM5409 starts to generate video data:

1. After the Video Processor has been released from reset, the sensor clock, CLKI, should be enabled immediately
2. After waiting for at least 16 CLKI clock cycles, a "Soft Reset" command should be issued to the sensor. This is necessary to ensure that the sensor is brought into a known state. If the sensor is not present

Commercial In Confidence

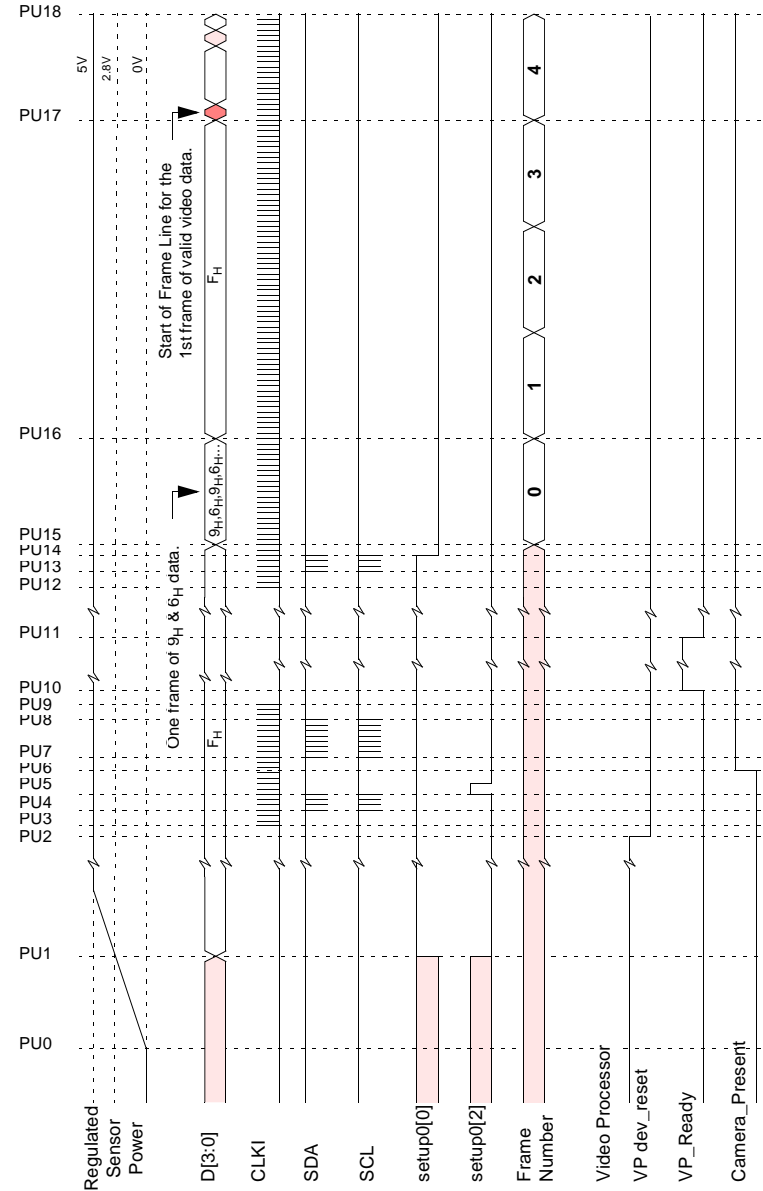

Figure 5.18 : System Power-Up or Hot-plugging Device Behaviour

Commercial In Confidence

then the serial interface communications by Video Processor will not be acknowledged.

3. Poll for 32 consecutive F_H values on the data bus, if this condition is satisfied then the sensor is present. The Video processor should set the camera_present flag.
4. Initiate the Auto-load daisy-chain to read setup data and the defect data from the appropriate serial CMOS E²PROMs into the sensor and co-processor as appropriate (only where a VISION co-processor is used).
5. Disable the sensor clock CKI.
6. The Video Processor should generate the VP_Ready interrupt.
7. Once the host software serviced the VP_Ready interrupt, then the sensor and video processor is ready to generate video data.
8. To enable video data, the host software, sets the low-power mode bit low. The video processor must enable CLKI at least 16 CLKI clock cycles before issuing the "Exit Low-Power Mode" command via the serial interface.

After the "Exit Low-Power Mode" command has been sent the sensor will output for one frame, a continuous stream of alternating 9_H and 6_H values on D[3:0]. By locking onto the resulting 0101/1010 patterns appearing on the data bus lines the video processor can determine the best sampling position for the nibble data. After the last 9_H 6_H pair has been output the data bus returns to F_H until the start of fifth frame after CKI has been enabled when the first active frame output. After the video processor has determined the correct sampling position for the data, it should then wait for the next start of frame line (SOF).

If the video processor detects 32 consecutive 0_H values on the data bus, then the sensor has been removed. The sensor clock, CKI, should be held low.

5.6.2 Low-Power Mode

Under the control of the serial-interface, the sensor's analogue circuitry can be powered-down, and then powered-up. When the low-power bit is set through the serial-interface, all the data-bus lines will go high at the end of the current frame's, end-of-frame line. At this point the analogue circuits in the sensor, will power-down. The system clock must remain active for the duration of low power mode.

Only the analogue circuits are powered-down, the values of the serial-interface registers e.g. exposure, and gain are preserved.

The internal frame timing is reset to the start of a video frame, on exiting low-power mode.

In a similar manner to the previous section, the first frame after the serial comms contains a continuous stream of alternating 9_H and 6_H to allow the video processor to re-confirm its sampling position. Then three frames later the first start-of-frame line is generated.

5.6.3 Sleep Mode

Sleep mode is similar to the low-power mode, except that the analogue circuitry remains powered. When the sleep command is received through the serial-interface, the pixel-array will be put into reset, and all the data-lines will go high at the end of the current frame. Again the system clock must remain active for the duration of the sleep mode.

When the sleep mode is disabled, the CMOS sensor's frame timing, is reset to the start of a frame. During the first frame, after exiting from the sleep mode, the data-bus will remain high, while the exposure value propagates through the pixel-array. At the start of the second frame, the first start-of-field line will be generated.

5.6.4 Application of the system clock during sensor low-power modes

For successfully entry and exit into and out of low power and 'sleep' modes the system clock, CLKI, must remain active for the duration of these modes.

5.7 Qualification of Output Data

There are two distinct ways for qualifying the data nibbles appearing of the output data bus

5.7.1 Using the External Clock signal applied to CLKI

The data on the output data bus, changes on the rising edge of CLKI. The delay between the video processor supplying a rising clock edge and the data on the data bus becoming valid, depends on the length of the cable between the sensor and the video processor. To allow the video processor to find the best sampling position for the data nibbles, via the serial interface the data bus can be forced to output continuously 9_H , 6_H , 9_H , 6_H ,...

5.7.2 Data Qualification Clock, QCK

VV5409 provides a data qualification clock for the output bus There are two frequencies for the qualification clock: one runs at the nibble rate and the other at the pixel read-out rate. The falling edge of the fast QCK qualifies every nibble irrespective of whether it is most or least significant nibble. For the slow QCK, the rising edge qualifies the most significant nibbles in the output data stream and the falling edge qualifies the least significant nibbles in the output data stream.

There are 4 modes of operation of QCK.

1. Disabled (Always low - (Default)
2. Free running - qualifies the whole of the output data stream.
3. Embedded control sequences, status data and pixel data.
4. Pixel Data Only.

The operating mode for QCK is set via the serial interface. The QCK output is tri-stated when OEB is high. In one of the modes available via the serial interface the slow version of QCK will appear on the QCK pin while the fast version of the same signal will appear on the FST pin.

In the case where the border rows and columns are disabled, there is simply no qualification pulse at that point in time i.e. when pixels 0,1, 354 and 355 are normally output.

The QCK pin can also be configured to output the state of a serial interface register bit. This feature allows the sensor to control external devices, e.g. stepper motors, shutter mechanisms. The configuration details for QCK can be found in sections 5.5.7 and 5.5.8 of this document.

5.7.3 Line Start Signal, LST

There are 4 modes of operation for the LST pin programmable via the serial interface:

1. Disabled (Always Low- Default).
2. Free running - LST signal occurs once at the beginning of every line.
3. All lines except blanking lines are qualified by LST.
4. Only Black and Visible Lines are qualified by LST.

The LST is tri-stated when OEB is high.

5.7.4 Frame Start Signal, FST

There are 3 modes of operation for the FST pin programmable via the serial interface:

1. Disabled (Always Low- Default).
2. Frame start signal. The FST signal occurs once frame, is high for 356 pixel periods (712 system clock periods) and qualifies the data in the start of frame line.
3. Synchronisation Output Pulse -SNO - Refer to Section 8. on Synchronising multiple cameras.
4. As the de-bounced switch input.

Note: The function of the SNO pin has not been verified.

The FST is tri-stated when OEB is high.

The FST pin can also be configured to output the state of a serial interface register bit. This feature allows

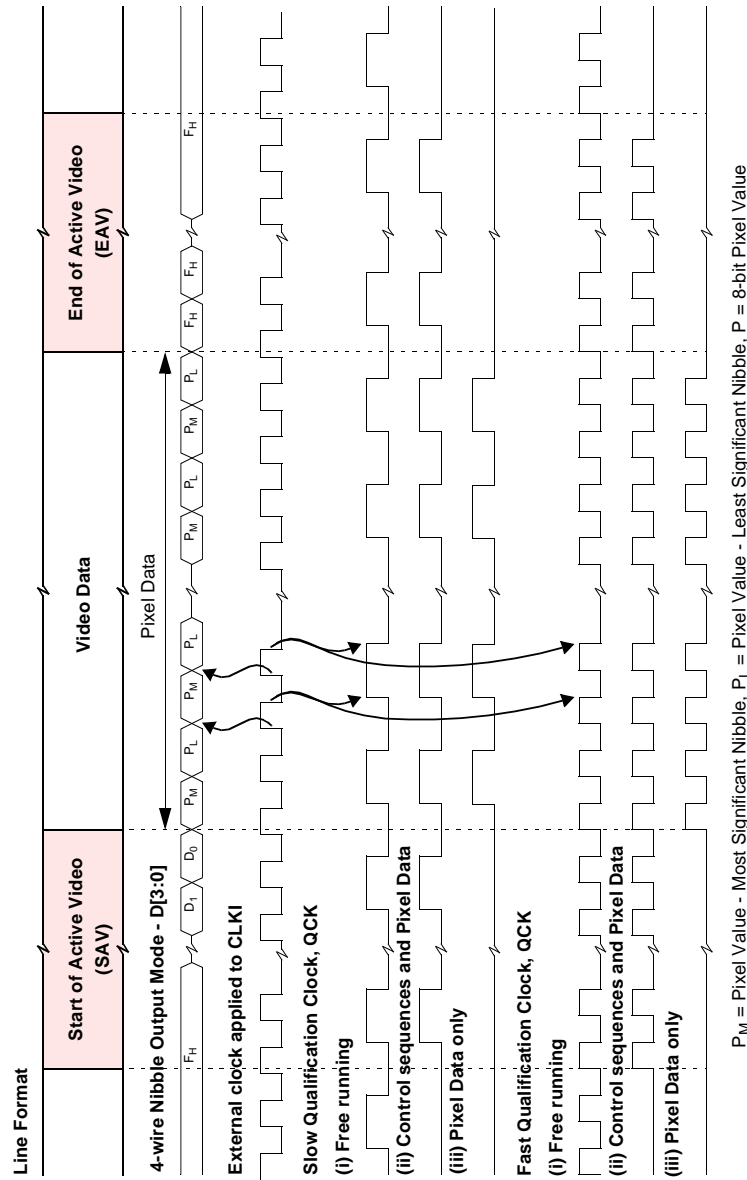

P_M = Pixel Value - Most Significant Nibble, P_L = Pixel Value - Least Significant Nibble, P = 8-bit Pixel Value

Figure 5.19 : Qualification of Output Data (Border Rows and Columns Enabled)

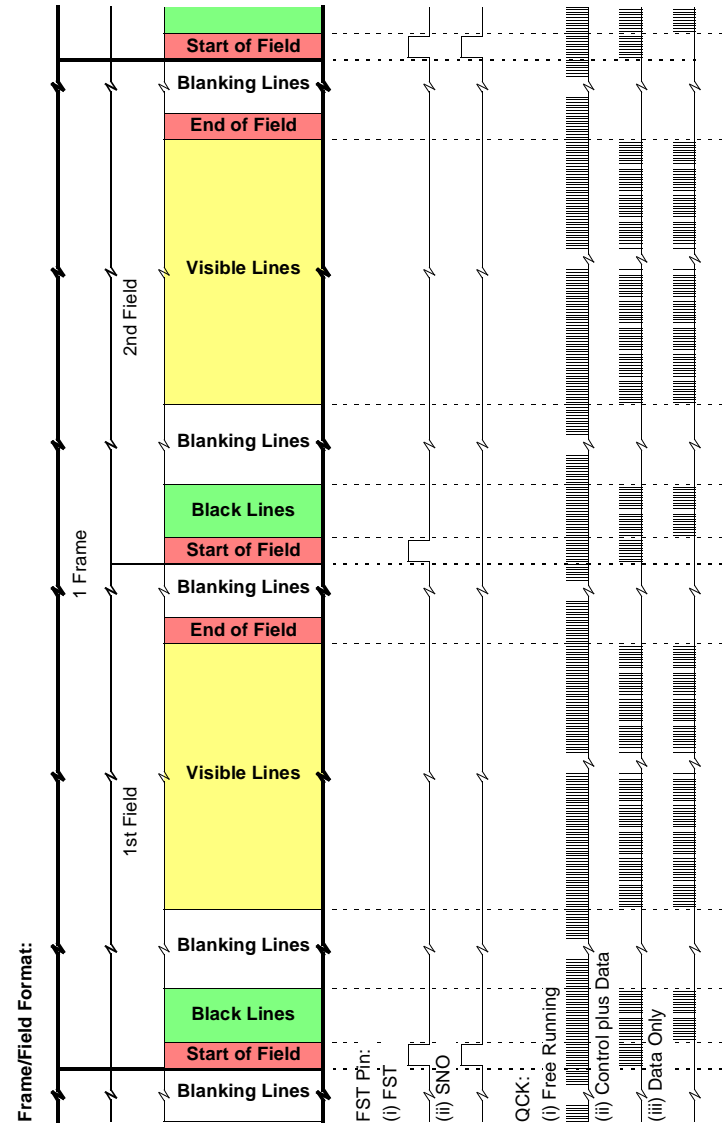

Figure 5.20 : Frame/Field Level Timings for FST and QCK

the sensor to control external devices, e.g. stepper motors, shutter mechanisms.

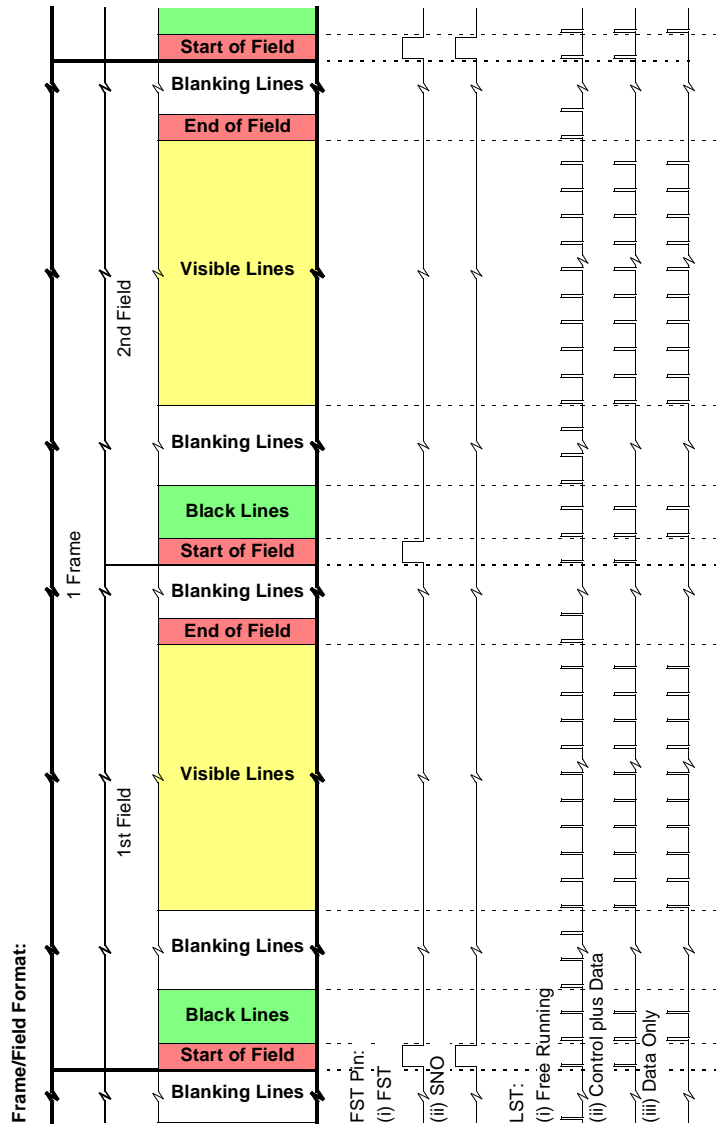

Figure 5.21 : Frame/Field Level Timings for FST and LST

The configuration details for FST can be found in Section 6.6.2 of this document.

Commercial In Confidence

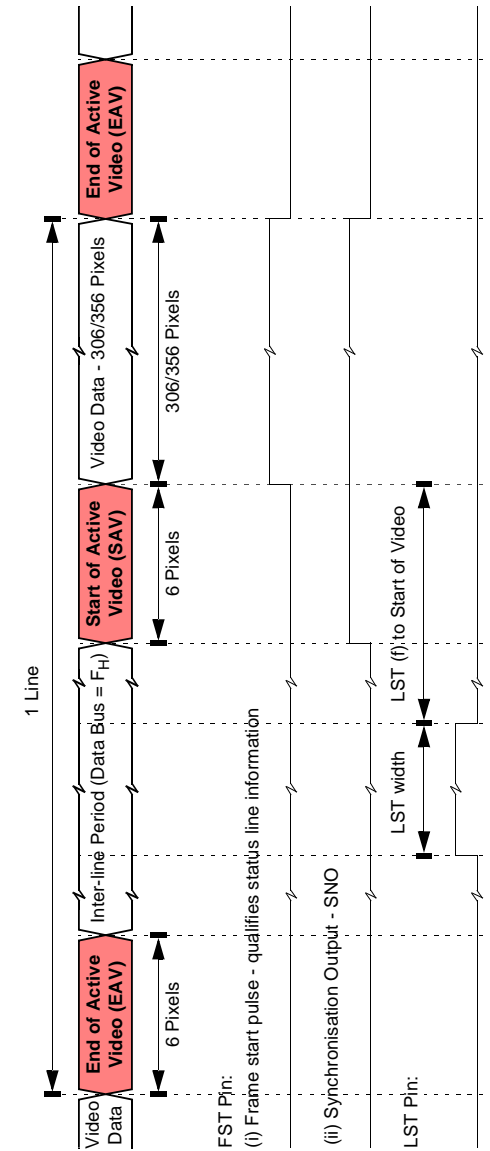

Figure 5.22 : Line Level Timings for FST and LST

Commercial In Confidence

6. Serial Control Bus

Note: Where 'Recommended settings' are given in Section 6.5 and Section 6.6, it is recommended that these settings are written to the camera registers on startup, for correct operation of the sensor. This applies to the Setup0 [16], Setup1 [17], and at1 [121] registers in particular.

6.1 General Description

Writing configuration information to the video sensor, and reading both sensor status, and configuration information, back from the sensor, is performed through the 2-wire serial-interface.

Communication using the serial-control-bus, centres around a number of registers internal to the video sensor. These registers, store the sensor status, set-up, exposure, and system information. Most of the registers are read/write, allowing the receiving equipment to change their contents. Others (such as the chip ID) are read only.

The main features of the serial-interface include:

- Sensor address is now fixed at 20_H/21_H (whereas in VV6407, 2 possible sensor addresses could be set by means of the SA[0] pin)
- Broadcast address, to ease setting up multiple camera configurations
- Variable length read/write messages
- Indexed addressing of information source, or destination within the sensor
- Automatic update of the index, after a read, or write message
- Message abort, with negative acknowledge, from the master
- Byte oriented messages.

The contents of all internal registers, accessible through the serial-control-bus, are encapsulated in each start-of-field line - see Section 5.3.4.

6.2 Serial Communication Protocol

The host controller must perform the role of a communications master, while the camera acts as either a slave receiver, or transmitter. The communication from host to camera, takes the form of 8-bit data, with a maximum serial clock video processor frequency of 100 kHz. Since the serial clock is generated by the bus-master, it determines the data transfer rate. Data transfer protocol on the bus is shown below.

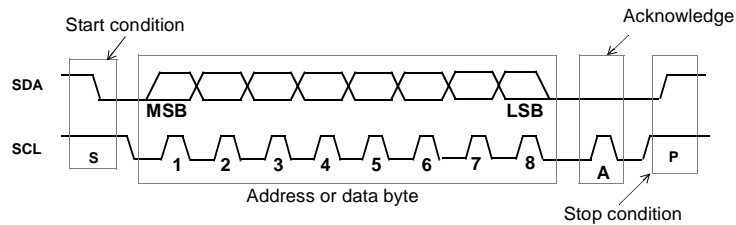

Figure 6.1 : Serial-Interface Data Transfer Protocol

6.3 Data Format

Information is packed in 8-bit packets (bytes) always followed by an acknowledge bit. The internal data is produced by sampling SDA, at a rising edge of SCL. The external data must be stable during the high period of SCL. The exceptions to this are start (S) or stop (P) conditions when SDA falls, or rises respectively, while

Commercial In Confidence

SCL is high.

A message contains at least two bytes, preceded by a start condition, and followed by either a stop, or repeated start, (Sr) followed by another message.

The first byte contains the device address byte, which includes the data direction read, (r), ~write, (~w), bit. The allocation of serial-interface addresses for sensors, VISION co-processors, and serial E²PROMs is defined in Table 6.1. The lsb of the address byte, indicates the direction of the message. If the lsb is set high, the master will read data from the slave, and if the lsb is reset low, the master will write data to the slave. After the r, ~w bit is sampled, the data direction cannot be changed until the next address byte, with a new r, ~w bit is received.

In addition to its own specific address, the VV5409 also responds to the sensor and VISION co-processor; and sensor only, serial-interface addresses. These additional addresses allow sensors and/or VISION co-processors to be written to in parallel, through the serial-interface bus. The broadcast addresses are only intended for writing, not reading.

Serial Address		Comment
1010_XXX_R/W	A0 _H - AF _H	Serial E ² PROM - 8 possible addresses
0010_000_R/W	20 _H - 21 _H	Sensor - address (fixed).
0010_1XX_R/W	28 _H - 2F _H	VISION Co-processor - 4 possible addresses
0011_000_R/W	30 _H & 31 _H	Sensor and VISION Co-processor Broadcast Address
0011_001_R/W	32 _H & 33 _H	Sensor Only Broadcast Address
0011_010_R/W	34 _H & 35 _H	VISION Co-processor Only Broadcast Address

Table 6.1 : Allocation of Serial-Interface Addresses

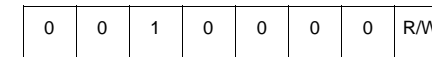

Figure 6.2 : VV5409 Serial Interface Address

The byte following the address byte contains the address of the first data byte (also referred to as the index). The serial-interface, can address up to 128 registers. If the msb of the second byte is set, the automatic increment feature of the address index, is selected.

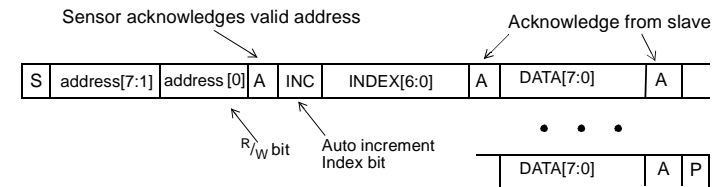

Figure 6.3 : Serial-Interface Data Format

Commercial In Confidence



6.4 Message Interpretation

All serial-interface communications with the sensor, must begin with a *start* condition. If the *start* condition is followed by a valid address byte, further communications can take place. The sensor will acknowledge the receipt of a valid address, by driving the *SDA* wire low. The state of the *read/-write* bit (lsb of the address byte) is stored, and the next byte of data, sampled from *SDA*, can be interpreted.

During a write sequence, the second byte received is an address index, which points to one of the internal registers. The msbit of the following byte, is the *index auto increment* flag. If this flag is set, then the serial-interface will automatically increment the index address, by one location, after each slave acknowledge. The master can therefore send data bytes continuously to the slave, until either:

1. The slave fails to provide an acknowledge
2. The master terminates the write communication with a *stop* condition
3. The master sends a *repeated start, (Sr)*.

If the auto increment feature is used, the master does *not* have to send indexes to accompany the data bytes. As data is received by the slave, it is written bit by bit to a serial/parallel register. After each data byte has been received by the slave, an acknowledge is generated. The data is then stored in the internal register, addressed by the current index.

During a read message, the current index is read out from the byte following the device address byte. The next byte read from the slave device, is the contents of the register addressed by the current index. The contents of this register, is then parallel loaded into the serial/parallel register, and clocked out of the device by *SCL*.

At the end of each byte, in both read and write message sequences, an acknowledge is issued by the receiving device. Although VV5409 is always considered to be a slave device, it acts as a transmitter when the bus-master requests a read from the sensor.

At the end of a sequence of incremental reads or writes, the terminal index value in the register will be one *greater* than the last location read from, or written to. A subsequent read will use this index to begin retrieving data from the internal registers.

A message can only be terminated by the bus master, either by issuing a stop condition, a repeated start condition, or by a negative acknowledge, after reading a complete byte during a read operation.

6.5 The Programmers Model

The serial interface programmer's model allows for up to 128, 8-bit registers within the sensor, accessible by the user through the serial-interface. They are grouped, according to function, with each group occupying a 16-byte page of the location address space. There may be up to eight such groups, although this scheme is purely a conceptual feature, and not related to the actual hardware implementation, The primary categories are given below:

- Status Registers (Read Only)
- Setup registers, with bit significant functions
- Exposure parameters, which influence output image brightness
- System functions, and analogue test bit significant registers.

Any internal register which can be written to, can also be read from. There are several read-only registers, which contain device status information, (e.g. design revision details).

Names which end with H or L, denote the most, or least-significant, part of the internal register. Note that unused locations in the H byte, are packed with zeroes.

VISION sensors, which include a 2-wire serial-interface, are designed with a common address space. If a register parameter is unused in a design, but has been allocated an address in the generic design model, the location is referred to as *reserved*. If the user attempts to read from any of these *reserved, or unused* locations, a default byte will be read back. In VV5409 this data is 07_H. A write instruction to a reserved (but unused) location is illegal, and will not be successful, as the device will not allocate an internal register to the data-word contained in the instruction.



A detailed description of each register follows.

Index	Name	Recommended Setting	Register Type	Comments
0	deviceH		RO	Chip identification number including revision indicator
1	deviceL		RO	
2	status0		RO	Current line counter value
3	line_countH		RO	
4	line_countL		RO	
5 - 11	reserved			
12-15	unused			
16	setup0	1000_x000 ₂	R/W	Low-power/sleep modes & Video Timing
17	setup1	01x0_0010 ₂	R/W	Black Calibration
18-19	reserved		R/W	reserved
20	fg_modes		R/W	Frame grabbing modes (FST, LST and QCK)
21	pin_mapping		R/W	FST and QCK mapping modes
22	unused			unused
23	op_format		R/W	Output coding format
24-31	unused			unused
32	fineH		R/W	Fine exposure
33	fineL		R/W	Fine exposure
34	coarseH		R/W	Coarse exposure
35	coarseL		R/W	Coarse exposure
36	gain		R/W	ADC Pre-amp gain setting
37	clk_div		R/W	Clock division
38-111	unused/ reserved			unused/reserved
112	bcal_win		R/W	Black Calibration Window Select
113	bcal0		R/W	Black calibration DAC0
114	bcal1		R/W	Black calibration DAC1
115	reserved			
116	tms0		R/W	Reserved
117	cr0		R/W	Analogue Control Register 0
118	cr1		R/W	Analogue Control Register 1
119	as0		R/W	ADC Setup Register
120	at0		R/W	Analogue Test Register
121	at1	0F _H	R/W	Microphone Amp Setup Register
122-126	unused/ reserved			unused/reserved
127	reserved			Defect SRAM Auto-load Address, where required. Contact VLSI VISION for details

Table 6.2 : VV5409 Serial-Interface Address Map.



6.6 Register descriptions

6.6.1 Status Registers - [0 - 15]

[0-1] - DeviceH and DeviceL

These registers provide read-only information, which identifies the sensor type, coded as a 12-bit number, and a 4-bit mask set revision identifier. The device identification number, for VV5409 is 409 i.e. 0001 1001 0111₂. The initial mask revision identifier is 0 i.e. 0000₂.

Bits	Function	Default	Comment
7:0	Device type identifier	0001 1001 ₂	Most significant 8 bits of the 12 bit code identifying the chip type

Table 6.3 : [0] - DeviceH

Bits	Function	Default	Comment
7:4	Device type identifier	0111 ₂	Least significant 4 bits of the 12 bit code identifying the chip type
3:0	Mask set revision identifier	1010 ₂ or 1101 ₂	

Table 6.4 : [1] - DeviceL

[2] - Status0

Bit	Function	Default	Comment
0	Exposure value update pending	0	Exposure sent, but not yet consumed by the exposure controller
1	Gain value update pending	0	Gain value sent, but not yet consumed by the exposure controller
2	Clock divisor update pending	0	Clock divisor sent, but not yet consumed by the exposure controller
3	Black calibration fail flag	0	If the black calibration has failed, this flag will be raised. It will stay active until the last line of the next successful black calibration
4	Odd/even frame	1	The flag, will toggle-state on alternate frames
5	Video Timing update pending	0	New line, or frame length, value written, but not yet consumed by the video timing controller
6	Debounced Digital Input Flag	0	Debounced, and re-timed version, of DIN pin. If set, cleared at end of status line
7	Auto-load Successful	0	Set if auto-load has been completed successfully, (where used) i.e. E ² PROM present and no serial communications errors have occurred.

Table 6.5 : [2] - Status0

Commercial In Confidence



[3-4] - Line_countH & Line_countL

Register Index	Bits	Function	Default	Comment
3	0:0	Current line count MSB	-	Displays current line count
4	7:0	Current line count LSB	-	

Table 6.6 : Current Line Counter Value.

6.6.2 Setup Registers - [16 - 31]

[16] - Setup0

Bit	Function	Recommended setting	Comment
0	Low Power Mode: Off / On	0 (Default 1)	Powers down the sensor-array. The output data-bus goes to F _H . On power-up, the sensor enters low power mode
1	Sleep Mode: Off / On	0	Puts the sensor-array into reset. The output data-bus goes to F _H
2	Soft Reset Off / On	0	Setting this bit, resets the sensor to its power-up defaults. This bit is also reset
3	Frame/Field Rate select: 25 fps (PAL) / 30 fps (NTSC)	1 (NTSC) 0 (PAL)	Frame/Field Rate select
4	Tri-state output data-bus Outputs Enabled / Tri-state	0	On power-up, the data-bus pads are enabled by default
5	Re-time tri-state update. Off / On	0	Re-time, new tri-state value to a field boundary
7:6	Video Timing Mode Select	As required (Default 00)	00 - CIF Timing Modes 01 - PAL/ NTSC 13.5 MHz Timing Modes 10 - PAL/NTSC 3.2 fsc Timing Modes 11 - unused.

Table 6.7 : Setup0 [16]

Video Mode	setup0 bits [7:6]	setup0 bit [3]	Pixel Clock Divisor	Video Data	Line Length	Field Length	Data Format	Comment
0	00 ₂	0	2	356 x 292	471	304	4-wire	CIF - 25 fps
1		1	2	356 x 292	393	304	4-wire	CIF - 30 fps
2	01 ₂	0	2	356 x 292	432	312/313	4-wire	PAL(13.5 MHz)
3		1	2	306 x 244	429	262/263	4-wire	NTSC (13.5 MHz)

Table 6.8 : Video Timing Modes

Commercial In Confidence



Video Mode	setup0 bits [7:6]	setup0 bit [3]	Pixel Clock Divisor	Video Data	Line Length	Field Length	Data Format	Comment
4	10 ₂	0	2	356 x 292	454	312/313	4-wire	PAL (3.2 fsc)
5		1	2	306 x 244	364	262/263	4-wire	NTSC (3.2 fsc)
6-7	11 ₂	X						Unused

Table 6.8 : Video Timing Modes

[17] - Setup1

Bit	Function	Default	Comment
1:0	Black calibration mode selection	10	Black calibration trigger selection. Default setting decision based on result of monitor test. See table below
2	reserved		
3	Enable immediate clock division update. Off/On	0	Allow manual change, to clock-division, to be applied immediately
4	Enable immediate gain update. Off/On	0	Allow manual change, to gain, to be applied immediately
5	Enable additional black lines (lines 3-8) Off/On	0	If enabled, this bit, will enable the lines immediately following the end-of-frame line 0 - CIF 1 - NTSC and PAL (13.5 MHz and 3.2 fsc)
6	Border rows and columns: Masked or Output	1	These extra pixels/rows are optional
7	Reserved	1	Must be set to 0 for normal pixel readout (see Section 2.2)

Table 6.9 : [17] - Setup1

Black Calibration Mode[1]	Black Calibration Mode[0]	Comment
0	0	No black calibration
0	1	Always trigger black calibration
1	0	Black calibration triggered by a failed monitor test
1	1	Trigger black calibration only if the gain setting changes

Table 6.10 : Black Calibration Mode

If the gain, change trigger option, has been selected, then care should be taken when writing the new gain

Commercial In Confidence



value *if* the **immediate gain update** option has been selected. It is strongly advised that the user should *not* write a new gain value between line 0 (the status line) and line 9 (the last black calibration line). If the gain values are written in a timed manner, then no restriction applies.

[20] - fg_modes

Bit	Function	Default	Comment
1:0	FST/QCK pin modes	0	Selection of FST, QCK pin data
3:2	QCK modes	0	00 - CIF and CCIR-601/656 01 - NTSC and PAL
5:4	LST modes	0	See Table 6.14
7:6	FST modes	0	See Table 6.15

Table 6.11 : [20] - fg_modes

FST/QCK pin mode[1:0]		FST pin	QCK pin
0	0	FST	Slow QCK
0	1	FST	Fast QCK
1	0	Fast QCK	Slow QCK
1	1	Invert of Fast QCK	Fast QCK

Table 6.12 : FST/QCK Pin Selection

QCK mode[1:0]		QCK state
0	0	Off
0	1	Free Running
1	0	Reserved (Must not be selected)
1	1	Valid only during data period off line

Table 6.13 : QCK Modes

LST pin mode[1:0]		LST pin
0	0	Off
0	1	Free Running
1	0	Output for black, video-data, and status lines
1	1	Output only for black, and video-data-lines

Table 6.14 : FST/QCK Pin Selection

FST mode[1:0]		FST state
0	0	Off
0	1	On - qualifies the status line
1	0	FST takes on the function of synchronisation output (SNO). This function has not been verified.

Commercial In Confidence



FST mode[1:0]		FST state
1	1	Enable FST as the De-bounce switch input

Table 6.15 : FST Modes

[21] - pin_mapping

Bit	Function	Default	Comment
0	Map serial-interface register bit values, on to the QCK, and FST pins Off/On	0	
1	Serial-Interface Bit for QCK pin	0	
2	Serial-Interface Bit for FST pin	0	
4:3	Output driver strength select	01	Default setting selects 4mA driver. Recommended setting is 00.
7:5	Unused	0	

Table 6.16 : [21] - pin_mapping

Mapping Enable	FST pin	QCK pin
0	FST	QCK
1	pin_mapping[2]	pin_mapping[1]

Table 6.17 : FST/QCK Pin Selection

oeb_composite	su5[4]	su5[3]	Comments
0	0	0	Drive strength = 2mA
0	0	1	Drive strength = 4mA (Default)
0	1	0	Drive strength = 6mA
0	1	1	unallocated
1	x	x	Outputs are not being driven, therefore driver strength is irrelevant

Table 6.18 : Output driver strength selection



[23] - op_format

Bit	Function	Default	Comment
1:0	Data format select	01	00 - reserved 01 - 4 wire parallel output 10 - 2 wire serial output 11 - 1 wire bit-serial output
2	Embedded SAV/EAV Escape Sequences On / Off	0	0 - Insert Embedded Control Sequences, e.g Start, and End of Active Video, into Output video-data 1 - Pass-through mode. Output video-data equals ADC data
3	Complementary Outputs Off/On	1	If this bit is set, and 4-wire output is NOT selected, then the complement of the output, appears on either 1, or 2 of the output bus lines
4	Enable sample mode Off/On	1	If enabled, the data-bus will continuously output a "96 _H " pattern. With the sensor in this mode, a user can determine the best point at which to sample the data
7:5	Unused		

Table 6.19 : [23] - op_format

6.6.3 Exposure Control Registers [32 - 47]

There is a set of programmable registers, which control the sensitivity of the sensor. The registers are as follows:

1. Fine exposure
2. Coarse exposure time
3. Gain
4. Clock division.

The gain parameter does not affect the integration period, rather it amplifies the video-signal at the output stage of the sensor.

Note: The external exposure (coarse, fine, clock division or gain) values, do not take effect immediately. Data from the serial-interface is read by the exposure algorithm at the start of a video-frame. If the user reads an exposure value from the serial-interface, then the value reported will be the data which has not yet taken effect with the exposure algorithm, because the serial-interface logic stores locally all the data written to the sensor.

Between writing the exposure data, and the point at which the data is consumed by the exposure logic, bit-0 of the status register is set. The gain-value is updated a frame later than the coarse, fine, and clock division parameters, since the gain is applied directly at the video-output stage, and does not require the long set-up time of the coarse, and fine exposure, and the clock division.

To eliminate the possibility of the sensor-array seeing only part of the new exposure and gain setting, if the serial-interface communications extends over a frame boundary, the internal re-timing of exposure and gain data is disabled while writing data to any location in the Exposure page of the serial-interface register map. Thus if the 5 bytes of exposure, and gain data, is sent as an auto-increment sequence, it is not possible for the sensor to consume only part of the new exposure, and gain data.

Some parameters have a limited range of values. If any values are programmed out-with this range, they will be clipped to the maximum value allowed.



Register Index	Bits	Function	Default	Comment
32	0:0	Fine MSB exposure value	0	Maximum mode dependent
33	7:0	Fine LSB exposure value		
34	0:0	Coarse MSB exposure value	302	Maximum mode dependent
35	7:0	Coarse LSB exposure value		
36	3:0	Gain value	0	See Table 6.21
37	1:0	Clock divisor value	0	See Table 6.22

Table 6.20 : Exposure, Clock Rate and Gain Registers

Gain Binary code	Actual signal gain	Gain Binary code	Actual signal gain
0000 ₂	0.500	1000 ₂	0.533
0001 ₂	1.000	1001 ₂	1.143
0010 ₂	0.667	1010 ₂	0.727
0011 ₂	2.000	1011 ₂	2.667
0100 ₂	0.571	1100 ₂	0.615
0101 ₂	1.333	1101 ₂	1.600
0110 ₂	0.800	1110 ₂	0.889
0111 ₂	4.000	1111 ₂	8.000

Table 6.21 : System Analog Video Gain Values

The table above, details **all** the available gain settings. If the sensor has been configured, as it would be following a system reset (using RESETB), in either of the CIF video modes, then not all the gain settings will be available. The lsb of the gain, written through the serial-interface, is replaced with a fixed 1, the top 3-bits are preserved. The subsequent gain values available are 1, 3, 5, 7, 9, 11, 13, and 15.

If any of the other 4 video modes is selected, then the control bit which changes the gain-value as above, is **not** set, and the full 4-bit gain-value, is passed to the CAB unaltered. It is possible to write to the tms register, set this bit, and cause the gain settings to be altered.

Clock Divisor Setting	Pixel Clock Divisor
00 ₂	2
01 ₂	4
10 ₂	8
11 ₂	16

Table 6.22 : Clock Divisor Values

Commercial In Confidence



6.6.4 Serial-Interface Setup Registers [108-111]

Register Index	Bit	Function	Default	Comment
108	0	Re-Initiate Auto-load Sequence	0	Initiate Auto-Load (where used), if bit high, goes from high to low. Auto-load token-bit must be high for auto-load to be triggered
108	1	Auto-load Token No Token / Token	0	Initiate, if low to high transition on bit i.e. auto-load token received. Reset to zero on completion of auto-load i.e. token passed on to next device
	7:3	unused	0	

Table 6.23 : [108] - Serial-Interface Setup Register, sf_setup

Register Index	Bits	Function	Default	Comment
109	7:0	next_dev_addr	-	Serial-Interface Address of next Device in auto-load daisy chain (where used). Default is the sensor's 7-bit serial address plus 4

Table 6.24 : [109] - Serial Address of next Device in Daisy-Chain

6.6.5 System Registers -Addresses [112 - 127]

[112 - 114] - Black Calibration Registers

The sensor is equipped with an automatic function which continually monitors the output black level, and recalibrates, if it has moved out of programmable range. The user is advised to disable the automatic function before attempting to write any of these parameters.

Register Index	Bits	Function	Default	Comment
112	3:0	bcal_window	0	Black Level Monitor/Calibration Window Sizes
113	7:0	bcal0	128	DAC B0 value
114	7:0	bcal1	128	DAC B0 value

Table 6.25 : Black Calibration Registers

Register Index	Bit	Function	Default	Comment
	1:0	bcal_win	0	Black Calibration monitor window size

Table 6.26 : [112] - Black Level Monitor/Calibration Window Sizes

Commercial In Confidence



Register Index	Bit	Function	Default	Comment
	2	Monitor window size set by serial-interface communication Yes/ No	0	Allow the serial-interface to set the Black Calibration monitor window size directly
	3	Narrow Black Calibration target window Yes/ No	0	By default the target window size for the Black Calibration (calibration phase) is set to the widest position
	7:4	used	0	

Table 6.26 : [112] - Black Level Monitor/Calibration Window Sizes

[117 - 118] - Control Registers 0 and 1- CR0 and CR1

Bit	Function	PAL/NTSC value	Default	Comment
0	Enable bit line clamp Off/On	0	0	
1	New PXRDB scheme Off/On	0	0	
2	Inhibit horizontal shift register Off/On	0	0	
3	Enable anti-blooming protection Off/On	1	0	
4	Inhibit OSA fast reset Off/On	0	0	
5	External bit line white reference Off/On	0	0	
6	CDSH Mode New/Old	0	0	By asserting this control bit, the falling edge of CDSH is forced to occur earlier in the line timing
7	VCDSH Voltage 3.0 / 3.9V	1	0	0 - VCDSH = 3.0 V 1 - VCDSH = 3.9 V

Table 6.27 : [117] - Control Register CR0

Bit	Function	PAL/NTSC value	Default	Comment
0	Stand-by Off/On	0	0	Powers down ALL analogue circuitry

Table 6.28 : [118] - Control Register CR1

Commercial In Confidence



Bit	Function	PAL/NTSC value	Default	Comment
1	Power Down - ADC Off/On	0	0	
2	Power Down - ADC Top Reference Off/On	0	0	
3	Power Down - AVO Output Buffer Off/On	0	0	
4	B1 Offset DAC Gain Select Low (x1) / High (x2)	1	0	
5	Inhibit Quiet ADC Signal Off / On	0	0	
7:6	RST/MRST Phase Delay Setting 0° / 90° / 180° / 270°	01	00	00: Phase Delay = 0° (Default) 01: Phase Delay = 90° 10: Phase Delay = 180° 11: Phase Delay = 270°

Table 6.28 : [118] - Control Register CR1

Notes:

- The signal enabling the external ADC functionality, is the logical OR of CR0 [0] bit and the invert of the ADCVDD pin
- The low-power select signal for the analogue circuitry, is the logical OR of PD0 [0] and Setup0 [0].

[119] - ADC Setup Register AS0

Bit	Function	Default	Comment
1:0	ADC Clock Fine Delay Setting 0 ns / 4 ns / 8 ns / 16 ns	00	00: Clock Delay = 0 ns (Default) 01: Clock Delay = 4 ns 10: Clock Delay = 8 ns 11: Clock Delay = 16 ns
3:2	ADC Clock Phase Delay Setting 0° / 90° / 180° / 270°	01	00: Phase Delay = 0° 01: Phase Delay = 90° (Default) 10: Phase Delay = 180° 11: Phase Delay = 270°
5:4	PCK Clock Fine Delay Setting 0 ns / 4 ns / 8 ns / 16 ns	00	00: Clock Delay = 0 ns (Default) 01: Clock Delay = 4 ns 10: Clock Delay = 8 ns 11: Clock Delay = 16 ns
6	ADC Clock Generator Setting Fast / Slow	1	1 - CIF Mode 0 - CCIR-601/656. NTSC, PAL modes
7	Unused		

Table 6.29 : [119] - ADC Setup Register AS0

Commercial In Confidence



[120] - Analogue Test Register AT0

Bit	Function	PAL/NTSC value	Default	Comment
0	Enable test output on AVO Off / On	0	0	Internal test mode
1	Monitor bitline voltage or input to the Column Sample Hold Vx / V1	0	0	Internal test mode
2	Monitor column 354 or 355 354 / 355	0	0	Internal test mode
3	Spare	0	0	
4	OSA Pre-Charge Timing LRPC / (LRPC + PRPC)	1	0	0 - Line Rate Pre-Charge (LRPC) 1 - LRPC + Pix Rate Precharge (PRPC)
5	OSA Pixel Rate Pre-Charge Hi Duration 4 ns / 8 ns	0	0	0 - PRPC Width = 4 ns 1 - PRPC Width = 8 ns
6	OSA Pre-Charge Voltage VDD / VDD - 0.5 V	0	0	0 - Pre-Charge Voltage = VDD 1 - Pre-Charge Voltage = VDD - 0.5 V
7	VRT Voltage 2.5 V / 2.75 V	0	0	0 - VRT = 2.5 V 1 - VRT = 2.75 V

Table 6.30 : [120] - Analogue Test Register AT0

[121] - Microphone Amplifier Setup Register AT1

Bit	Function	Default	Comment
3:0	Microphone Amplifier Gain	0	See Table 6.32
4	Digitise Microphone Amplifier Output Off / On	0	If this bit is selected, the ADC will convert the output from the microphone amplifier
5	Pad to supply analogue input to Microphone amplifier On / Off	0	If this bit is 1, the pad will supply a signal holdpix which will inhibit the ADC operating. If this bit is 0, the holdpix input is connected to the input of the microphone amplifier
6	Power down microphone amplifier Off / On	0	



Bit	Function	Default	Comment
7	Microphone Amplifier Digitisation Mode EAV / Always	0	Digitise the Microphone output, either only during the end of active video embedded escape sequence, or always

Table 6.31 : [121] - Microphone Amplifier Setup Register AT1

The register values shown in Table 6.32 correspond to actual gain values, where Actual gain = V_{out}/V_{in} . Register: at1 on VV5409. Default is 15.

Gain register	0	1	2	3	4	5	6	7	8	9	10	11	12	13	14	15
Actual gain	1	2	4	8	2	4	8	16	4	8	16	32	8	16	32	64

Table 6.32 : Audio Gain register Settings

6.7 Types of serial interface messages

This section gives guidelines on the basic operations of reading data from, and writing data to, the serial-interface.

The serial-interface supports variable length messages. A message may contain no data-bytes, one data-byte, or many data-bytes. This data, can be written to, or read from common, or different locations within the sensor. The range of instructions available are detailed below.

- Write no data-byte, only sets the index for a subsequent read message
- Single location, multiple data write, or read for monitoring (real time control)
- Multiple location, multiple data read, or write, for fast information transfers.

Examples of these operations are given below. A full description of the internal registers, is given in the previous section. For all examples, the slave address used is 32₁₀ for writing, and 33₁₀ for reading. The write address includes the read/write bit (the lsb), set to zero while this bit is set in the read address.

6.7.1 Single location, single data write

When a random value is written to the sensor, the message will look like this:



Figure 6.4 : Single location, single write

In this example, the *fineH* exposure register (index = 32₁₀), is set to 85₁₀. The r/w-bit is set to zero for writing, and the *inc* bit (msbit of the index byte), is set to zero, to disable automatic incrementation of the index after writing the value. The address index is preserved and may be used by a subsequent read. The write message is terminated with a stop condition from the master.

6.7.2 Single location, single data read

A read message always contains the index used to get the first byte.

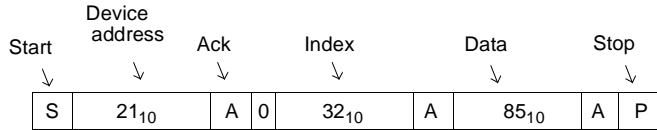

Figure 6.5 : Single location, single read

This example assumes that a write message has already taken place, and the residual index value is 32₁₀. A value of 85₁₀ is read from the *fineH* exposure register. Note that the read message is terminated with a negative acknowledge (\bar{A}) from the master; it is not guaranteed that the master will be able to issue a stop condition, at any other time during a read message. This is because, if the data sent by the slave is all zeros, the *SDA* line cannot rise, which is part of the stop condition.

6.7.3 No data write, followed by same location read

When a location is to be read, but the value of the stored index is not known, a write message with no data byte must be written first, specifying the index. The read message then completes the message sequence. To avoid relinquishing the serial-bus to another master, a repeated start condition is asserted between the write, and read messages. In this example, the *gain* value (index = 36₁₀) is read as 15₁₀.

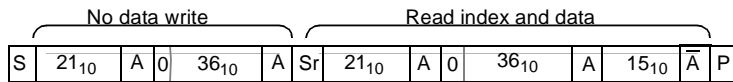

Figure 6.6 : No data write followed by same location read

As mentioned in the previous example, the read message is terminated with a negative acknowledge (\bar{A}) from the master.

6.7.4 Same location, multiple data write

It may be desirable to write a succession of data to a common location. This is useful when the status of a bit, (e.g. requesting a new black calibration), must be toggled.

The message sequence indexes *setup1* register. If bit 1 is toggled low, high low this will initiate a fresh black calibration. This is achieved by writing three consecutive data bytes to the sensor. There is no requirement to re-send the register index before each data byte.

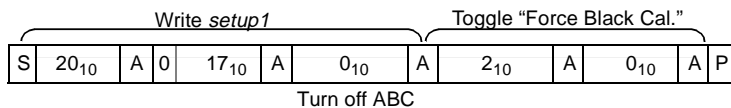

Figure 6.7 : Same location multiple data write

6.7.5 Same location, multiple data read

When an exposure related value (*fineH*, *fineL*, *coarseH*, *coarseL*, *gain*, or *clk_div*) is written, it takes effect on the output at the beginning of the next video frame, (remember that the application of the *gain* value is a frame later than the other exposure parameters). To signal the consumption of the written value, a flag is set when any of the exposure, or gain registers, are written, and is reset at the start of the next frame. This flag appears in *status0* register, and may be monitored by the bus master. To speed up reading from this location, the sensor will repeatedly transmit the current value of the register, as long as the master acknowledges each byte read.

In the next example, a *fineH* exposure value of 0 is written, the status register is addressed (no data byte), and constantly read until the master terminates the read message.

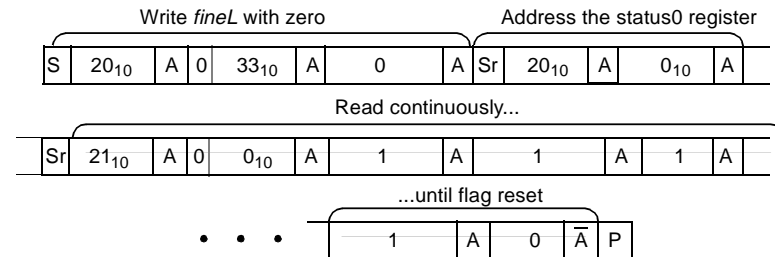

Figure 6.8 : Same location, multiple data read

6.7.6 Multiple location write

If the automatic increment bit is set, (msb of the index byte), it is possible to write data bytes to consecutive, adjacent internal registers, without having to send explicit indexes prior to sending each data byte. An auto-increment write to the black calibration DAC registers, with their default values is shown in the following example.

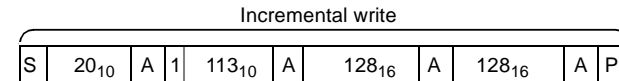

Figure 6.9 : Multiple location write

6.7.7 Multiple location read

In the same manner, multiple locations can be read with a single read message. In this example the index is written first, to ensure the exposure related registers are addressed, and then all six are read.

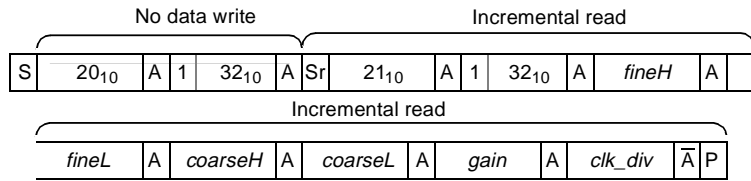

Figure 6.10 : Multiple location read

Note that a stop condition is not required after the negative acknowledge from the master.



6.8 Serial-Interface Timing

Parameter	Symbol	Min.	Max.	Unit
SCL clock frequency	fscl	0	100	kHz
Bus free time between a stop and a start	tbuf	TBD	-	us
Hold time for a repeated start	thd;sta	80	-	nS
LOW period of SCL	tlow	320	-	nS
HIGH period of SCL	thigh	160	-	nS
Set-up time for a repeated start	tsu;sta	80	-	nS
Data hold time	thd;dat	0	-	us
Data Set-up time	tsu;dat	0	-	ns
Rise time of SCL, SDA (from $V_{IL} = 0.2V_{DD} - V_{IH} = 0.8V_{DD}$)	tr	-	300 (Note 1)	ns
Fall time of SCL, SDA (from $V_H = 2.4v - V_L = 0.5v$)	tf	-	300 (Note 1)	ns
Set-up time for a stop	tsu;sto	80	-	nS
Capacitive load of each bus line (SCL, SDA)	Cb	-	200	pF

Table 6.33 : Serial Interface Timing Characteristics

Notes on Table 6.33:

(1) With 200pF capacitive load. It is recommended that pull-up resistors of 2.2k are fitted to both SDA and SCL lines (see Section 13.).

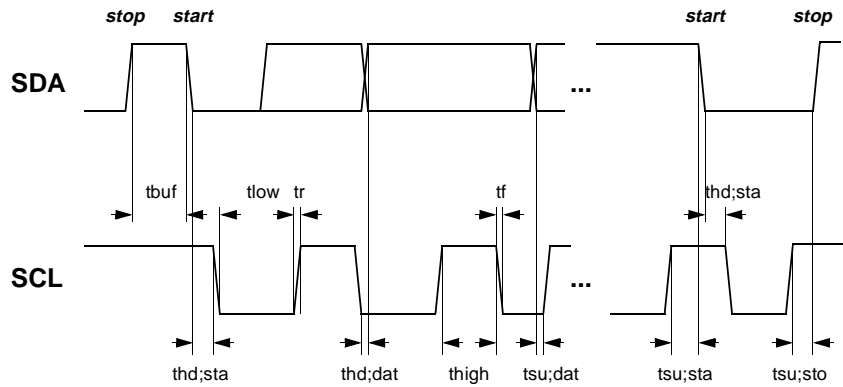

All values referred to the minimum input level (high) = 3.5V, and maximum input level (low) = 1.5V

Figure 6.11 : Serial Interface Timing Characteristics

7. Clock Signal

VV5409 system clock is supplied from an external clock source, directly driving the CLKI pin. This pin has an internal Schmitt buffer. There is no support for a crystal oscillator.

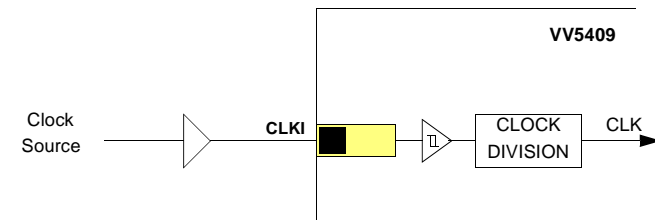

Figure 7.1 : External Clock Source

If the clock is generated for the video sensor by a host controller, it must be active during serial-interface communications for at least 16 clock cycles, before the serial communications start bit, and at least 16 cycles after the serial communications stop bit.

The synchronisation input, SIN, synchronises the clock divider logic in addition to the main clock generation, and the video timing control block.

For greater flexibility the pixel frequency (for 4 wire output format) can be divided by 2, 4, 8, or 16. The pixel clock frequency is a further factor of 2 down for 2-wire, or a factor of 4 for bit-serial mode.

The clock signal must be a square wave with a 50% ($\pm 10\%$) mark:space ratio. Table 7.1 specifies the maximum pixel clock frequencies for the module. Table 7.2 specifies the relationship between the input clock, CLKI, and the pixel clock frequency for the different settings of the sensor's internal clock divider.

This translates into a maximum input clock frequency of 14.31818 MHz if a pixel clock divisor of 2 is used (the default - Table 7.2).

	MHz
Maximum Pixel Rate	7.15909

Table 7.1 : Maximum Pixel Clock Rate

Clock Divisor Setting	Pixel Clock Divisor
00 ₂	2
01 ₂	4
10 ₂	8
11 ₂	16

Table 7.2 : Clock Divisor Values

8. Synchronising Multiple Cameras

A rising edge on the SIN pin re-synchronises the sensors internal video timing logic and clock generators to 6 pixels before the end of the start of frame control sequence in line 0. By supplying a rising edge to SIN once per frame, 2 cameras can be synchronised together. Via the serial interface the function of the FST pin can be modified to generate the required synchronisation output signal (SNO). Synchronising cameras is done by setting one camera up as the master and feeding its SNO signal to the SIN input of the other cameras.
 Note: The correct functionality of the SNO output has not been verified.

The internal logic is designed such that if the rising edge of SIN occurs in the correct place, 6 pixels (for the default pixel counter reset value) before the end of the start of frame control sequence, the sensor's operation is unaffected. Otherwise the video timing and clock generation will be reset. The following frame should be treated as corrupt.

SIN is sampled internally by the system clock, CKI. If all cameras are supplied with the same clock signal then the reset generated by SIN will synchronise all the cameras to the same point in time. However, if the cameras being synchronised are running at the same frequency but each camera has its own crystal, then there could be up to one system clock period of skew between the cameras. This skew will vary over time due to the slight mismatches between frequencies of the different crystals.

Frame/Field Format:

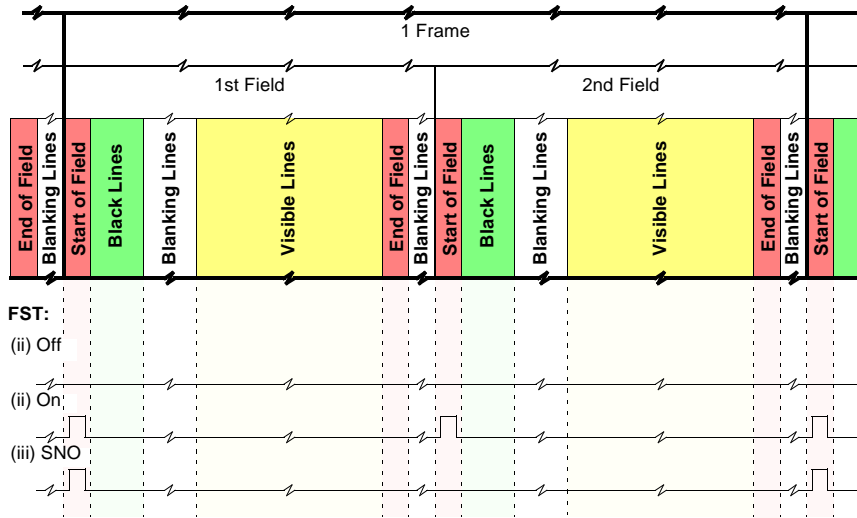

Figure 8.1 : FST and SNO Signals - Frame / Field Level Timing

Start of Field Line Format:

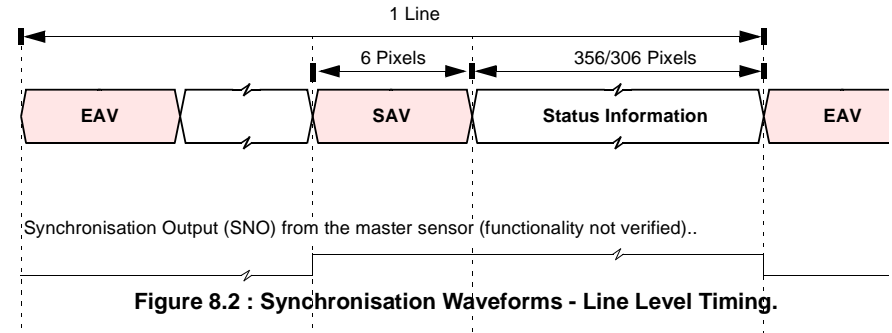

Figure 8.2 : Synchronisation Waveforms - Line Level Timing.

9. Other Features

9.1 Microphone Amplifier

The internal Microphone amplifier, comprises 3 separate amplifiers. The first 2 in the chain have programmable gain values (x 1, x 2, x 4 and x 8). The third amplifier is configured as a voltage follower, and drives the AOUT pin. Pin AIN is the input to the first amplifier in the chain.

The gain of each of the first two amplifiers, is independently controllable through the serial-interface register *at1*. There are 7 possible overall system gains: x 1, x 2, x 4, x 8, x 16, x 32, and x 64.

The input, and output voltage ranges, should lie within the ADC_{top} and ADC_{bot} voltages. The mid-point of these two references is used as the virtual ground for the first two amplifiers.

The output amplifier, can drive a 2v peak-peak load (1.3v DC offset) with 1k ohm minimum impedance. The compensation capacitor for the output amplifier is external. By varying the AC-coupling capacitor on the input, and the compensation capacitor on the output, the frequency response of the amplifier can be modified.

Input, and output voltage ranges are from the voltage reference ADC_{bot} to the ADC_{top} voltage reference.

The Microphone amplifier setup register, also allows the amplifiers to be powered-down, and there is an option to multiplex internally the output of the final amplifier during the embedded "End-of-Line" sequence, on to the input of the 8-bit ADC used to digitise pixel-data. The digitised data for 2 consecutive samples, appears as the 2 supplementary bytes in the 6-byte end of line embedded escape sequence. Thus the video-data stream contains 2 consecutive samples of the output of the Microphone amplifier once per line.

Bit	Function	Default	Comment
1:0	2-bit gain value for 1st gain stage, a0[1:0]	00	00: 1st Stage Gain = x 1 01: 1st Stage Gain = x 2 10: 1st Stage Gain = x 4 11: 1st Stage Gain = x 8
3:2	2-bit gain value for 2nd gain stage, a1[1:0]	00	00: 2nd Stage Gain = x 1 01: 2nd Stage Gain = x 2 10: 2nd Stage Gain = x 4 11: 2nd Stage Gain = x 8
4	Digitise Microphone Amplifier Output Off / On	0	If this bit is selected, the ADC will convert the output from the microphone amplifier
5	Pad to supply analogue input to Microphone amplifier Off / On	1	If this bit is reset, the pad will supply a signal holdpix which will inhibit the ADC operating
6	Power down microphone amplifier Off / On	0	
7	Microphone Amplifier Digitisation Mode EAV / Always	0	Digitise the Microphone output, either only during the end of active video embedded escape sequence, or always

Table 9.1 : [121] - Microphone Amplifier Setup Register AT1

The register values shown in Table 9.2 correspond to actual gain values. Register: at1 on VV5409. Default

is 15.

Gain register	0	1	2	3	4	5	6	7	8	9	10	11	12	13	14	15
Actual gain	1	2	4	8	2	4	8	16	4	8	16	32	8	16	32	64

Table 9.2 : Audio Gain register Settings

9.2 Debounced Switch Input

VV5409 provides a special debounced digital input pin, FST/DIN, for switches. When FST/DIN is enabled as a debounced switch input, a low on the DIN sets a set/reset latch. The value of this latch, is part of status register *status0*, and thus can be observed through the serial-interface register data contained in the start-of-field line. At the end of a start-of-field line, the latch is reset.

This input is primarily intended for a user to "mark" the required frame, by pressing a button perhaps on a remote camera head.

This feature can be enabled by bits 6 and 7 of the *fg_modes* register (see Table 6.11).

9.3 Serial-Interface Programmable Pins

The FST and QCK can be re-configured to follow the values of bits 1 and 2 in the serial-interface register *pin_mapping*. This is to allow remote control of an electro-mechanical system, for example two different zoom settings, in a remote camera head through the serial-interface.

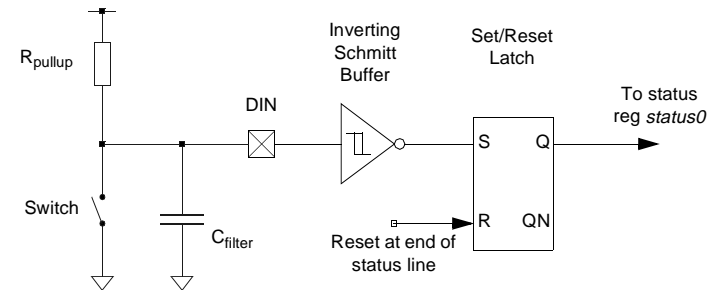

Figure 9.1 : Debounced Switch Input



10. Detailed specifications

Image Format	306 x 244 pixels (NTSC) 356 x 292 pixels (PAL)
Pixel Size	9.0x 8.25µm
Technology	0.6µm 2 level metal CMOS
Array Format	CIF
Exposure control	25000:1
Sensor signal / Noise ratio	TBD
Supply Voltage	5.0v DC +/-5%
Package type	48LCC (sampling) 48BGA (production)
Operating Temp. range	0°C - 40°C
Logic 0 input	0.2 x Vdd Max
Logic 1 input	0.8 x Vdd Min
Serial interface frequency range	0-100kHz

Table 10.1 : VV5409 Specifications

Current Consumption	TBD
---------------------	-----

Table 10.2 : VV5409 Specifications

Audio pre-amp output rating	2v peak-peak 1.3v DC offset
Audio pre-amp output Min. Impedance	1k ohms
Audio pre-amp input	AC coupled 2v peak-peak max

Table 10.3 : VV5409 Audio Pre-amplifier

Commercial In Confidence



11. Pinouts and pin descriptions

11.1 Sensor pin list

Pin No. (48LCC)	Pin No. (48BGA)	Name	Type	Description
POWER SUPPLIES				
1	A4	AVCC	PWR	Power
48	C4	AGND	GND	Ground
43	B2	DVDD	PWR	Digital Power
44	C3	DVSS/Dsub	GND	Digital Ground
6	C5	AVDD	PWR	Output stage power
5	A6	AVSS	GND	Output stage ground
7	A7	VVDD	PWR	Analogue output buffer power
9	B7	VVSS	GND	Analogue output buffer ground
14	D5	ADCVD	PWR	ADC power
10	C6	ADCVSS	GND	ADC ground
19	G7	VDD1	PWR	Power
30	F3	VDD2	PWR	Power
36	E2	VDD3	PWR	Power
20	F6	VSS1	GND	Ground
29	G2	VSS2	GND	Ground
37	D1	VSS3	GND	Ground
-	D4	Die Paddle	GND	Die paddle on BGA package only. Connect to AGND.
ANALOGUE SIGNALS				
45	A2	VBLOOM	OA	Anti-blooming pixel reset voltage
46	B3	VBLTW	OA	Bitline test white level reference
47	A3	VBG	OA	Internally generated bandgap reference voltage 1.22V
2	B4	VCM/ VREF2V5	OA	Common-mode input for OSA and Internally generated 2.5 V reference voltage
3	A5	VRT	IA	Pixel reset voltage
4	B5	VCDSH	IA	Correlated Double Sampling reference
8	B6	DNC	-	Reserved

Commercial In Confidence

Pin No. (48LCC)	Pin No. (48BGA)	Name	Type	Description
11	C7	ADCbot	IA	Bottom voltage reference for ADC
12	D6	AIN	IA	Analogue input for Audio pre-amp
13	D7	ADCTop/ TopRef	OA	Internally generated top voltage reference for ADC
15	E7	AOUT	OA	Analogue output from Audio pre-Amp
DIGITAL CONTROL SIGNALS				
16	E6	SIN	ID↓	Reserved
17	F7	RESETB	ID↑	System Reset. Active Low.
SERIAL-INTERFACE				
42	C2	SCL	ID↑	Serial bus clock (input only)
41	B1	SDA	BI↑	Serial bus data (bidirectional, open drain)
DIGITAL VIDEO INTERFACE				
39	C1	D[3]	ODT	Tri-stateable 4-wire output data-bus. D[3] is the most significant bit
38	D2	D[2]		
35	E1	D[1]		
34	E3	D[0]		
33	F1	QCK	ODT	Tri-stateable data qualification clock
40	D3	FST/DIN	ODT	Tri-stateable Frame start signal/Debounced switch input
32	F2	LST	ODT	Line start signal
SYSTEM CLOCKS				
31	G1	CLKI	ID	Oscillator input
NOT CONNECTED (48LCC)				
18	-	NC		Not connected
21-28	-	NC		Not connected
NOT CONNECTED (48BGA)				
-	E4, E5	NC		Not connected
-	F4, F5	NC		Not connected
-	G3, G4, G5, G6	NC		Not connected

Commercial In Confidence

Table 11.1 : Pin descriptions for VV5409

Key			
A	Analogue Input	D	Digital Input
OA	Analogue Output	ID↑	Digital input with internal pull-up
BI	Bidirectional	ID↓	Digital input with internal pull-down
BI↑	Bidirectional with internal pull-up	OD	Digital Output
BI↓	Bidirectional with internal pull-down	ODT	Tri-stateable Digital Output
DNC	Non-user pin: Do not connect	NC	Not connected

Table 11.2 : Key to Pin descriptions for VV5409

11.2 48BGA pinout

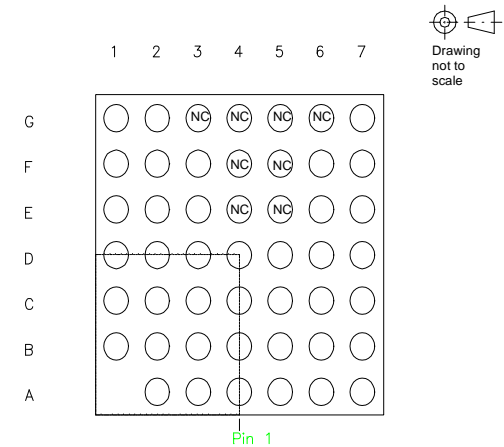

Figure 11.1 : 48BGA pinout (viewed from die side)

Commercial In Confidence

11.3 48LCC Pinout

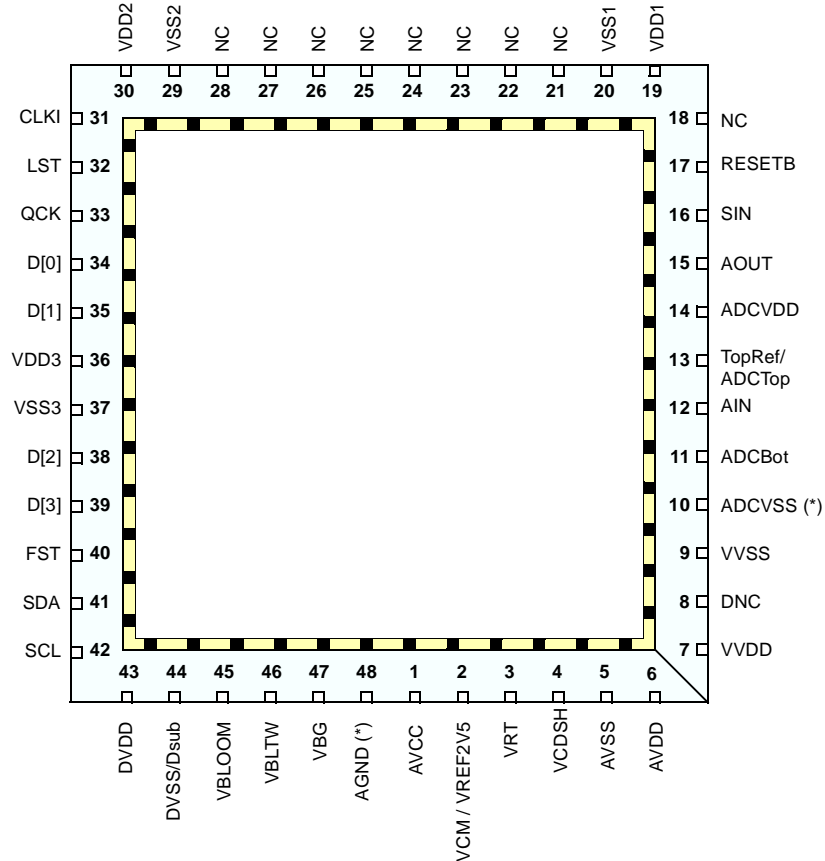

Figure 11.2 : VV5409 Pinout in 48 LCC Package

Notes on Figure 11.2:

1. Diagram viewed from above
2. (*) - Paddle Connections
3. NC = Not Connected
4. DNC = Do not connect (Non-user pin)

12. Package dimensions

12.1 48BGA (400G)

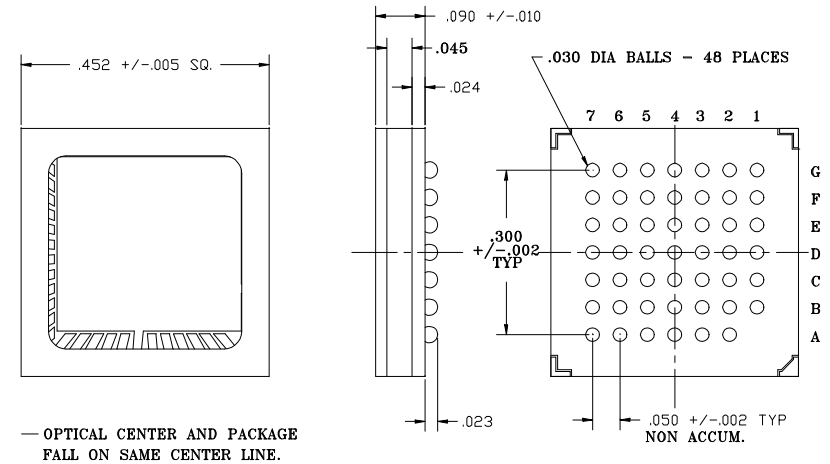

Figure 12.1 : BGA Package dimensions

Additional notes:

1. All dimensions given in inches.
2. The height of the sensor photoplane (upper die surface) above the bottom of the BGA package = 1.053mm +/- 0.0254mm
3. After reflow, the separation between the PCB surface and the bottom of the BGA package will be 0.4826mm +/- 0.0254mm (when recommended footprint is used, as per the example detailed in the Applications Note: 'Single Standard (NTSC or PAL) CMOS Camera Design Guidelines using the VV6407 sensor and AP1 co-processor').
4. The optical centre of the die is located at the centre of the package.

12.2 48LCC

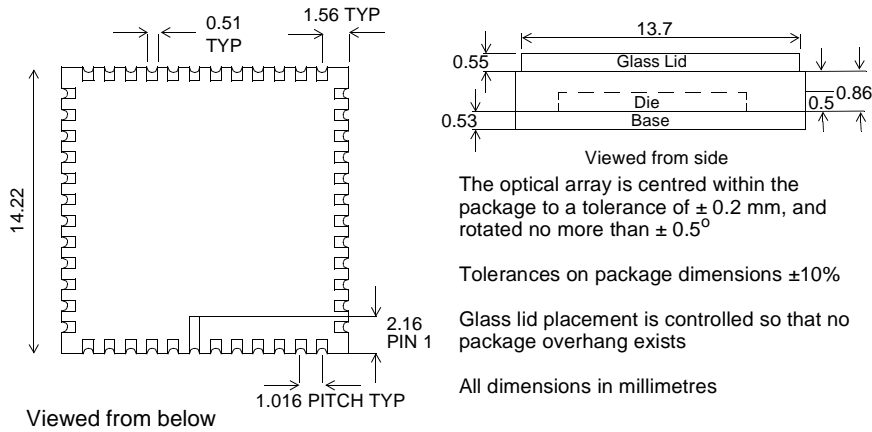

Figure 12.2 : 48LCC package dimensions and optical centering

13. Suggested VV5409 support circuit

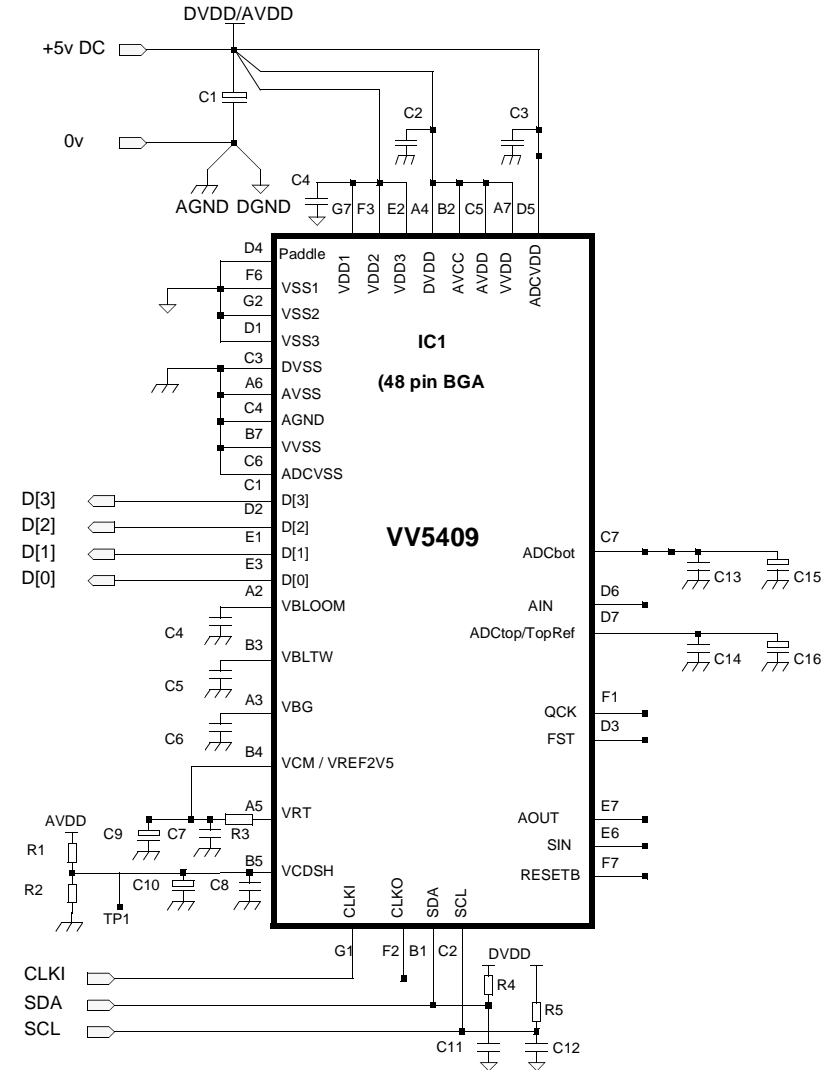

Figure 13.1 : Suggested schematic for VV5409



Component	Part No. / Provisional Value	Rating / Notes
IC1	VV5409	CMOS Image Sensor chip (48 pin LCC/48BGA)
C1	33.0 μ F	6V tant.
C2-C3, C4-C6, C7-C8	0.1 μ F	
C9-C10	10.0 μ F	6V tant.
C11-C12	220pF(*)	For 3m cable length
C13-C14	0.1 μ F	
C15	4.7 μ F	6V tant
C16	10.0 μ F	6V tant
	TDB	
R1-R2	Voltage divider such that TP1 = 3.2v	Suitable values: R1 = 22k, R2 not fitted
R3	33 Ω	
R4-R5	2k2 Ω (*)	For 3m cable length

Table 13.1 : PCB Component List

Notes:

1. Use surface mount components throughout.
2. Keep nodes Supply and Ground pins low impedance and independent.
3. Keep circuit components close to chip pins (especially de-coupling capacitors).
4. EMC precautions will be required on D[3:0] if driving a longer cable.



14. Evaluation kits (EVK's)

It is highly recommended that an Evaluation Kit (EVK) is used for initial evaluation and design-in of the VV5409. A VV5409 evaluation kit is currently under development. Please contact VLSI VISION for details.

15. Ordering details

Part number	Description
VV5409B001	BGA packaged CMOS Sensor
VV5409C001	LCC packaged CMOS Sensor
	Evaluation Kit for VV5409 (contact VLSI VISION for further details)

Table 15.1 : VV5409 Ordering details



VLSI VISION LIMITED

www.vvl.co.uk Email: info@vvl.co.uk

Aviation House, 31 Pinkhill,
Edinburgh EH12 7BF UK
Tel:+44 (0) 131 539 7111
Fax:+44 (0)131 539 7141

1190 Saratoga Ave. Suite 180,
San Jose CA 95129 USA
Tel: +1 408 556 1550
Fax: +1 408 556 1564

571 West Lake Avenue, Suite 12,
Bay Head NJ 08742 USA
Tel: +1 732 701 1101
Fax: +1 732 701 1102

VLSI VISION Ltd. reserves the right to make changes to its products and specifications at any time. Information furnished by VISION is believed to be accurate, but no responsibility is assumed by VISION for the use of said information, nor any infringements of patents or of any other third party rights which may result from said use. No license is granted by implication or otherwise under any patent or patent rights of any VISION group company.

© Copyright 1998, VLSI VISION

Distributor/Agent: