

SERIES: VSK-S15-T | **DESCRIPTION:** AC-DC POWER SUPPLY

FEATURES

- up to 15 W continuous output
- encapsulated compact case
- output short circuit protection
- over current protection
- thermal protection
- CE, UL safety approval
- regulated output
- universal input (85~264 Vac)
- efficiency up to 85%

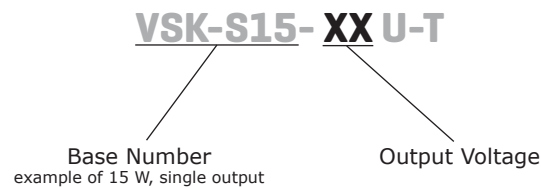

| MODEL | output voltage | output current | output power | ripple and noise | efficiency |
|----------------|----------------|----------------|--------------|------------------|------------|
| | (Vdc) | max (A) | max (W) | max (mVp-p) | max (%) |
| VSK-S15-3R3U-T | 3.3 | 3 | 9.9 | 50 | 73 |
| VSK-S15-5U-T | 5 | 2.8 | 14 | 50 | 76 |
| VSK-S15-9U-T | 9 | 1.6 | 14.4 | 50 | 78 |
| VSK-S15-12U-T | 12 | 1.25 | 15 | 50 | 80 |
| VSK-S15-15U-T | 15 | 1 | 15 | 50 | 80 |
| VSK-S15-24U-T | 24 | 0.625 | 15 | 50 | 84 |
| VSK-S15-48U-T | 48 | 0.320 | 15.36 | 50 | 85 |

PART NUMBER KEY

INPUT

| parameter | conditions/description | min | typ | max | units |
|---------------------------------|-----------------------------|-----------|------------|------------|------------|
| voltage | | 85 120 | | 264 370 | Vac Vdc |
| frequency | | 47 | | 63 | Hz |
| input current | at 110 Vac at 230 Vac | | 250 140 | | mA mA |
| inrush current | at 110 Vac at 230 Vac | | 10 20 | | A A |
| recommended external input fuse | 2 A / 250 V, slow-blow type | | | | |

OUTPUT

| parameter | conditions/description | min | typ | max | units |
|-------------------------|------------------------|-----|------|-----|-------|
| voltage set accuracy | | | ±2 | | % |
| line regulation | | | ±0.5 | | % |
| load regulation | at 10~100% load | | ±1 | | % |
| minimum load | | 0 | | | % |
| hold-up time | at 230 Vac | | 80 | | ms |
| temperature coefficient | | | 0.02 | | %/°C |
| switching frequency | | | 65 | | kHz |

PROTECTIONS

| parameter | conditions/description | min | typ | max | units |
|--------------------------|---------------------------|-----|-----|-----|-------|
| over voltage protection | 3.3 and 5 V models | | | 7.5 | Vdc |
| | 9 V model | | | 12 | Vdc |
| | 12 and 15 V models | | | 20 | Vdc |
| | 24 V model | | | 30 | Vdc |
| | 48 V model | | | 60 | Vdc |
| overload protection | | 110 | | | % |
| short circuit protection | shutdown and auto restart | | | | |

SAFETY & COMPLIANCE

| parameter | conditions/description | min | typ | max | units |
|-------------------|---|---------|-----|-------|-------|
| isolation voltage | for 1 minute | | | 3,000 | Vac |
| safety approvals | CISPR22/EN 60950-1, IEC 60950-1, UL 60950-1 | | | | |
| safety class | Class I | | | | |
| EMI/EMC | EN 55022 class B, IEC/EN 61000-4-(2, 3, 4, 5) | | | | |
| leakage current | at 230 Vac, 50 Hz | | | 0.3 | mA |
| MTBF | at 25°C, max. load | 300,000 | | | hours |
| RoHS compliant | yes | | | | |

ENVIRONMENTAL

| parameter | conditions/description | min | typ | max | units |
|-----------------------|------------------------|-----|-----|-----|-------|
| operating temperature | | -40 | | 70 | °C |
| storage temperature | | -40 | | 105 | °C |
| case temperature | | | | 90 | °C |
| humidity | non-condensing | | | 85 | % |

DERATING CURVES

1. output power vs. ambient temperature

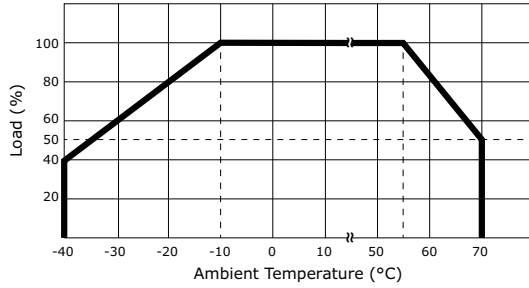

2. output power vs. input voltage

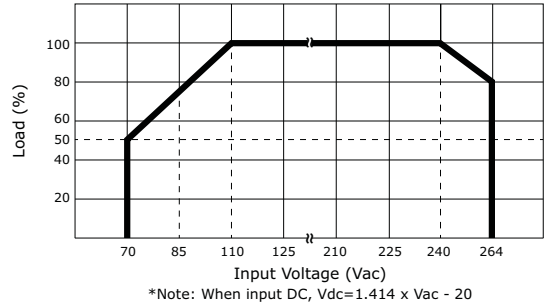

MECHANICAL

| parameter | conditions/description | min | typ | max | units |
|------------|--|-----|-----|-----|-------|
| dimensions | 3.783 x 2.126 x 1.22 (96.1 x 54 x 31 mm) | | | | inch |
| weight | | | 130 | | g |

MECHANICAL DRAWING

units: mm [inches]
tolerance: ±0.50 [±0.020]

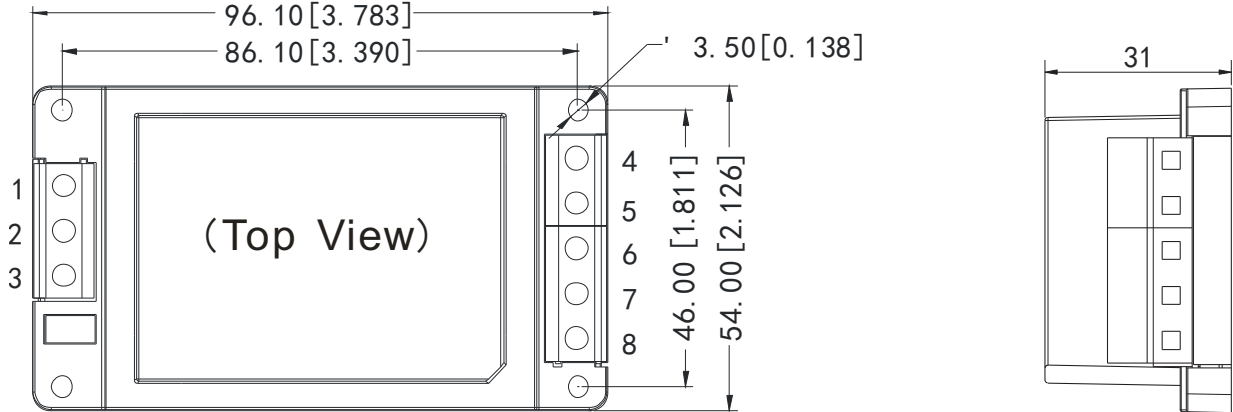

| PIN CONNECTIONS | |
|-----------------|----------|
| PIN | FUNCTION |
| 1 | GND |
| 2 | AC[N] |
| 3 | AC[L] |
| 4 | -Vo |
| 5 | NC |
| 6 | NC |
| 7 | NC |
| 8 | +Vo |

TYPICAL APPLICATION CIRCUIT

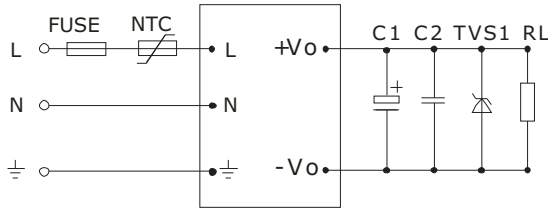

| EXTERNAL CAPACITORS TYPICAL VALUE (Unit: μF) | |
|---|-----|
| MODEL | C1 |
| VSK-S15-3R3U-T | 680 |
| VSK-S15-5U-T | 680 |
| VSK-S15-9U-T | 470 |
| VSK-S15-12U-T | 220 |
| VSK-S15-15U-T | 220 |
| VSK-S15-24U-T | 68 |
| VSK-S15-48U-T | 33 |

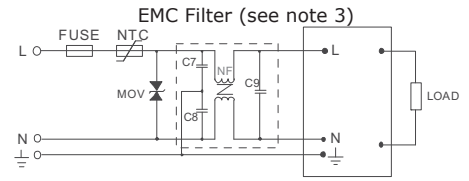

- Notes:
- Output filtering capacitors C1, C2 and C3 are electrolytic capacitors, It is recommended to use high frequency and low impedance electrolytic capacitors. For capacitance and current of capacitor please refer to manufacture's datasheet. Voltage derating of capacitor should be 80% or above. TVS is recommended component to protect post-circuits (if converter fails).
 - 0.1 μF is recommended for C1.
 - If a higher requirement to EMC performance is required it is recommended to add an "EMC filter" at the input end, recommended parameter are as follows:
 MOV: Varistor is used to protect the device under surge.
 C7, C8: Y capacitor, recommended parameter 2200pF/400V;
 C9: X capacitor, recommended parameter 0.1 μF /275V;
 NF: common model choke, recommended inductance is about 10mH-30mH.

TYPICAL EFFICIENCY CURVES

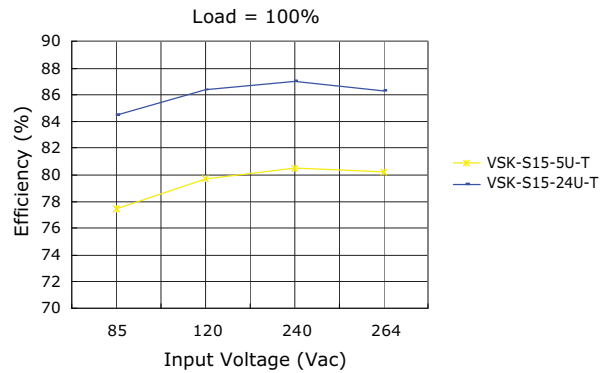
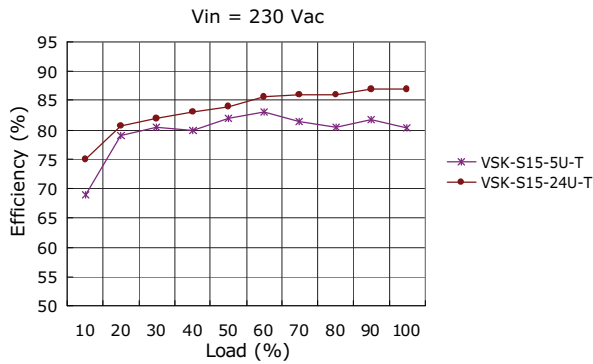

PARALLEL LINES

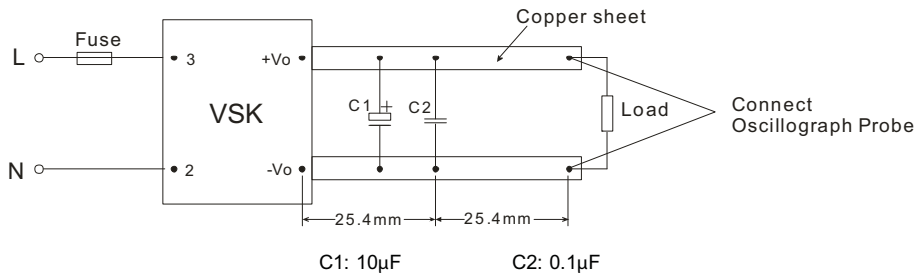

REVISION HISTORY

| rev. | description | date |
|------|-----------------|------------|
| 1.0 | initial release | 09/06/2012 |

The revision history provided is for informational purposes only and is believed to be accurate.



Headquarters
20050 SW 112th Ave.
Tualatin, OR 97062
800.275.4899

Fax 503.612.2383
cui.com
techsupport@cui.com

CUI offers a two (2) year limited warranty. Complete warranty information is listed on our website.

CUI reserves the right to make changes to the product at any time without notice. Information provided by CUI is believed to be accurate and reliable. However, no responsibility is assumed by CUI for its use, nor for any infringements of patents or other rights of third parties which may result from its use.

CUI products are not authorized or warranted for use as critical components in equipment that requires an extremely high level of reliability. A critical component is any component of a life support device or system whose failure to perform can be reasonably expected to cause the failure of the life support device or system, or to affect its safety or effectiveness.