

Insulated Gate Bipolar Transistor Ultralow $V_{CE(on)}$, 250 A



SOT-227

PRIMARY CHARACTERISTICS	
V_{CES}	600 V
$V_{CE(on)}$ (typical) at 200 A, 25 °C	1.33 V
I_C at $T_C = 90$ °C	250 A
Speed	DC to 1 kHz
Package	SOT-227
Circuit configuration	Single switch no diode

FEATURES

- Standard: optimized for minimum saturation voltage and low speed
- Lowest conduction losses available
- Fully isolated package (2500 V_{AC})
- Very low internal inductance (5 nH typical)
- Industry standard outline
- Designed and qualified for industrial level
- UL approved file E78996
- Material categorization: for definitions of compliance please see www.vishay.com/doc?99912

**RoHS
COMPLIANT**
BENEFITS

- Designed for increased operating efficiency in power conversion: UPS, SMPS, TIG welding, induction heating
- Easy to assemble and parallel
- Direct mounting to heatsink
- Plug-in compatible with other SOT-227 packages

ABSOLUTE MAXIMUM RATINGS				
PARAMETER	SYMBOL	TEST CONDITIONS	MAX.	UNITS
Collector to emitter voltage	V_{CES}		600	V
Continuous collector current	I_C	$T_C = 25$ °C	400	A
		$T_C = 90$ °C	250	
Pulsed collector current	I_{CM}	Repetitive rating; $V_{GE} = 20$ V, pulse width limited by maximum junction temperature	400	
Clamped Inductive load current	I_{LM}	$V_{CC} = 80$ % (V_{CES}), $V_{GE} = 20$ V, $L = 10$ μ H, $R_g = 2.0$ Ω	400	
Gate to emitter voltage	V_{GE}		± 20	V
Power dissipation	P_D	$T_C = 25$ °C	961	W
		$T_C = 90$ °C	462	
Isolation voltage	V_{ISOL}	Any terminal to case, $t = 1$ min	2500	V

THERMAL AND MECHANICAL SPECIFICATIONS						
PARAMETER	SYMBOL	TEST CONDITIONS	MIN.	TYP.	MAX.	UNITS
Junction and storage temperature range	T_J, T_{Stg}		-40	-	150	°C
Thermal resistance junction to case	R_{thJC}		-	-	0.13	°C/W
Thermal resistance case to heatsink	R_{thCS}	Flat, greased surface	-	0.05	-	
Weight			-	30	-	g
Mounting torque		Torque to terminal	-	-	1.1 (9.7)	Nm (lbf.in)
		Torque to heatsink	-	-	1.8 (15.9)	Nm (lbf.in)
Case style		SOT-227				



ELECTRICAL SPECIFICATIONS ($T_J = 25\text{ }^\circ\text{C}$ unless otherwise noted)						
PARAMETER	SYMBOL	TEST CONDITIONS	MIN.	TYP.	MAX.	UNITS
Collector to emitter breakdown voltage	$V_{(BR)CES}$	$V_{GE} = 0\text{ V}, I_C = 1\text{ mA}$	600	-	-	
Emitter to collector breakdown voltage	$V_{(BR)ECS}^{(1)}$	$V_{GE} = 0\text{ V}, I_C = 1.0\text{ A}$	18	-	-	
Collector to emitter voltage	$V_{CE(on)}$	$I_C = 100\text{ A}$	-	1.10	1.3	V
		$I_C = 200\text{ A}$		1.33	1.66	
		$I_C = 100\text{ A}, T_J = 125\text{ }^\circ\text{C}$		1.02	-	
		$I_C = 200\text{ A}, T_J = 125\text{ }^\circ\text{C}$		1.32	-	
		$I_C = 100\text{ A}, T_J = 150\text{ }^\circ\text{C}$		1.02	-	
		$I_C = 200\text{ A}, T_J = 150\text{ }^\circ\text{C}$		1.33	-	
Gate threshold voltage	$V_{GE(th)}$	$V_{CE} = V_{GE}, I_C = 250\text{ }\mu\text{A}$	3.0	4.5	6.0	
		$V_{CE} = V_{GE}, I_C = 250\text{ }\mu\text{A}, T_J = 125\text{ }^\circ\text{C}$	-	3.1	-	
Temperature coefficient of threshold voltage	$\Delta V_{GE(th)}/\Delta T_J$	$V_{CE} = V_{GE}, I_C = 1\text{ mA}, 25\text{ }^\circ\text{C to } 125\text{ }^\circ\text{C}$	-	-12	-	mV/°C
Collector to emitter leakage current	I_{CES}	$V_{GE} = 0\text{ V}, V_{CE} = 600\text{ V}$	-	20	1000	μA
		$V_{GE} = 0\text{ V}, V_{CE} = 600\text{ V}, T_J = 125\text{ }^\circ\text{C}$	-	0.2	-	mA
		$V_{GE} = 0\text{ V}, V_{CE} = 600\text{ V}, T_J = 150\text{ }^\circ\text{C}$	-	0.6	10	
Gate to emitter leakage current	I_{GES}	$V_{GE} = \pm 20\text{ V}$	-	-	± 250	nA

Note

(1) Pulse width $\leq 80\text{ }\mu\text{s}$; duty factor $\leq 0.1\text{ }%$

SWITCHING CHARACTERISTICS ($T_J = 25\text{ }^\circ\text{C}$ unless otherwise specified)								
PARAMETER	SYMBOL	TEST CONDITIONS	MIN.	TYP.	MAX.	UNITS		
Total gate charge (turn-on)	Q_g	$I_C = 100\text{ A}, V_{CC} = 600\text{ V}, V_{GE} = 15\text{ V}$	-	770	1200	nC		
Gate-to-emitter charge (turn-on)	Q_{ge}		-	100	150			
Gate-to-collector charge (turn-on)	Q_{gc}		-	260	380			
Turn-on switching loss	E_{on}	$T_J = 25\text{ }^\circ\text{C}$ $I_C = 100\text{ A}$ $V_{CC} = 480\text{ V}$ $V_{GE} = 15\text{ V}$ $R_g = 5.0\text{ }\Omega$ $L = 500\text{ }\mu\text{H}$	-	0.55	-	mJ		
Turn-off switching loss	E_{off}		-	25	-			
Total switching loss	E_{tot}		-	25.5	-			
Turn-on delay time	$t_{d(on)}$		Energy losses include tail and diode recovery. Diode used 60APH06	-	267	-	ns	
Rise time	t_r			-	42	-		
Turn-off delay time	$t_{d(off)}$			-	310	-		
Fall time	t_f	-		450	-			
Turn-on switching loss	E_{on}	$T_J = 125\text{ }^\circ\text{C}$ $I_C = 100\text{ A}$ $V_{CC} = 480\text{ V}$ $V_{GE} = 15\text{ V}$ $R_g = 5.0\text{ }\Omega$ $L = 500\text{ }\mu\text{H}$		-	0.67	-		mJ
Turn-off switching loss	E_{off}			-	43.0	-		
Total switching loss	E_{tot}		-	43.7	-			
Turn-on delay time	$t_{d(on)}$		Energy losses include tail and diode recovery. Diode used 60APH06	-	275	-	ns	
Rise time	t_r			-	50	-		
Turn-off delay time	$t_{d(off)}$			-	350	-		
Fall time	t_f	-		700	-			
Internal emitter inductance	L_E	Between lead and center of die contact	-	5.0	-	nH		
Input capacitance	C_{ies}	$V_{GE} = 0\text{ V}, V_{CC} = 30\text{ V}, f = 1.0\text{ MHz}$	-	16 250	-	pF		
Output capacitance	C_{oes}		-	1040	-			
Reverse transfer capacitance	C_{res}		-	190	-			

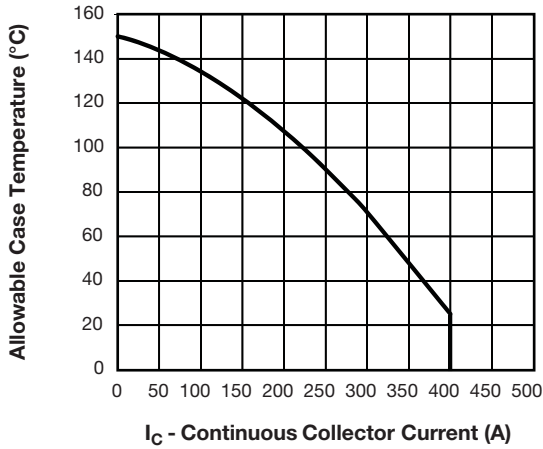

Fig. 1 - Maximum DC IGBT Collector Current vs. Case Temperature

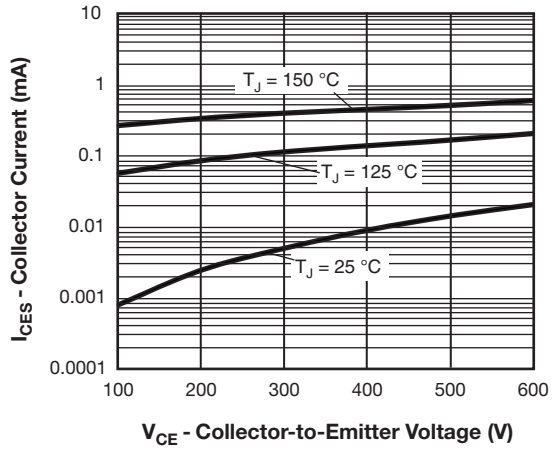

Fig. 4 - Typical IGBT Zero Gate Voltage Collector Current

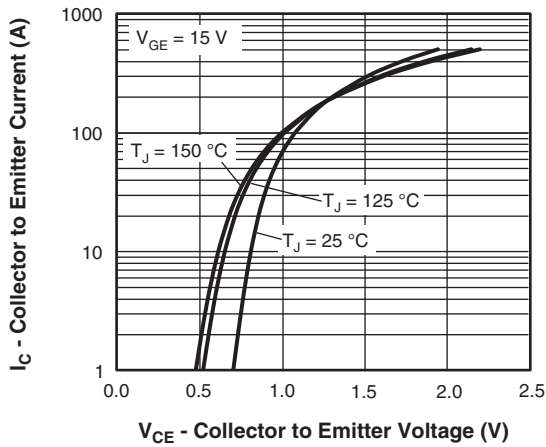

Fig. 2 - Typical Collector to Emitter Current Output Characteristics

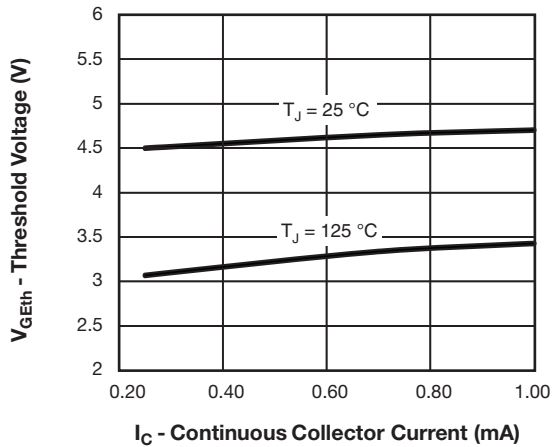

Fig. 5 - Typical IGBT Threshold Voltage

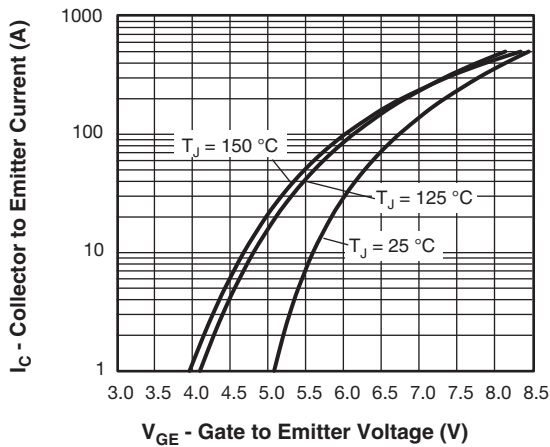

Fig. 3 - Typical IGBT Transfer Characteristics

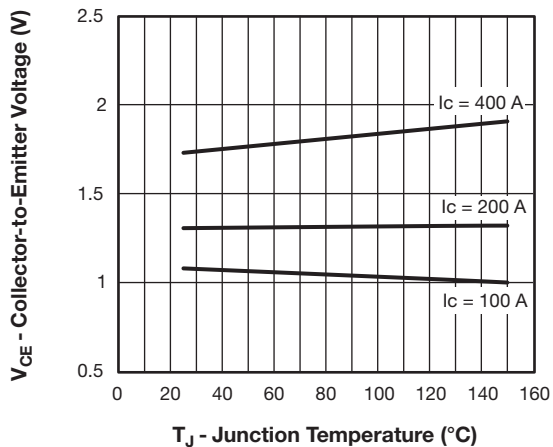

Fig. 6 - Typical IGBT Collector to Emitter Voltage vs. Junction Temperature, $V_{GE} = 15V$

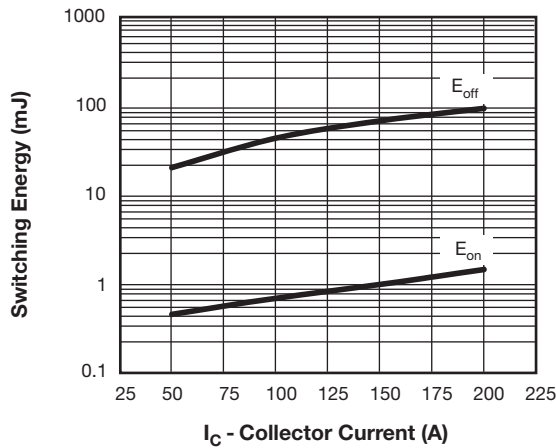

Fig. 7 - Typical IGBT Energy Losses vs. I_C , $T_J = 125^\circ\text{C}$, $V_{CC} = 480\text{ V}$, $V_{GE} = 15\text{ V}$, $L = 500\ \mu\text{H}$, $R_g = 5\ \Omega$, Diode used: 60APH06

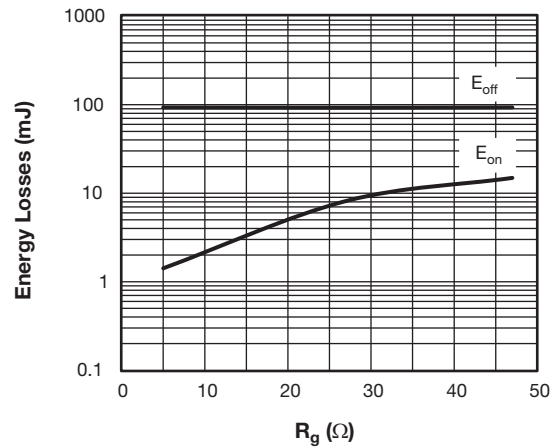

Fig. 9 - Typical IGBT Energy Losses vs. R_g , $T_J = 125^\circ\text{C}$, $I_C = 200\text{ A}$, $V_{CC} = 480\text{ V}$, $V_{GE} = 15\text{ V}$, $L = 500\ \mu\text{H}$, Diode used: 60APH06

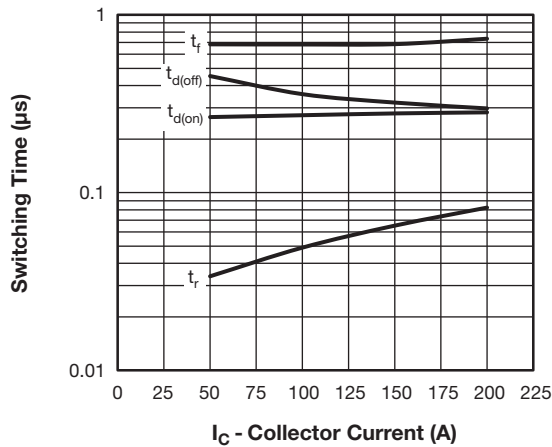

Fig. 8 - Typical IGBT Switching Time vs. I_C , $T_J = 125^\circ\text{C}$, $V_{CC} = 480\text{ V}$, $V_{GE} = 15\text{ V}$, $L = 500\ \mu\text{H}$, $R_g = 5\ \Omega$, Diode used: 60APH06

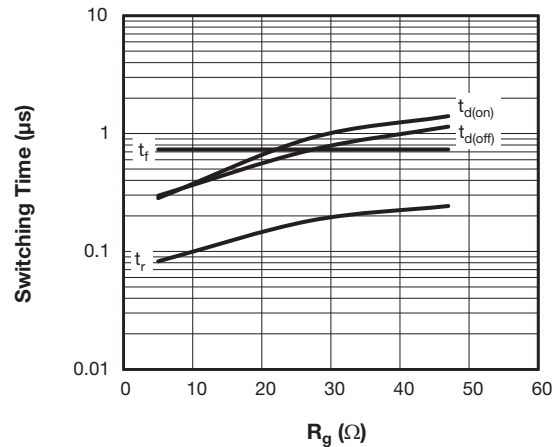

Fig. 10 - Typical IGBT Switching Time vs. R_g , $T_J = 125^\circ\text{C}$, $I_C = 200\text{ A}$, $V_{CC} = 480\text{ V}$, $V_{GE} = 15\text{ V}$, $L = 500\ \mu\text{H}$, Diode used: 60APH06

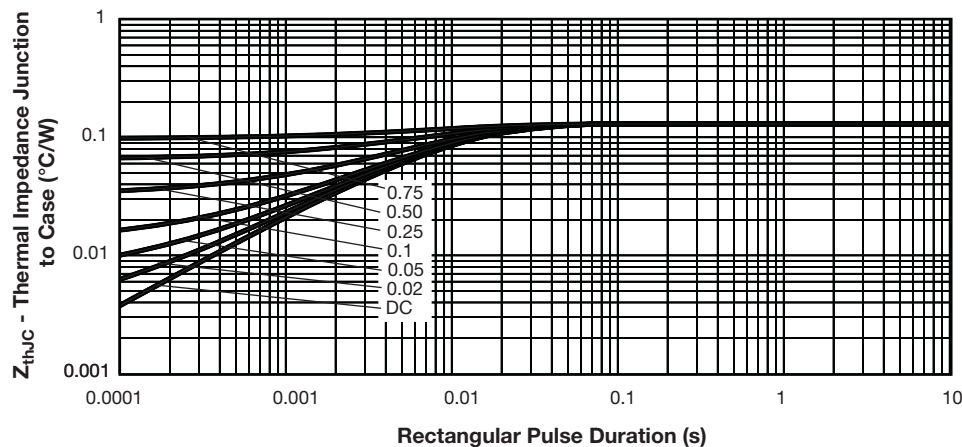

Fig. 11 - Maximum Thermal Impedance Z_{thJC} Characteristics

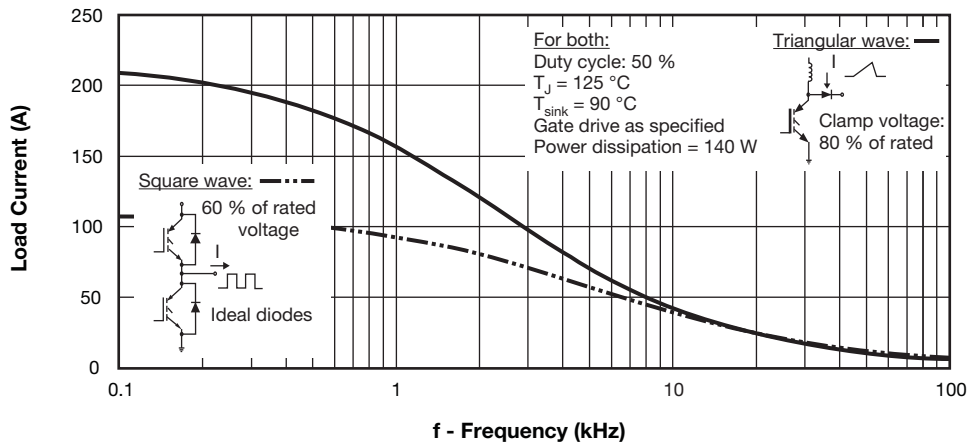

Fig. 12 - Typical Load Current vs. Frequency (Load Current = I_{RMS} of Fundamental)

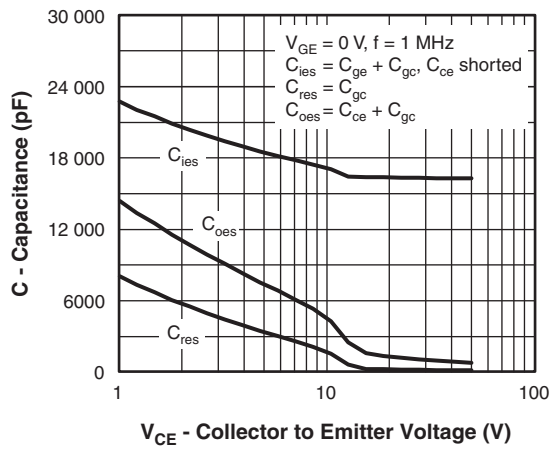

Fig. 13 - Typical Capacitance vs. Collector to Emitter Voltage

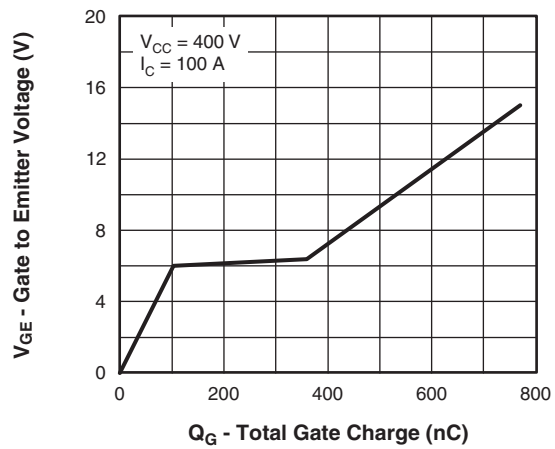

Fig. 14 - Typical Gate Charge vs. Gate to Emitter Voltage

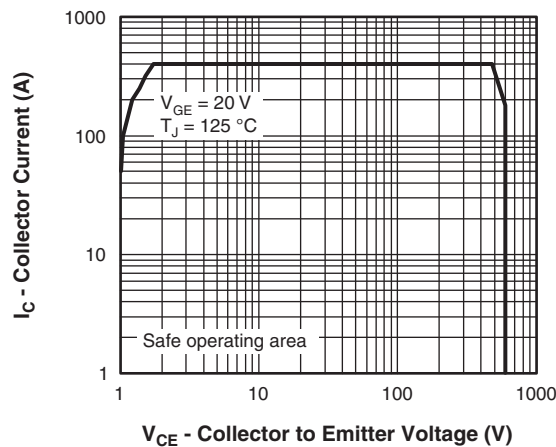
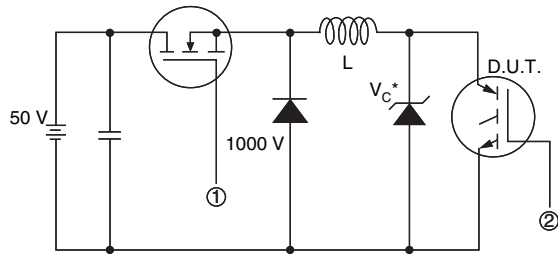

Fig. 15 - Turn-Off SOA



* Driver same type as D.U.T.; $V_C = 80\%$ of V_{CE} (max)

Note: Due to the 50 V power supply, pulse width and inductor will increase to obtain rated I_d

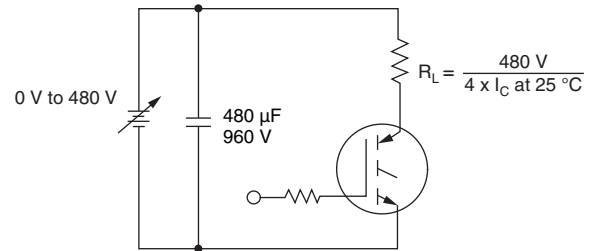
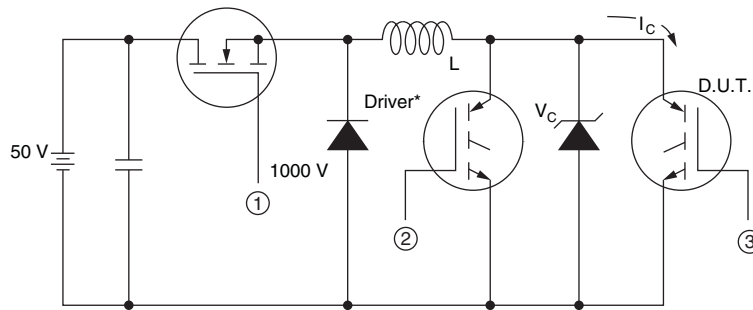

Fig. 16a - Clamped Inductive Load Test Circuit

Fig. 16b - Pulsed Collector Current Test Circuit



* Driver same type as D.U.T., $V_C = 480\text{ V}$

Fig. 17a - Switching Lost Test Circuit

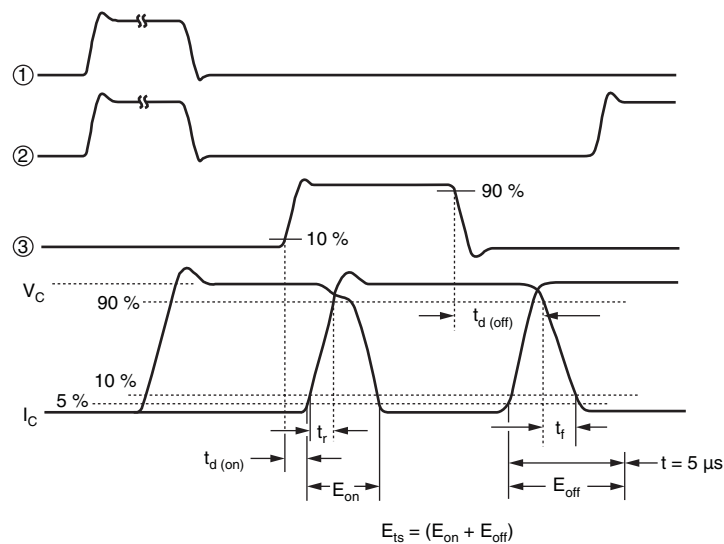

Fig. 17b - Switching Loss Waveforms

ORDERING INFORMATION TABLE

Device code	VS-	G	A	250	S	A	60	S
	1	2	3	4	5	6	7	8

- 1** - Vishay Semiconductors product
- 2** - Insulated gate bipolar transistor (IGBT)
- 3** - Gen 4, IGBT silicon
- 4** - Current rating (250 = 250 A)
- 5** - Circuit configuration (S = single switch no diode)
- 6** - Package indicator (A = SOT-227)
- 7** - Voltage rating (60 = 600 V)
- 8** - Speed/type (S = standard speed)

CIRCUIT CONFIGURATION		
CIRCUIT	CIRCUIT CONFIGURATION CODE	CIRCUIT DRAWING
Single switch, no diode	S	

LINKS TO RELATED DOCUMENTS	
Dimensions	www.vishay.com/doc?95423
Packaging information	www.vishay.com/doc?95425



SOT-227 Generation 2

DIMENSIONS in millimeters (inches)

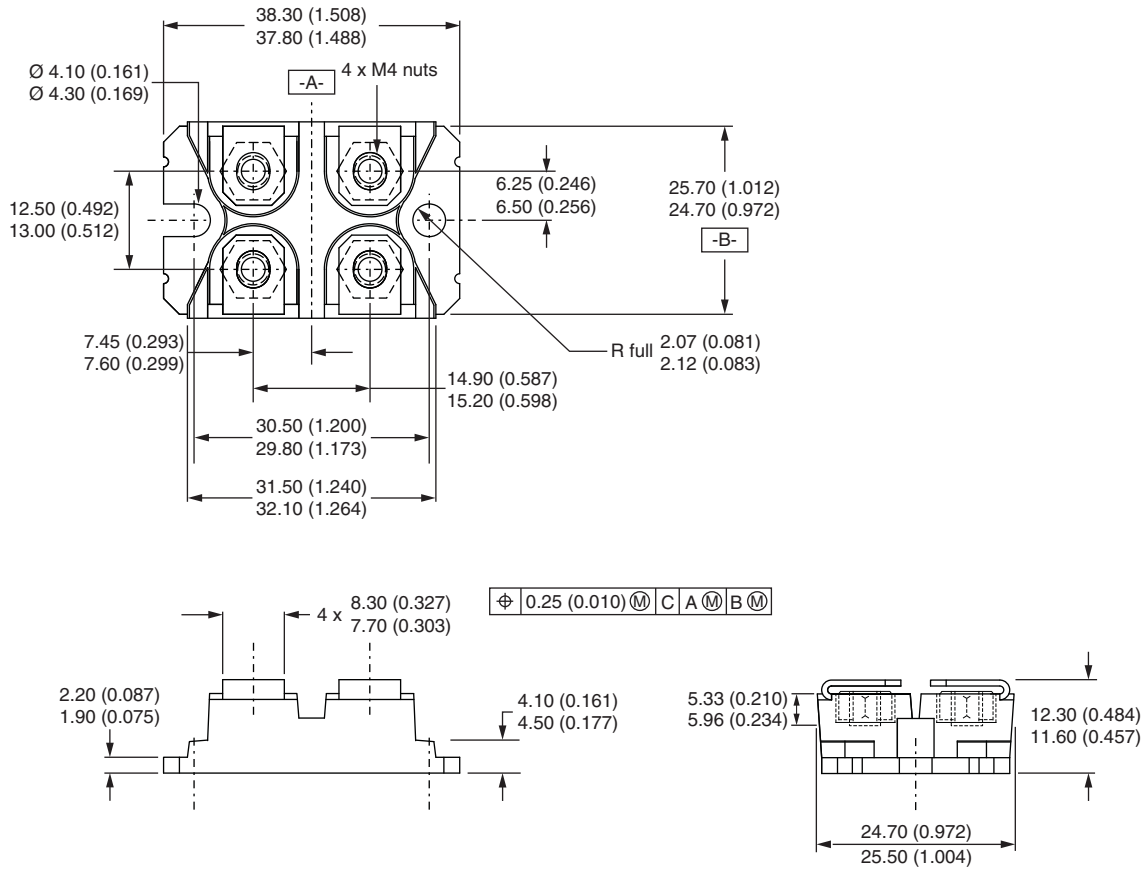

Note

- Controlling dimension: millimeter



Disclaimer

ALL PRODUCT, PRODUCT SPECIFICATIONS AND DATA ARE SUBJECT TO CHANGE WITHOUT NOTICE TO IMPROVE RELIABILITY, FUNCTION OR DESIGN OR OTHERWISE.

Vishay Intertechnology, Inc., its affiliates, agents, and employees, and all persons acting on its or their behalf (collectively, "Vishay"), disclaim any and all liability for any errors, inaccuracies or incompleteness contained in any datasheet or in any other disclosure relating to any product.

Vishay makes no warranty, representation or guarantee regarding the suitability of the products for any particular purpose or the continuing production of any product. To the maximum extent permitted by applicable law, Vishay disclaims (i) any and all liability arising out of the application or use of any product, (ii) any and all liability, including without limitation special, consequential or incidental damages, and (iii) any and all implied warranties, including warranties of fitness for particular purpose, non-infringement and merchantability.

Statements regarding the suitability of products for certain types of applications are based on Vishay's knowledge of typical requirements that are often placed on Vishay products in generic applications. Such statements are not binding statements about the suitability of products for a particular application. It is the customer's responsibility to validate that a particular product with the properties described in the product specification is suitable for use in a particular application. Parameters provided in datasheets and / or specifications may vary in different applications and performance may vary over time. All operating parameters, including typical parameters, must be validated for each customer application by the customer's technical experts. Product specifications do not expand or otherwise modify Vishay's terms and conditions of purchase, including but not limited to the warranty expressed therein.

Except as expressly indicated in writing, Vishay products are not designed for use in medical, life-saving, or life-sustaining applications or for any other application in which the failure of the Vishay product could result in personal injury or death. Customers using or selling Vishay products not expressly indicated for use in such applications do so at their own risk. Please contact authorized Vishay personnel to obtain written terms and conditions regarding products designed for such applications.

No license, express or implied, by estoppel or otherwise, to any intellectual property rights is granted by this document or by any conduct of Vishay. Product names and markings noted herein may be trademarks of their respective owners.

Mouser Electronics

Authorized Distributor

Click to View Pricing, Inventory, Delivery & Lifecycle Information:

[Vishay:](#)

[VS-GA250SA60S](#)