



**SERIES:** V78XX-2000

**DESCRIPTION:** DC SWITCHING REGULATOR,  
NON-ISOLATED

### DESCRIPTION

The V78XX switching regulator series is designed to be a high efficiency drop-in replacement for 78XX linear regulators. Unlike linear regulators, the V78XX series does not require a heatsink, creating a much more compact solution. Built-in short-circuit and over-temperature protections ensure very rugged operations. Additionally, low ripple and noise performance make the parts useful in a wide range of applications.

### FEATURES

- efficiency up to 92%
- 2A current output
- operating temp: -40 ~ +85°C
- short circuit protection
- thermal shutdown
- low ripple and noise
- miniature SIP package, meets UL94-V0 requirement
- ultra low power loss
- negative output capacity
- pin compatible to LM78XX series
- MTBF >2,000,000 hours



### MODEL

MODEL	input voltage		output voltage	output current	efficiency level	
	min (V dc)	max (V dc)	max (V dc)	max. (mA)	Vin (min)	Vin (max)
V7802-2000	4.75	18	2.5	2,000	85	83
	6.5	15	-2.5	-1,200	81	84
V7803-2000	4.75	18	3.3	2,000	87	86
	6.5	16	-3.3	-1,200	82	86
V7805-2000	7	18	5	2,000	91	88
	7	13	-5	-1,000	84	88
V7806-2000	8.5	18	6.5	2,000	92	91
	7	13	-6.5	-800	87	90

\*add suffix "R" for 90° pins, for example: V7802-2000R

### OUTPUT

parameter	conditions/description	min	nom	max	units
voltage accuracy	at 100% load		±2	±3	%
line regulation	Vin = min to max at full load		±0.5	±0.75	%
load regulation	10% to 100%		±0.5	±1.0	%
output ripple	20 MHz bandwidth, typical application circuit		25	45	mVp-p
short circuit protection	continuous, auto-restart				
short circuit input power			0.5	1.8	W
current limit			5,000		mA
switching frequency	full load, input voltage range	300	340	380	KHz
quiescent current	positive output		5	10	mA
	negative output		11	13	mA
thermal shutdown			150		°C
temperature coefficient	-40 ~ +85°C			±0.03	%/°C
load capacitance				1,000	µF



SERIES: V78XX-2000

DESCRIPTION: DC SWITCHING REGULATOR,  
NON-ISOLATED

### COMMON SPECIFICATIONS

parameter	conditions/description	min	nom	max	units
operating temperature		-40		85	°C
operating case temperature				100	°C
storage temperature		-55		125	°C
storage humidity				95	%
cooling	free air convection				
lead temperature				300	°C
case material	plastic (UL94-V0)				
MTBF		2,000,000			hours
package weight			4.0		g

### SAFETY

parameter	conditions/description	min	nom	max	units
conducted/radiated emissions	EN55022 class B				
ESD	EN61000-4-2 class A				

### MECHANICAL DRAWING

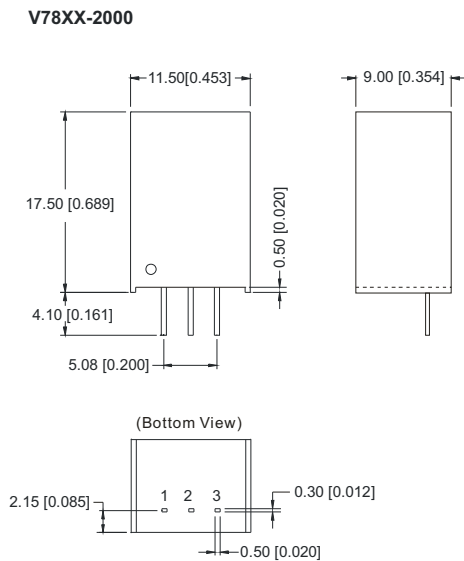

Note:  
 Unit:mm[inch]  
 Pin section tolerances:±0.10mm[±0.004inch]  
 General tolerances:±0.25mm[±0.010inch]

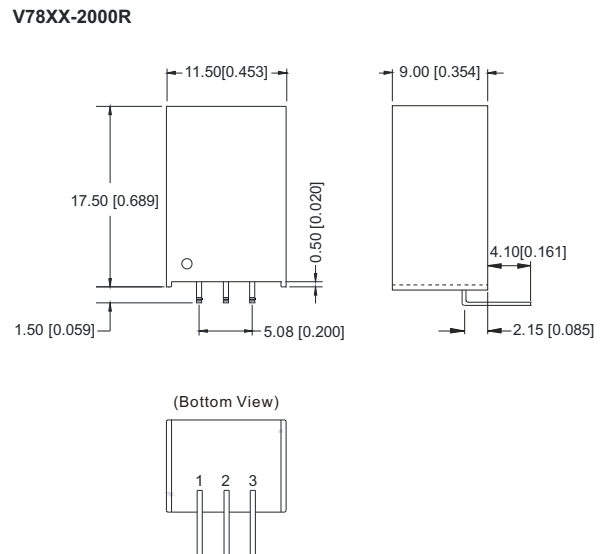

Note:  
 Unit:mm[inch]  
 Pin section tolerances:±0.10mm[±0.004inch]  
 General tolerances:±0.50mm[±0.020inch]



SERIES: V78XX-2000

DESCRIPTION: DC SWITCHING REGULATOR,  
NON-ISOLATED

## RECOMMENDED FOOTPRINT

V78XX-2000

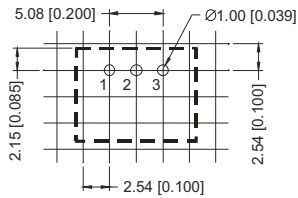

V78XX-2000R

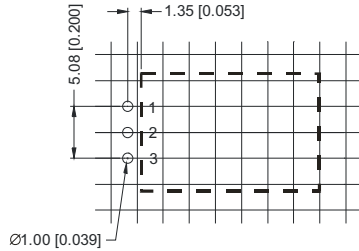

FOOTPRINT DETAILS		
Pin	Positive	Negative
1	+Vin	+Vin
2	GND	-Vout
3	+Vout	GND

## DERATING CURVE

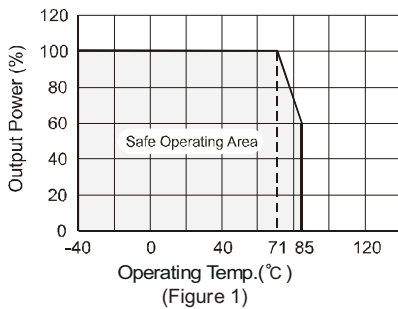

## EXTERNAL CAPACITOR TABLE

Part Number	C1 (Ceramic capacitor)	C2 (Ceramic capacitor)
V7802-2000	10 $\mu$ F/25V	22 $\mu$ F/6.3V
V7803-2000	10 $\mu$ F/25V	22 $\mu$ F/6.3V
V7805-2000	10 $\mu$ F/25V	22 $\mu$ F/16V
V7806-2000	10 $\mu$ F/25V	22 $\mu$ F/16V

## TYPICAL APPLICATION CIRCUIT

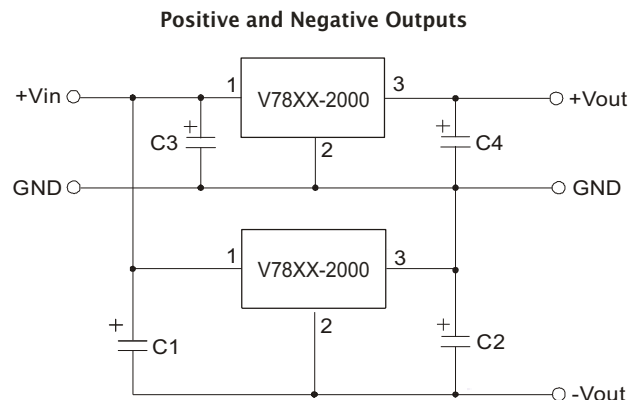
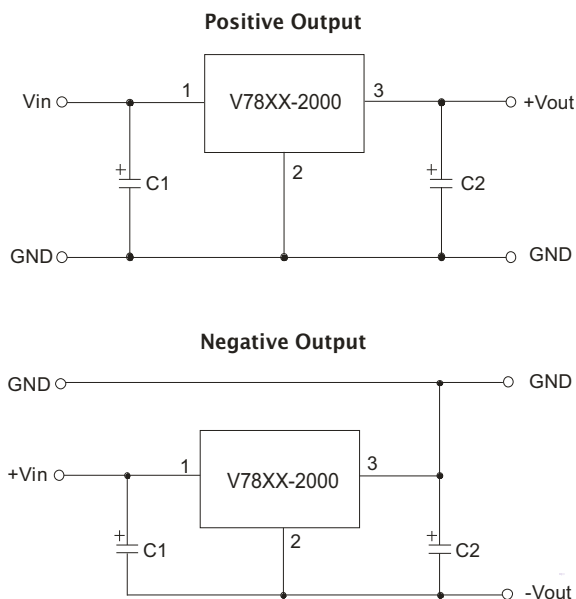

- Note:
1. C1 and C2 are required and should be fitted close to the converter pins.
  2. The capacitance of C1 and C2 sees external capacitor table, it can be increased properly if required, and tantalum or low ESR electrolytic capacitors may also suffice.
  3. No parallel connection or plug and play.



SERIES: V78XX-2000

DESCRIPTION: DC SWITCHING REGULATOR,  
NON-ISOLATED

### INPUT FILTER CIRCUIT

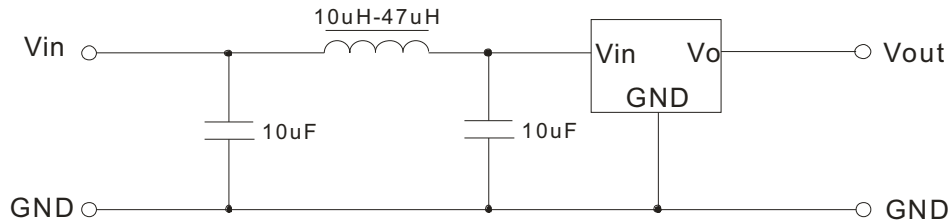

### OUTPUT FILTER CIRCUIT

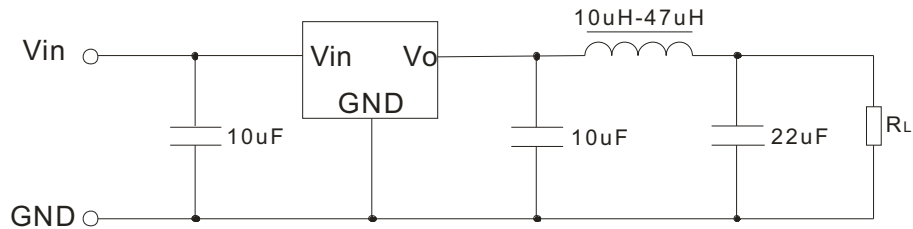

### EMC RECOMMENDED CIRCUIT

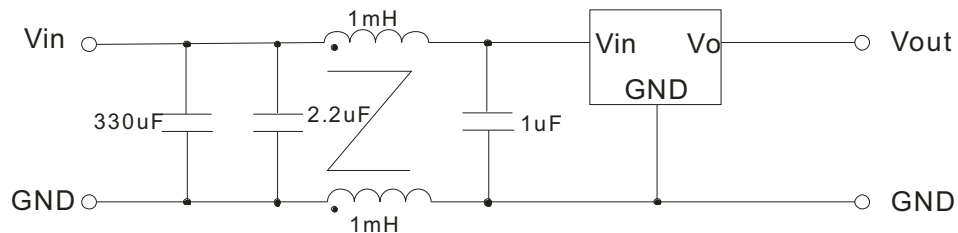



SERIES: V78XX-2000

DESCRIPTION: DC SWITCHING REGULATOR,  
NON-ISOLATED

TEST CONFIGURATION

Efficiency and Output Voltage Ripple Test

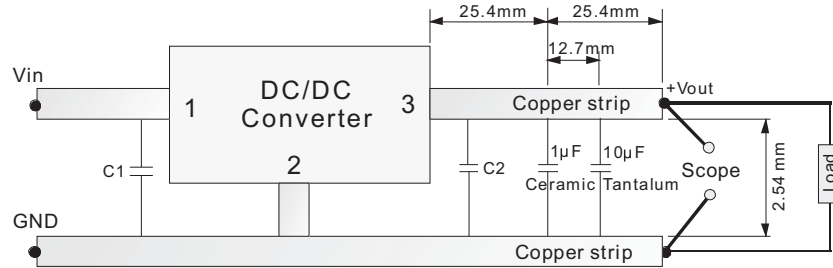

Start-up and Load Transient Response Test

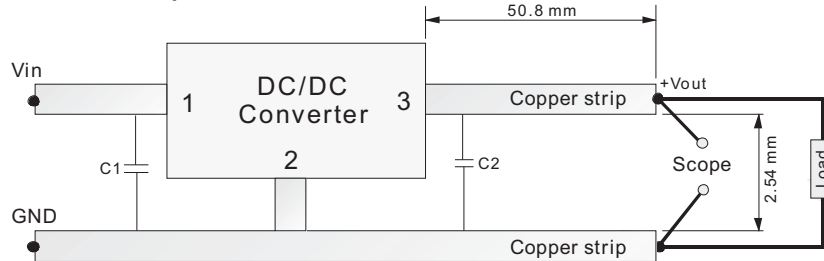

EFFICIENCY AND RIPPLE CURVES

Efficiency

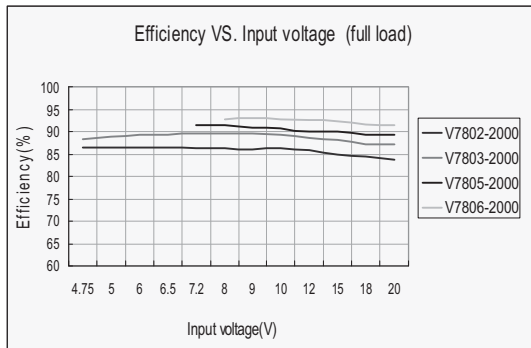

Ripple

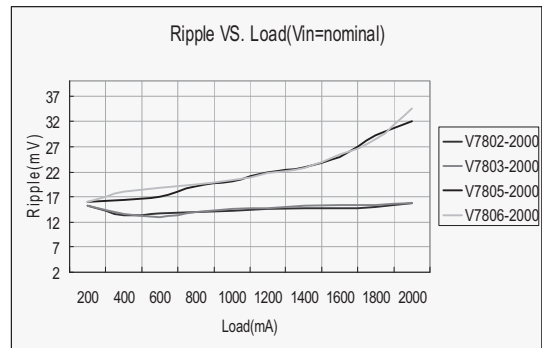

Efficiency VS. Load (Vin=nominal)

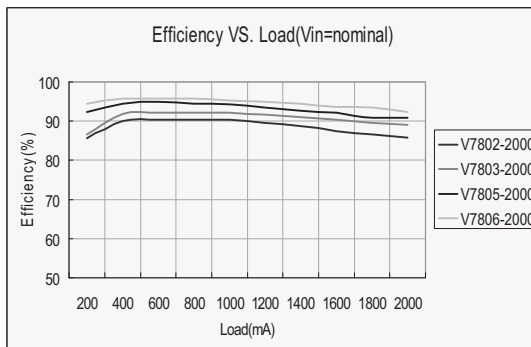

Ripple VS. Input voltage (full load)

