

SERIES: V78-1000-SMT | DESCRIPTION: NON-ISOLATED SWITCHING REGULATOR
FEATURES

- 1 A current output
- high efficiency up to 92%
- no heat sink required
- SMT package
- remote on/off control
- low ripple and noise
- short circuit protection, thermal shutdown
- wide temperature(-40°C~+85°C)



MODEL	input voltage range (Vdc)	output voltage (Vdc)	output current (mA)	output power max (W)	ripple and noise¹ max (mVp-p)	efficiency level² typ (%)
V7802-1000-SMT	5 ~ 18	2.5	1,000	2.5	35	82
V7803-1000-SMT	5 ~ 18	3.3	1,000	3.3	35	84
V7805-1000-SMT	7 ~ 18	5.0	1,000	5	35	90
V7806-1000-SMT	8.5 ~ 18	6.5	1,000	6.5	35	92

Notes: 1. 20 MHz bandwidth
2. Measured at Vin min. and 100% load

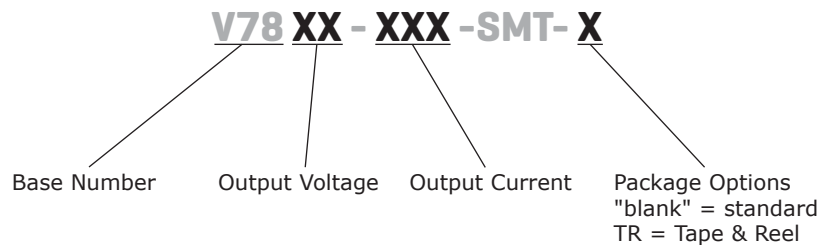
PART NUMBER KEY

INPUT

parameter	conditions/description	min	typ	max	units
operating input voltage	2.5, 3.3 V models	5.0	12	18	Vdc
	5.0 V model	7.0	12	18	Vdc
	6.5 V model	8.5	12	18	Vdc
input filter	capacitor		10		μF
remote on/off	on: open or $1.2 < V_c \leq 6$ V off: $V_c < 0.6$ V				
on/off control current	on: open or $1.2 < V_c \leq 6$ V off: GND or $V_c < 0.4$ V		100	200	μA

OUTPUT

parameter	conditions/description	min	typ	max	units
line regulation	measured from low line to high line at 100% load		±0.2	±0.5	%
load regulation	measured from 10% to full load at nominal input		±0.4	±1.0	%
voltage accuracy	measured from low line to high line at 100% load		±2	±3	%
adjustability ¹	2.5 V model	1.5		3.9	Vdc
	3.3 V model	1.8		5.5	Vdc
	5.0 V model	2.5		6.5	Vdc
	6.5 V models, fixed output				
switching frequency	PWM type		1.4		MHz
temperature coefficient	-40°C ~ +85°C ambient			±0.02	%/°C
quiescent current			1	3	mA
max capacitance load				1,000	μF

Notes: 1. Output voltage adjustment must meet $V_{in} - V_o > 2V$ requirement, see adjustment resistor values on page 4.

PROTECTIONS

parameter	conditions/description	min	typ	max	units
short circuit protection	continuous, automatic recovery (hiccup mode)				
thermal shutdown	internal IC junction		150		°C
current limit			1.8		A

SAFETY AND COMPLIANCE

parameter	conditions/description	min	typ	max	units
thermal resistance				90	°C/W
EMI/EMC	EN55022, class A and class B (refer to page 4), IEC/EN 61000-4-2 Criteria B, IEC/EN 61000-4-4 Criteria B, IEC/EN 61000-4-5 Criteria B (refer to page 4)				
RoHS compliant	yes				
MTBF	25°C (MIL-HDBK-217K)	1,000,000			hours

ENVIRONMENTAL

parameter	conditions/description	min	typ	max	units
case operating temperature				100	°C
operating temperature	power derating above 71°C	-40		85	°C
storage temperature		-55		125	°C
storage humidity				95	%

MECHANICAL

parameter	conditions/description	min	typ	max	units
dimensions	15.24 x 8.50 x 7.25 mm (0.600 x 0.335 x 0.285 inch)				
case material	Plastic (UL94-V0)				
weight			2.3		g

MECHANICAL DRAWING

units: mm [in]
 pin tolerance: ± 0.10 mm [± 0.004 in]
 general tolerance: ± 0.25 mm [± 0.010 in]

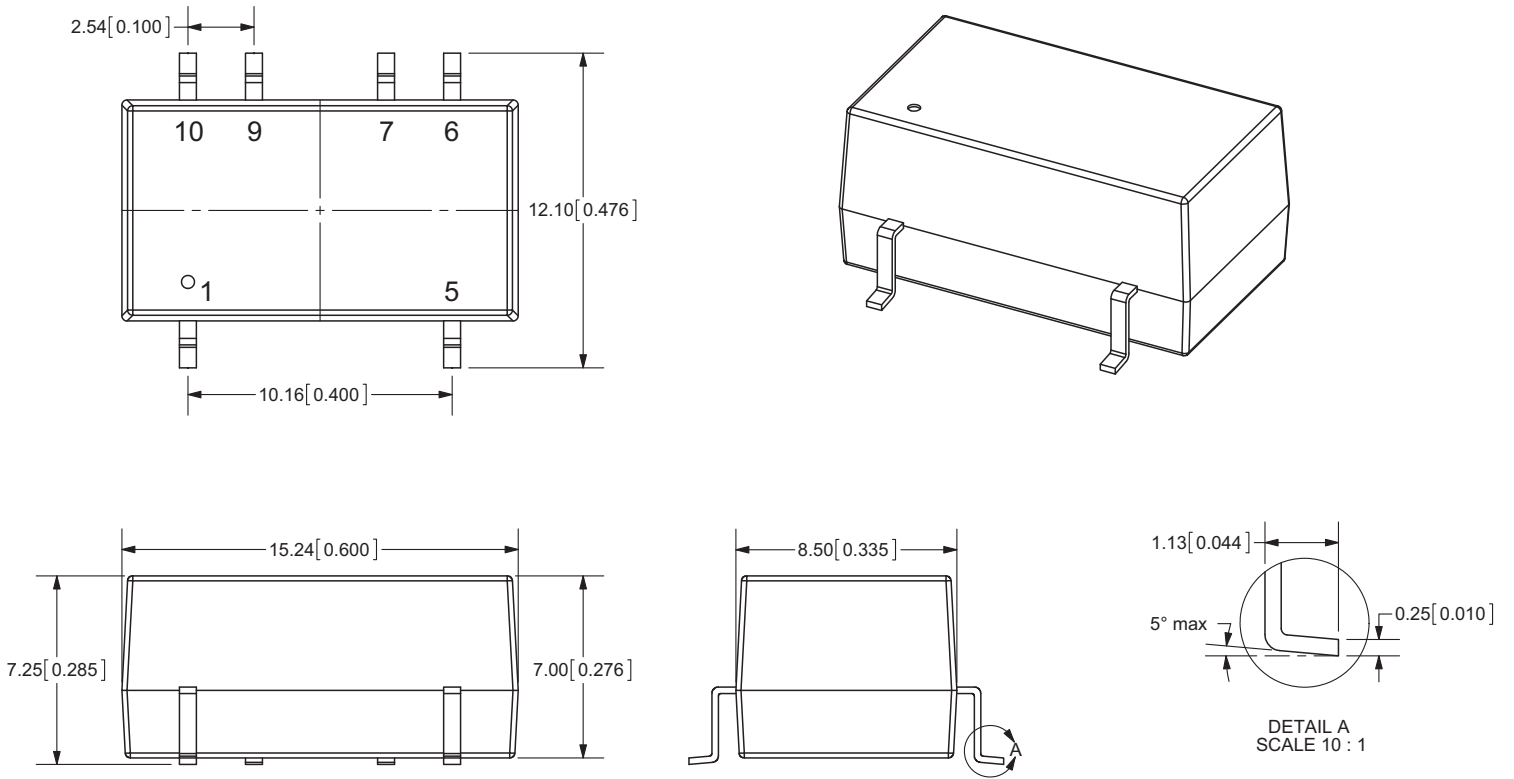

RECOMMENDED FOOTPRINT

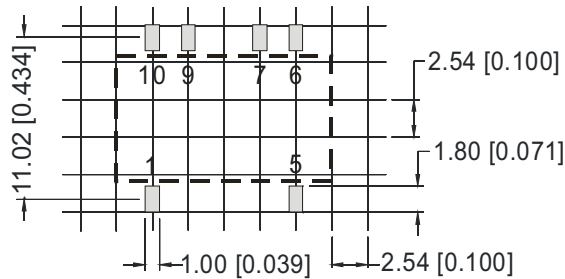

PIN CONNECTIONS	
1	+Vin
7,9	GND
5	+Vout
6	Vadj
10	On/Off

TYPICAL APPLICATION CIRCUIT

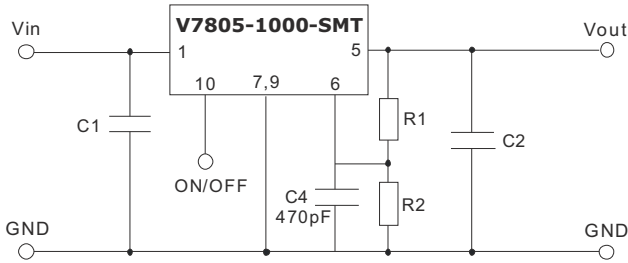

1. C1 and C2 are required for best performance and should be fitted close to the converter pins.
2. See the capacitor values for C1 and C2 in the external capacitor table below. These can be increased if required and tantalum or low ESR electrolytic capacitors will also suffice.
3. No parallel connection or plug and play.

EXTERNAL CAPACITOR TABLE		
MODEL	C1 (Ceramic)	C2 (Ceramic)
V7802-1000-SMT	10 μ F / 25 V	22 μ F / 16 V
V7803-1000-SMT	10 μ F / 25 V	22 μ F / 16 V
V7805-1000-SMT	10 μ F / 25 V	22 μ F / 16 V
V7806-1000-SMT	10 μ F / 25 V	22 μ F / 16 V

APPLICATION EXAMPLE

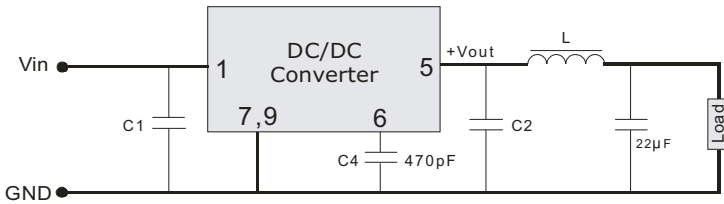

To reduce output ripple, it is recommended to add a LC filter to the output port.

L: Recommended parameter 10 ~ 47 μ H.

DERATING CURVE

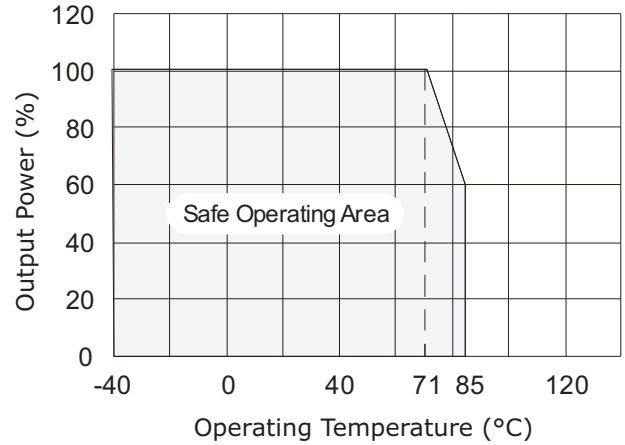

REFLOW SOLDERING PROFILE

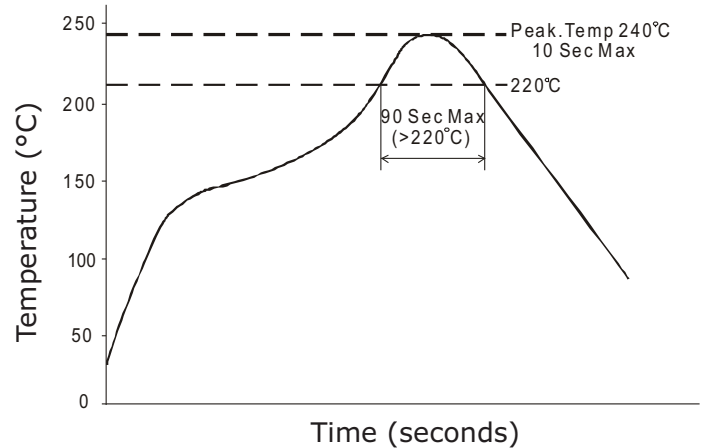

ADJUSTMENT RESISTOR VALUES

MODEL	V7802		V7803		V7805	
Vo (nominal)	2.5 V		3.3 V		5.0 V	
Vadj (V)	R1 (kΩ)	R2 (kΩ)	R1 (kΩ)	R2 (kΩ)	R1 (kΩ)	R2 (kΩ)
1.5	51.1	-	-	-	-	-
1.8	104.3	-	15.4	-	-	-
2.5	-	-	87	-	9.7	-
3.0	-	88.7	339	-	30.5	-
3.3	-	41.3	-	-	48.8	-
3.6	-	20.1	-	121	75	-
3.9	-	8.0	-	51.0	115	-
4.5	-	-	-	16.6	338	-
4.9	-	-	-	8.0	1,835	-
5.0	-	-	-	6.5	-	-
5.1	-	-	-	5.2	-	426
5.5	-	-	-	1.1	-	58.7
6.0	-	-	-	-	-	16.9
6.5	-	-	-	-	-	3.2

The R1, R2 in the above table are used to set the output voltage. If no need to adjust the output voltage, connect a ceramic capacitor to GND with 470pF typical value for increase immunity. Insure the output voltage is in the adjust range or else may cause permanent damage to the device. Fine-tune output voltage must appease $V_{in}-V_o > 2V$.

EMC RECOMMENDED CIRCUIT

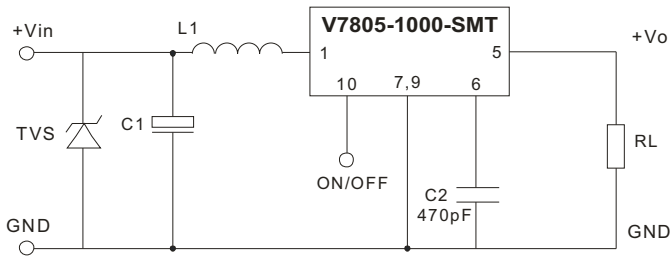

TVS: SMCJ18A, 1500W
 L1: 68 μ H
 C1: 680 μ F / 50 V electrolytic capacitors

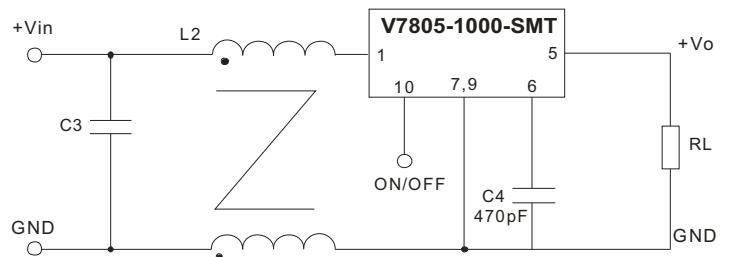

L2: 516 μ H
 C3: 1 μ F / 50 V ceramic capacitor

REVISION HISTORY

rev.	description	date
1.0	initial release	11/23/2011
1.01	V-Infinity branding removed	09/04/2012
1.02	added TR package option	10/31/2012

The revision history provided is for informational purposes only and is believed to be accurate.



CUI INC[®]

Headquarters
20050 SW 112th Ave.
Tualatin, OR 97062
800.275.4899

Fax 503.612.2383
cui.com
techsupport@cui.com

CUI offers a two (2) year limited warranty. Complete warranty information is listed on our website.

CUI reserves the right to make changes to the product at any time without notice. Information provided by CUI is believed to be accurate and reliable. However, no responsibility is assumed by CUI for its use, nor for any infringements of patents or other rights of third parties which may result from its use.

CUI products are not authorized or warranted for use as critical components in equipment that requires an extremely high level of reliability. A critical component is any component of a life support device or system whose failure to perform can be reasonably expected to cause the failure of the life support device or system, or to affect its safety or effectiveness.