

Features

- **Ultra Low-power consumption**
 - Active: 35mA I_{CC} at 55ns
 - Stand-by: 5 μ A (CMOS input/output)
1 μ A (CMOS input/output, L version)
- 55/70/85/100 ns access time
- Equal access and cycle time
- Single +2.2V to 2.7V Power Supply
- Tri-state output
- Automatic power-down when deselected
- Multiple center power and ground pins for improved noise immunity
- Individual byte controls for both Read and Write cycles
- Available in 44 pin TSOP (II) Package

Functional Description

The V62C2161024L is a Low Power CMOS Static RAM organized as 65,536 words by 16 bits. Easy memory expansion is provided by an active LOW (\overline{CE}) and (\overline{OE}) pin.

This device has an automatic power-down mode feature when deselected. Separate Byte Enable controls (\overline{BLE} and \overline{BHE}) allow individual bytes to be accessed. \overline{BLE} controls the lower bits I/O1 - I/O8. \overline{BHE} controls the upper bits I/O9 - I/O16.

Writing to these devices is performed by taking Chip Enable (\overline{CE}) with Write Enable (\overline{WE}) and Byte Enable ($\overline{BLE}/\overline{BHE}$) LOW.

Reading from the device is performed by taking Chip Enable (\overline{CE}) with Output Enable (\overline{OE}) and Byte Enable ($\overline{BLE}/\overline{BHE}$) LOW while Write Enable (\overline{WE}) is held HIGH.

Logic Block Diagram

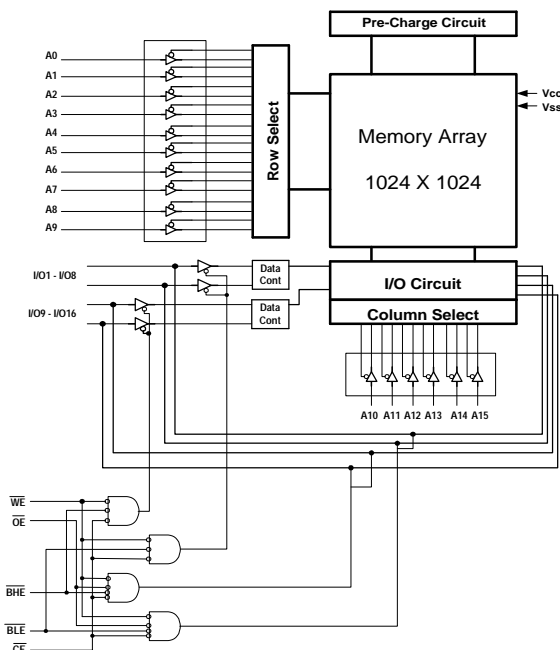

TSOP(II)

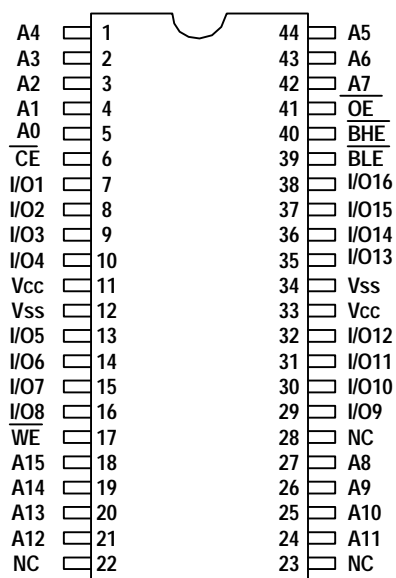

Absolute Maximum Ratings *

Parameter	Symbol	Minimum	Maximum	Unit
Voltage on Any Pin Relative to Gnd	Vt	-0.5	+4.6	V
Power Dissipation	PT	–	1.0	W
Storage Temperature (Plastic)	Tstg	-55	+150	°C
Temperature Under Bias	Tbias	-40	+85	°C

* **Note:** Stresses greater than those listed above Absolute Maximum Ratings may cause permanent damage to the device. This is a stress rating only and function operation of the device at these or any other conditions outside those indicated in the operational sections of this specification is not implied. Exposure to Absolute Maximum Rating conditions for extended periods may affect reliability.

Truth Table

CE	OE	WE	BLE	BHE	I/O1-I/O8	I/O9-I/O16	Power	Mode
H	X	X	X	X	High-Z	High-Z	Standby	Standby
L	L	H	L	H	Data Out	High-Z	Active	Low Byte Read
L	L	H	H	L	High-Z	Data Out	Active	High Byte Read
L	L	H	L	L	Data Out	Data Out	Active	Word Read
L	X	L	L	L	Data In	Data In	Active	Word Write
L	X	L	L	H	Data In	High-Z	Active	Low Byte Write
L	X	L	H	L	High-Z	Data In	Active	High Byte Write
L	H	H	X	X	High-Z	High-Z	Active	Output Disable
L	X	X	H	H	High-Z	High-Z	Active	Output Disable

* **Key:** X = Don't Care, L = Low, H = High

Recommended Operating Conditions (T_A = 0°C to +70°C / -40°C to 85°C)**

Parameter	Symbol	Min	Typ	Max	Unit
Supply Voltage	V _{CC}	2.2	2.5	2.7	V
	Gnd	0.0	0.0	0.0	V
Input Voltage	V _{IH}	2.0	-	V _{CC} + 0.2	V
	V _{IL}	-0.5*	-	0.6	V

* V_{IL} min = -2.0V for pulse width less than t_{RC}/2.

** For Industrial Temperature

DC Operating Characteristics ($V_{CC} = 2.2$ to $2.7V$, $Gnd = 0V$, $T_A = 0^{\circ}C$ to $+70^{\circ}C$ / $-40^{\circ}C$ to $85^{\circ}C$)

Parameter	Sym	Test Conditions	-55		-70		-85		-100		Unit	
			Min	Max	Min	Max	Min	Max	Min	Max		
Input Leakage Current	I_{LI}	$V_{CC} = Max,$ $V_{in} = Gnd$ to V_{CC}	-	1	-	1	-	1	-	1	μA	
Output Leakage Current	I_{LO}	$\overline{CE} = V_{IH}$ or $V_{CC} = Max,$ $V_{OUT} = Gnd$ to V_{CC}	-	1	-	1	-	1	-	1	μA	
Operating Power Supply Current	I_{CC}	$\overline{CE} = V_{IL}, V_{IN} = V_{IH}$ or $V_{IL},$ $I_{OUT} = 0$	-	3	-	3	-	3	-	3	mA	
Average Operating Current	I_{CC1}	$I_{OUT} = 0mA,$ Min Cycle, 100% Duty	-	35	-	30	-	25	-	25	mA	
	I_{CC2}	$\overline{CE} \leq 0.2V$ $I_{OUT} = 0mA,$ Cycle Time= $1\mu s,$ Duty=100%	-	3	-	3	-	3	-	3	mA	
Standby Power Supply Current (TTL Level)	I_{SB}	$\overline{CE} = V_{IH}$	-	0.5	-	0.5	-	0.5	-	0.5	mA	
Standby Power Supply Current (CMOS Level)	I_{SB1}	$\overline{CE} \geq V_{CC} - 0.2V$ $V_{IN} \leq 0.2V$ or $V_{IN} \geq V_{CC} - 0.2V$	L	-	5	-	5	-	5	-	5	μA
			LL	-	1	-	1	-	1	-	1	μA
Output Low Voltage	V_{OL}	$I_{OL} = 2 mA$	-	0.4	-	0.4	-	0.4	-	0.4	V	
Output High Voltage	V_{OH}	$I_{OH} = -2 mA$	2.0	-	2.0	-	2.0	-	2.0	-	V	

Capacitance ($f = 1MHz,$ $T_A = 25^{\circ}C$)

Parameter*	Symbol	Test Condition	Max	Unit
Input Capacitance	C_{in}	$V_{in} = 0V$	7	pF
I/O Capacitance	$C_{I/O}$	$V_{in} = V_{out} = 0V$	8	pF

* This parameter is guaranteed by device characterization and is not production tested.

AC Test Conditions

Input Pulse Level $0.6V$ to $2.0V$
Input Rise and Fall Time $5ns$
Input and Output Timing $1.2V$
Reference Level

Output Load Condition
 $55ns/70ns/85ns$ $C_L = 30pf + 1TTL$ Load
Load for 100ns $C_L = 100pf + 1TTL$ Load

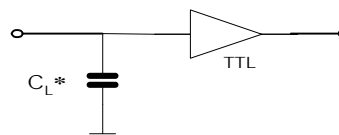

Figure A. * Including Scope and Jig Capacitance

Read Cycle ⁽⁹⁾ ($V_{cc} = 2.2V$ to $2.7V$, $Gnd = 0V$, $T_A = 0^{\circ}C$ to $+70^{\circ}C$ / $-40^{\circ}C$ to $+85^{\circ}C$)

Parameter	Sym	-55		-70		-85		-100		Unit	Note
		Min	Max	Min	Max	Min	Max	Min	Max		
Read Cycle Time	t_{RC}	55	-	70	-	85	-	100	-	ns	
Address Access Time	t_{AA}	-	55	-	70	-	85	-	100	ns	
Chip Enable Access Time	t_{ACE}	-	55	-	70	-	85	-	100	ns	
Output Enable Access Time	t_{OE}	-	35	-	40	-	40	-	50	ns	
Output Hold from Address Change	t_{OH}	10	-	10	-	10	-	10	-	ns	
Chip Enable to Output in Low-Z	t_{LZ}	10	-	10	-	10	-	10	-	ns	4,5
Chip Disable to Output in High-Z	t_{HZ}	-	25	-	30	-	35	-	40	ns	3,4,5
Output Enable to Output in Low-Z	t_{OLZ}	5	-	5	-	5	-	5	-	ns	
Output Disable to Output in High-Z	t_{OHZ}	-	25	-	25	-	30	-	35	ns	
\overline{BLE} , \overline{BHE} Enable to Output in Low-Z	t_{BLZ}	5	-	5	-	5	-	5	-	ns	4,5
\overline{BLE} , \overline{BHE} Disable to Output in High-Z	t_{BHZ}	-	25	-	25	-	30	-	35	ns	3,4,5
\overline{BLE} , \overline{BHE} Access Time	t_{BA}	-	35	-	40	-	40	-	50	ns	

Write Cycle ⁽¹¹⁾ ($V_{cc} = 2.2V$ to $2.7V$, $Gnd = 0V$, $T_A = 0^{\circ}C$ to $+70^{\circ}C$ / $-40^{\circ}C$ to $+85^{\circ}C$)

Parameter	Symbol	-55		-70		-85		-100		Unit	Note
		Min	Max	Min	Max	Min	Max	Min	Max		
Write Cycle Time	t_{WC}	55	-	70	-	85	-	100	-	ns	
Chip Enable to Write End	t_{CW}	50	-	60	-	70	-	80	-	ns	
Address Setup to Write End	t_{AW}	50	-	60	-	70	-	80	-	ns	
Address Setup Time	t_{AS}	0	-	0	-	0	-	0	-	ns	
Write Pulse Width	t_{WP}	45	-	50	-	60	-	70	-	ns	
Write Recovery Time	t_{WR}	0	-	0	-	0	-	0	-	ns	
Data Valid to Write End	t_{DW}	25	-	30	-	35	-	40	-	ns	
Data Hold Time	t_{DH}	0	-	0	-	0	-	0	-	ns	
Write Enable to Output in High-Z	t_{WHZ}	-	25	-	30	-	35	-	40	ns	
Output Active from Write End	t_{OW}	5	-	5	-	5	-	5	-	ns	
\overline{BLE} , \overline{BHE} Setup to Write End	t_{BW}	50	-	60	-	70	-	80	-	ns	

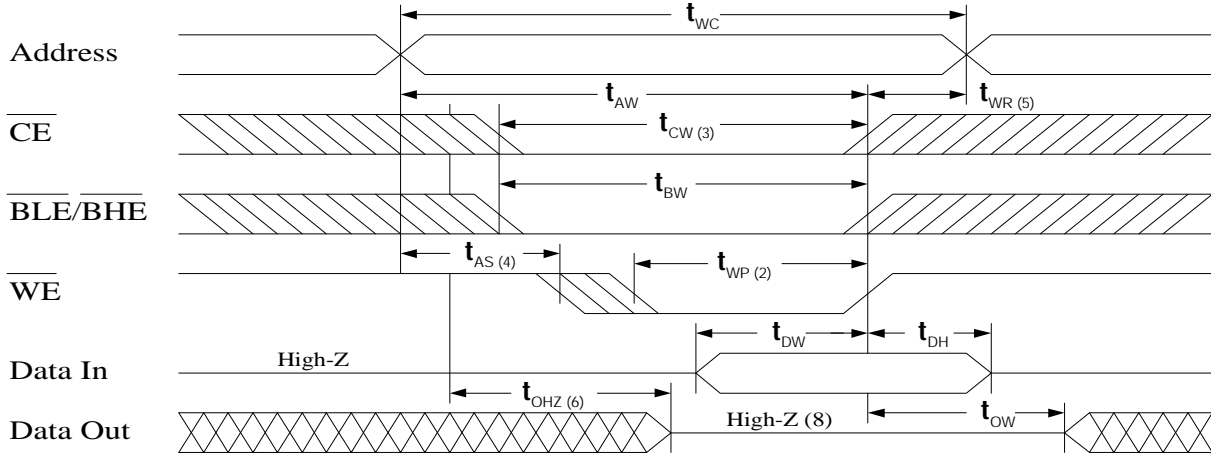
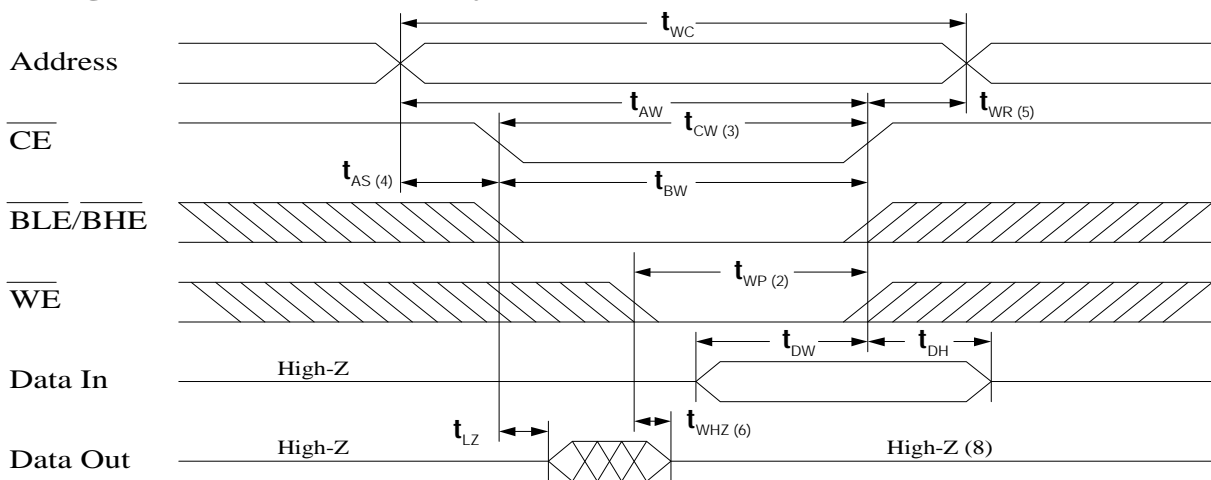
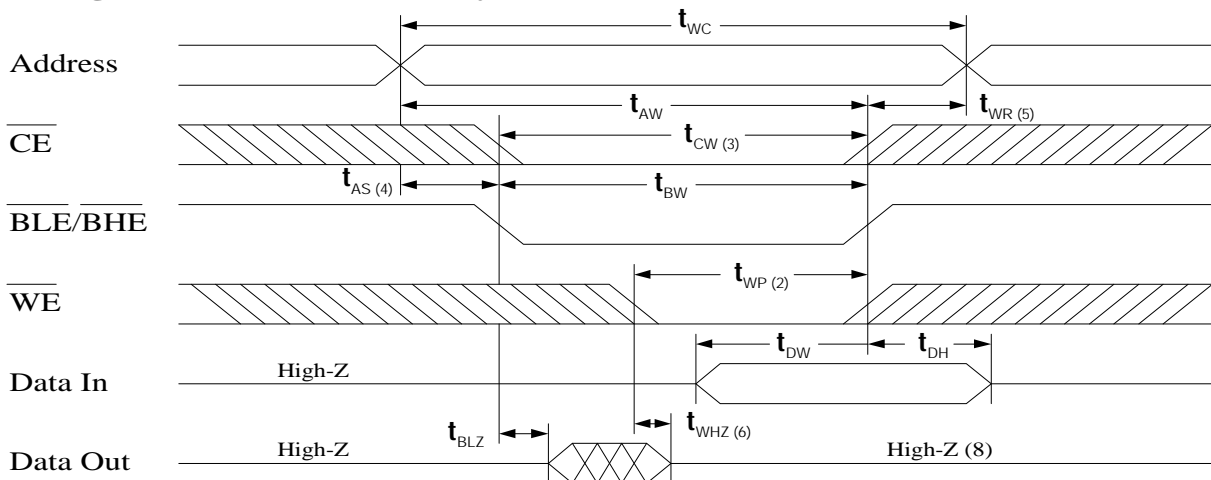
Timing Waveform of Write Cycle 1 (Address Controlled)

Timing Waveform of Write Cycle 2 (CE Controlled)

Timing Waveform of Write Cycle 3 (BLE/BHE Controlled)

Notes (Write Cycle)

1. All write timing is referenced from the last valid address to the first transition address.
2. A write occurs during the overlap of a low \overline{CE} and \overline{WE} . A write begins at the latest transition among \overline{CE} and \overline{WE} going low: A write ends at the earliest transition among \overline{CE} going high and \overline{WE} going high. t_{WP} is measured from the beginning of write to the end of write.
3. t_{CW} is measured from the later of \overline{CE} going low to end of write.
4. t_{AS} is measured from the address valid to the beginning of write.
5. t_{WR} is measured from the end of write to the address change.
6. If \overline{OE} , \overline{CE} and \overline{WE} are in the Read Mode during this period, the I/O pins are in the output Low-Z state. Inputs of opposite phase of the output must not be applied because bus contention can occur.
7. For common I/O applications, minimization or elimination of bus contention conditions is necessary during read and write cycle.
8. If \overline{CE} goes low simultaneously with \overline{WE} going low or after \overline{WE} going low, the outputs remain high impedance state.
9. D_{OUT} is the read data of the new address.
10. When \overline{CE} is low: I/O pins are in the outputs state. The input signals in the opposite phase leading to the output should not be applied.
11. For test conditions, see *AC Test Condition*, Figure A.

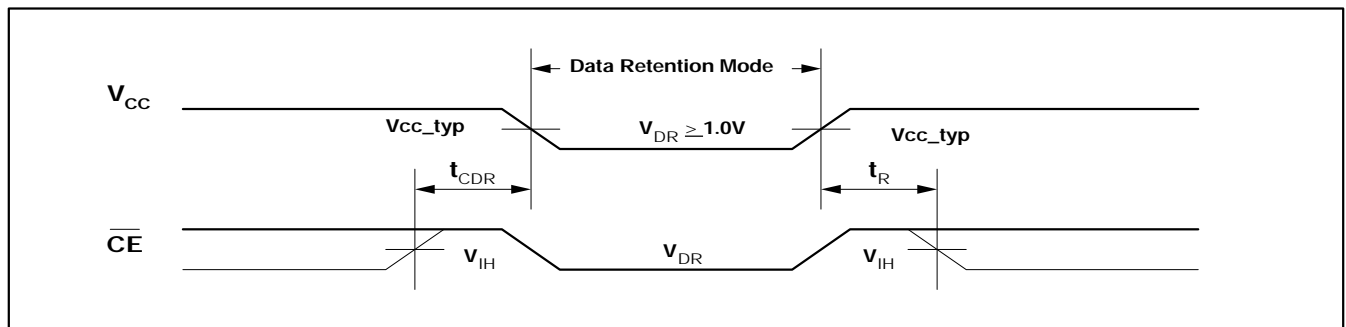
Data Retention Characteristics (L Version Only)⁽¹⁾

Parameter	Symbol	Test Condition	Min	Max	Unit
V _{CC} for Data Retention	V _{DR}	$\overline{CE} \geq V_{CC} - 0.2V$	1.0	-	V
Data Retention Current	I _{CCDR}		-	1	μA
Chip Deselect to Data Retention Time	t _{CDR}	V _{IN} ≥ V _{CC} - 0.2V or	0	-	ns
Operation Recovery Time ⁽²⁾	t _R	V _{IN} ≤ 0.2V	t _{RC}	-	ns

Data Retention Waveform (L Version Only) (T_A = 0⁰C to +70⁰C / -40⁰C to +85⁰C)

Notes (Write Cycle)

1. L-version includes this feature.
2. This Parameter is sampled and not 100% tested.
3. For test conditions, see *AC Test Condition*, Figure A.
4. This parameter is tested with CL = 5pF as shown in Figure B. Transition is measured ± 500mV from steady-state voltage.
5. This parameter is guaranteed, but is not tested.
6. \overline{WE} is High for read cycle.
7. \overline{CE} and \overline{OE} are LOW for read cycle.
8. Address valid prior to or coincident with \overline{CE} transition LOW.
9. All read cycle timings are referenced from the last valid address to the first transition address.
10. \overline{CE} or \overline{WE} must be HIGH during address transition.
11. All write cycle timings are referenced from the last valid address to the first transition address.



Ordering Information

Device Type*	Speed	Package
V62C2161024L-55T	55 ns	44-pin TSOP Type 2
V62C2161024L-70T	70 ns	
V62C2161024L-85T	85 ns	
V62C2161024L-100T	100 ns	
V62C2161024LL-55T	55 ns	
V62C2161024LL-70T	70 ns	
V62C2161024LL-85T	85 ns	
V62C2161024LL-100T	100 ns	

* For Industrial temperature tested devices, an "T" designator will be added to the end of the device number.

U.S.A.

3910 NORTH FIRST STREET
SAN JOSE, CA 95134
PHONE: 408-433-6000
FAX: 408-433-0952

TAIWAN

7F, NO. 102
MIN-CHUAN E. ROAD, SEC. 3
TAIPEI
PHONE: 886-2-2545-1213
FAX: 886-2-2545-1209

SINGAPORE

10 ANSON ROAD #23-13
INTERNATIONAL PLAZA
SINGAPORE 079903
PHONE: 65-3231801
FAX: 65-3237013

UK & IRELAND

SUITE 50, GROVEWOOD
BUSINESS CENTRE
STRATHCLYDE BUSINESS
PARK
BELLSHILL, LANARKSHIRE,
SCOTLAND, ML4 3NQ
PHONE: 44-1698-748515
FAX: 44-1698-748516

NO 19 LI HSIN ROAD
SCIENCE BASED IND. PARK
HSIN CHU, TAIWAN, R.O.C.
PHONE: 886-3-579-5888
FAX: 886-3-566-5888

JAPAN

ONZE 1852 BUILDING 6F
2-14-6 SHINTOMI, CHUO-KU
TOKYO 104-0041
PHONE: 03-3537-1400
FAX: 03-3537-1402

**GERMANY
(CONTINENTAL
EUROPE & ISRAEL)**

BENZSTRASSE 32
71083 HERRENBERG
GERMANY
PHONE: +49 7032 2796-0
FAX: +49 7032 2796 22

U.S. SALES OFFICES**NORTHWESTERN**

3910 NORTH FIRST STREET
SAN JOSE, CA 95134
PHONE: 408-433-6000
FAX: 408-433-0952

SOUTHWESTERN

302 N. EL CAMINO REAL #200
SAN CLEMENTE, CA 92672
PHONE: 949-361-7873
FAX: 949-361-7807

**CENTRAL,
NORTHEASTERN &
SOUTHEASTERN**

604 FIELDWOOD CIRCLE
RICHARDSON, TX 75081
PHONE: 214-826-6176
FAX: 214-828-9754

The information in this document is subject to change without notice.

MOSEL VITELIC makes no commitment to update or keep current the information contained in this document. No part of this document may be copied or reproduced in any form or by any means without the prior written consent of MOSEL-VITELIC.

MOSEL VITELIC subjects its products to normal quality control sampling techniques which are intended to provide an assurance of high quality products suitable for usual commercial applications. MOSEL VITELIC does not do testing appropriate to provide 100% product quality assurance and does not assume any liability for consequential or incidental arising from any use of its products. If such products are to be used in applications in which personal injury might occur from failure, purchaser must do its own quality assurance testing appropriate to such applications.