

**Features**

- High-speed: 85, 100 ns
- Ultra low CMOS standby current of 2µA (max.)
- Fully static operation
- All inputs and outputs directly TTL compatible
- Three state outputs
- Ultra low data retention current ( $V_{CC} = 1.0V$ )
- Operating voltage: 1.8V – 2.3V
- Packages
  - 48-Ball CSP BGA (8mm x 10mm)

**Description**

The V62C18164096 is a 4,194,304-bit static random-access memory organized as 262,144 words by 16 bits. Inputs and three-state outputs are TTL compatible and allow for direct interfacing with common system bus structures.

**Functional Block Diagram**

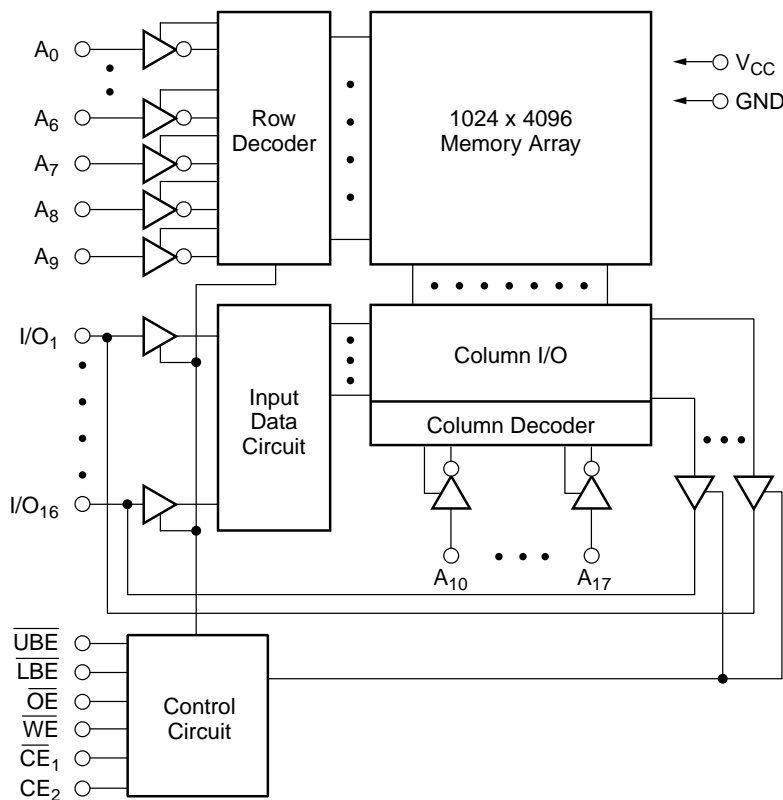

**Device Usage Chart**

Operating Temperature Range	Package Outline	Access Time (ns)		Power		Temperature Mark
	B	85	100	L	LL	
0°C to 70°C	•	•	•	•	•	Blank
-40°C to +85°C	•	•	•		•	I

**Pin Descriptions**

**A<sub>0</sub>-A<sub>17</sub> Address Inputs**

These 18 address inputs select one of the 256K x 16 bit segments in the RAM.

**$\overline{CE}_1$ , CE<sub>2</sub> Chip Enable Inputs**

$\overline{CE}_1$  is active LOW and CE<sub>2</sub> is active HIGH. Both chip enables must be active to read from or write to the device. If either chip enable is not active, the device is deselected and is in a standby power mode. The I/O pins will be in the high-impedance state when deselected.

**$\overline{OE}$  Output Enable Input**

The output enable input is active LOW. With the chip enabled, when  $\overline{OE}$  is Low and  $\overline{WE}$  High, data will be presented on the I/O pins. The I/O pins will be in the high impedance state when  $\overline{OE}$  is High.

**$\overline{UBE}$ ,  $\overline{LBE}$  Byte Enable**

Active low inputs. These inputs are used to enable the upper or lower data byte.

**$\overline{WE}$  Write Enable Input**

The write enable input is active LOW and controls read and write operations. With the chip enabled, when  $\overline{WE}$  is HIGH and  $\overline{OE}$  is LOW, output data will be present at the I/O pins; when  $\overline{WE}$  is LOW and  $\overline{OE}$  is HIGH, the data present on the I/O pins will be written into the selected memory locations.

**I/O<sub>1</sub>-I/O<sub>16</sub> Data Input and Data Output Ports**

These 16 bidirectional ports are used to read data from and write data into the RAM.

**V<sub>CC</sub> Power Supply**

**GND Ground**

**Pin Configurations (Top View)**

**48 BGA**

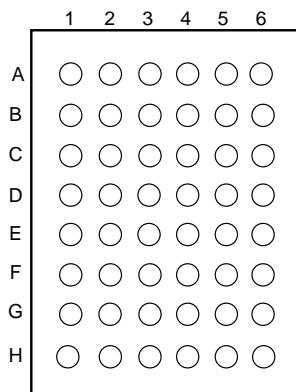

TOP VIEW

	1	2	3	4	5	6
A	$\overline{BLE}$	OE	A0	A1	A2	CE <sub>2</sub>
B	I/O9	$\overline{BHE}$	A3	A4	$\overline{CE}_1$	I/O1
C	I/O10	I/O11	A5	A6	I/O2	I/O3
D	VSS	I/O12	A17	A7	I/O4	VCC
E	VCC	I/O13	NC	A16	I/O5	VSS
F	I/O15	I/O14	A14	A15	I/O6	I/O7
G	I/O16	NC	A12	A13	$\overline{WE}$	I/O8
H	NC	A8	A9	A10	A11	NC

Note: NC means no connect.

TOP VIEW

**Part Number Information**

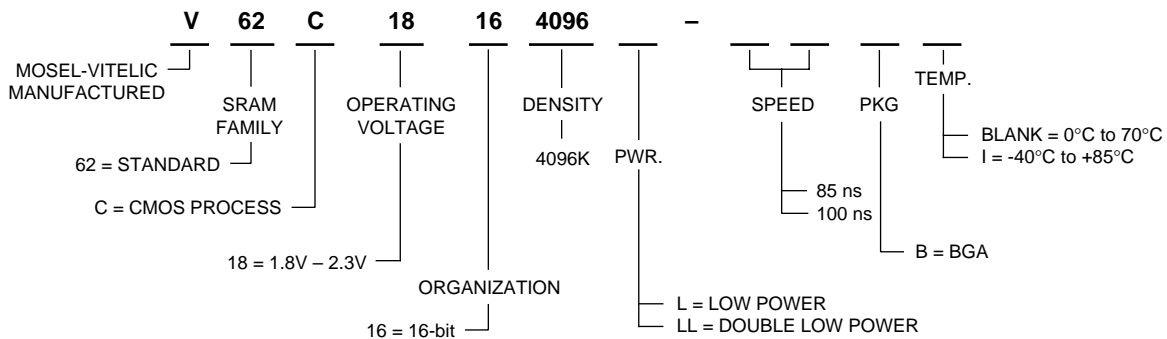

**Absolute Maximum Ratings (1)**

Symbol	Parameter	Commercial	Industrial	Units
V <sub>CC</sub>	Supply Voltage	-0.5 to V <sub>CC</sub> + 0.5	-0.5 to V <sub>CC</sub> + 0.5	V
V <sub>N</sub>	Input Voltage	-0.5 to V <sub>CC</sub> + 0.5	-0.5 to V <sub>CC</sub> + 0.5	V
V <sub>DQ</sub>	Input/Output Voltage Applied	V <sub>CC</sub> + 0.3	V <sub>CC</sub> + 0.3	V
T <sub>BIAS</sub>	Temperature Under Bias	-10 to +125	-65 to +135	°C
T <sub>STG</sub>	Storage Temperature	-55 to +125	-65 to +150	°C

**NOTE:**

- Stresses greater than those listed under "Absolute Maximum Ratings" may cause permanent damage to the device. This is a stress rating only and functional operation of the device at these or any other conditions above those indicated in the operational sections of this specification is not implied. Exposure to absolute maximum rating conditions for extended periods may affect reliability.

**Capacitance\* T<sub>A</sub> = 25°C, f = 1.0MHz**

Symbol	Parameter	Conditions	Max.	Unit
C <sub>IN</sub>	Input Capacitance	V <sub>IN</sub> = 0V	6	pF
C <sub>OUT</sub>	Output Capacitance	V <sub>I/O</sub> = 0V	8	pF

**NOTE:**

- This parameter is guaranteed and not tested.

**Truth Table**

Mode	$\overline{CE}_1$	CE <sub>2</sub>	OE	WE	$\overline{UBE}$	LBE	I/O <sub>9-16</sub> Operation	I/O <sub>1-8</sub> Operation
Standby	H	X	X	X	X	X	High Z	High Z
Standby	X	L	X	X	X	X	High Z	High Z
Output Disable	L	H	X	X	H	H	High Z	High Z
Output Disable	L	H	H	H	X	X	High Z	High Z
Read	L	H	L	H	L	L	D <sub>OUT</sub>	D <sub>OUT</sub>
Read	L	H	L	H	L	H	D <sub>OUT</sub>	High Z
Read	L	H	L	H	H	L	High Z	D <sub>OUT</sub>
Write	L	H	X	L	L	L	D <sub>IN</sub>	D <sub>IN</sub>
Write	L	H	X	L	L	H	D <sub>IN</sub>	High Z
Write	L	H	X	L	H	L	High Z	D <sub>IN</sub>

**NOTE:**

X = Don't Care, L = LOW, H = HIGH

**DC Electrical Characteristics** (over all temperature ranges,  $V_{CC} = 1.8V - 2.3V$ )

Symbol	Parameter	Test Conditions	Min.	Typ.	Max.	Units
$V_{IL}$	Input LOW Voltage <sup>(1,2)</sup>		-0.3	—	0.4	V
$V_{IH}$	Input HIGH Voltage <sup>(1)</sup>		1.6	—	$V_{CC} + 0.3$	V
$I_{IL}$	Input Leakage Current	$V_{CC} = \text{Max}, V_{IN} = 0V \text{ to } V_{CC}$	-1	—	1	$\mu A$
$I_{OL}$	Output Leakage Current	$V_{CC} = \text{Max}, \overline{CE} = V_{IH}, V_{OUT} = 0V \text{ to } V_{CC}$	-1	—	1	$\mu A$
$V_{OL}$	Output LOW Voltage	$V_{CC} = \text{Min}, I_{OL} = 2.1mA$	—	—	0.4	V
$V_{OH}$	Output HIGH Voltage	$V_{CC} = \text{Min}, I_{OH} = -0.1mA$	$V_{CC} - 0.4$	—	—	V

Symbol	Parameter	Power	Com. <sup>(3)</sup>	Ind. <sup>(3)</sup>	Units
$I_{CC1}$	Average Operating Current, $\overline{CE}_1 = V_{IL}, CE_2 = V_{CC} - 0.2V$ , Output Open, $V_{CC} = \text{Max}$ .	$f = f_{max}$	25	30	mA
		$f = 1 \text{ MHz}$	2	3	
$I_{SB}$	TTL Standby Current $CE \geq V_{IH}, V_{CC} = \text{Max.}, f = 0$	L	0.4	0.5	mA
		LL	0.3	0.3	
$I_{SB1}$	CMOS Standby Current, $\overline{CE}_1 \geq V_{CC} - 0.2V, CE_2 < 0.2V$ $V_{IN} \geq V_{CC} - 0.2V$ or $V_{IN} \leq 0.2V, V_{CC} = \text{Max.}, f = 0$	L	5	7	$\mu A$
		LL	2	3	

**NOTES:**

1. These are absolute values with respect to device ground and all overshoots due to system or tester noise are included.
2.  $V_{IL}$  (Min.) = -3.0V for pulse width < 20ns.
3. Maximum values.

**AC Test Conditions**

Input Pulse Levels	0 to 1.6V
Input Rise and Fall Times	5 ns
Timing Reference Levels	0.9V
Output Load	see below

**AC Test Loads and Waveforms**

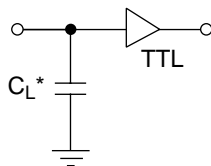

\* Includes scope and jig capacitance  
 $C_L = 30 \text{ pF} + 1 \text{ TTL Load}$

**Key to Switching Waveforms**

WAVEFORM	INPUTS	OUTPUTS
	MUST BE STEADY	WILL BE STEADY
	MAY CHANGE FROM H TO L	WILL BE CHANGING FROM H TO L
	MAY CHANGE FROM L TO H	WILL BE CHANGING FROM L TO H
	DON'T CARE: ANY CHANGE PERMITTED	CHANGING: STATE UNKNOWN
	DOES NOT APPLY	CENTER LINE IS HIGH IMPEDANCE "OFF" STATE

**Data Retention Characteristics**

Symbol	Parameter	Power	Min.	Typ. <sup>(2)</sup>	Max.	Units	
$V_{DR}$	$V_{CC}$ for Data Retention $\overline{CE}_1 \geq V_{CC} - 0.2V$ , $CE_2 < 0.2V$ , $V_{IN} \geq V_{CC} - 0.2V$ , or $V_{IN} \leq 0.2V$		1.0	—	2.3	V	
$I_{CCDR}$	Data Retention Current $\overline{CE}_1 \geq V_{DR} - 0.2V$ , $CE_2 < 0.2V$ , $V_{IN} \geq V_{CC} - 0.2V$ , or $V_{IN} \leq 0.2V$ , $V_{DR} = 1.0V$	Com'l	L	—	1	3	$\mu A$
			LL	—	0.5	1.5	
		Ind.	L	—	—	5	
			LL	—	—	2	
$t_{CDR}$	Chip Deselect to Data Retention Time		0	—	—	ns	
$t_R$	Operation Recovery Time (see Retention Waveform)		$t_{RC}^{(1)}$	—	—	ns	

**NOTES:**

- $t_{RC}$  = Read Cycle Time
- $T_A = +25^\circ C$ .

**Low  $V_{CC}$  Data Retention Waveform ( $\overline{CE}$  Controlled)**

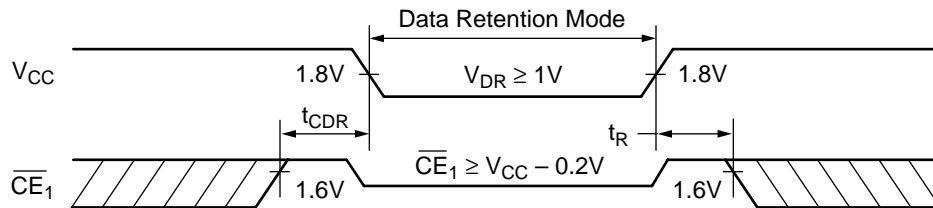

**AC Electrical Characteristics**

(over all temperature ranges)

**Read Cycle**

Parameter Name	Parameter	85		100		Unit
		Min.	Max.	Min.	Max.	
t <sub>RC</sub>	Read Cycle Time	85	—	70	—	ns
t <sub>AA</sub>	Address Access Time	—	85	—	100	ns
t <sub>ACS</sub>	Chip Enable Access Time	—	85	—	100	ns
t <sub>BA</sub>	$\overline{\text{UBE}}$ , $\overline{\text{LBE}}$ Access Time	—	85	—	100	ns
t <sub>OE</sub>	Output Enable to Output Valid	—	35	—	40	ns
t <sub>CLZ</sub>	Chip Enable to Output in Low Z	10	—	15	—	ns
t <sub>BLZ</sub>	$\overline{\text{UBE}}$ , $\overline{\text{LBE}}$ to Output in Low Z	10	—	15	—	ns
t <sub>OLZ</sub>	Output Enable to Output in Low Z	10	—	10	—	ns
t <sub>CHZ</sub>	Chip Disable to Output in High Z	0	30	0	35	ns
t <sub>OHZ</sub>	Output Disable to Output in High Z	0	30	0	35	ns
t <sub>BHZ</sub>	$\overline{\text{UBE}}$ , $\overline{\text{LBE}}$ to Output in High Z	0	30	0	35	ns
t <sub>OH</sub>	Output Hold from Address Change	10	—	10	—	ns

**Write Cycle**

Parameter Name	Parameter	85		100		Unit
		Min.	Max.	Min.	Max.	
t <sub>WC</sub>	Write Cycle Time	85	—	100	—	ns
t <sub>CW</sub>	Chip Enable to End of Write	70	—	80	—	ns
t <sub>AS</sub>	Address Setup Time	0	—	0	—	ns
t <sub>AW</sub>	Address Valid to End of Write	70	—	80	—	ns
t <sub>WP</sub>	Write Pulse Width	60	—	70	—	ns
t <sub>WR</sub>	Write Recovery Time	0	—	0	—	ns
t <sub>WHZ</sub>	Write to Output High-Z	0	25	0	35	ns
t <sub>DW</sub>	Data Setup to End of Write	40	—	45	—	ns
t <sub>DH</sub>	Data Hold from End of Write	0	—	0	—	ns
t <sub>BW</sub>	$\overline{\text{UBE}}$ , $\overline{\text{LBE}}$ to End of Write	70	—	80	—	ns

**Switching Waveforms (Read Cycle)**

**Read Cycle 1<sup>(1, 2)</sup>**

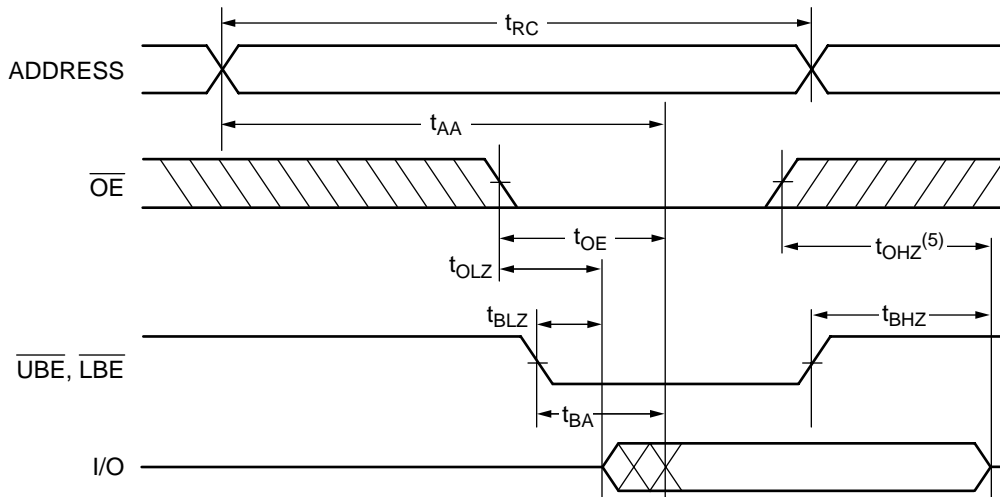

**Read Cycle 2<sup>(1, 2, 4, 6)</sup>**

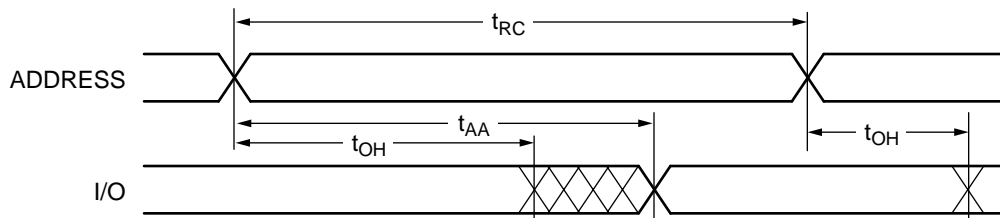

**Read Cycle 3<sup>(1, 3, 4, 6)</sup>**

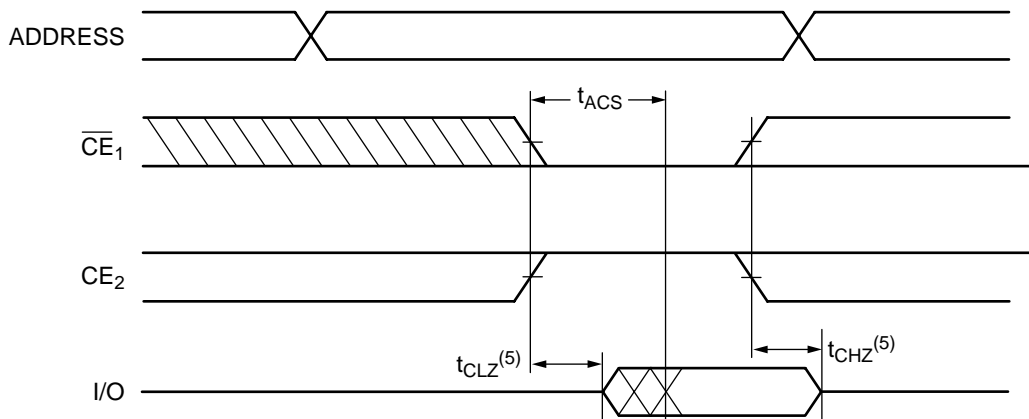

**NOTES:**

1.  $\overline{WE} = V_{IH}$ .
2.  $\overline{CE}_1 = V_{IL}$ ,  $CE_2 = V_{IH}$ .
3. Address valid prior to or coincident with  $\overline{CE}$  transition LOW.
4.  $\overline{OE} = V_{IL}$ .
5. Transition is measured  $\pm 500mV$  from steady state with  $C_L = 5pF$ . This parameter is guaranteed and not 100% tested.
6.  $\overline{UBE} = V_{IL}$ ,  $\overline{LBE} = V_{IL}$ .

**Switching Waveforms (Write Cycle)**

**Write Cycle 1 ( $\overline{WE}$  Controlled)<sup>(4)</sup>**

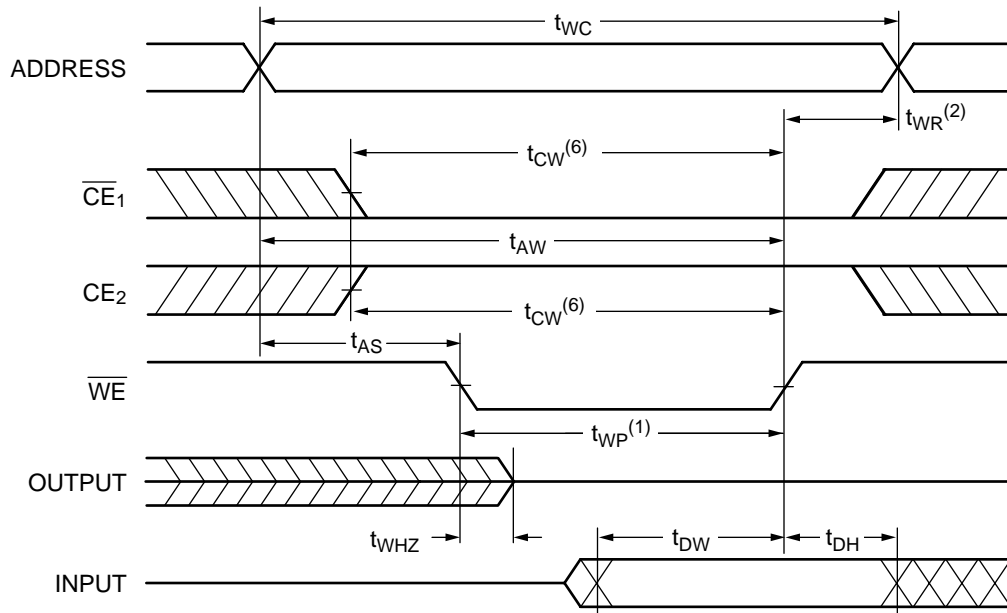

**Write Cycle 2 (CE Controlled)<sup>(4)</sup>**

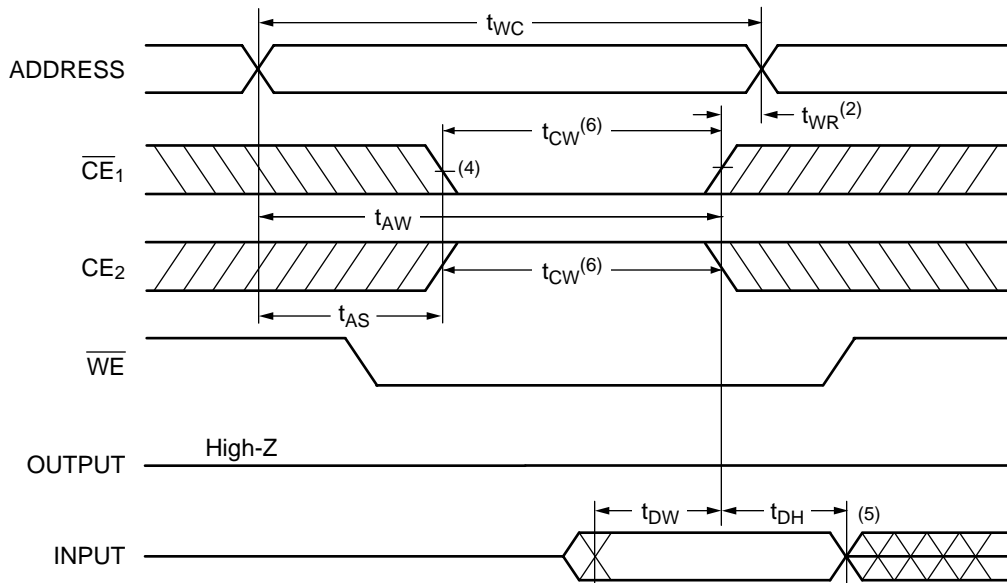

**NOTES:**

1. The internal write time of the memory is defined by the overlap of  $\overline{CE}_1$  and  $CE_2$  active and  $\overline{WE}$  low. All signals must be active to initiate and any one signal can terminate a write by going inactive. The data input setup and hold timing should be referenced to the second transition edge of the signal that terminates the write.
2.  $t_{WR}$  is measured from the earlier of  $\overline{CE}_1$  or  $\overline{WE}$  going high, or  $CE_2$  going LOW at the end of the write cycle.
3. During this period, I/O pins are in the output state so that the input signals of opposite phase to the outputs must not be applied.
4.  $\overline{OE} = V_{IL}$  or  $V_{IH}$ . However it is recommended to keep  $\overline{OE}$  at  $V_{IH}$  during write cycle to avoid bus contention.
5. If  $\overline{CE}_1$  is LOW and  $CE_2$  is HIGH during this period, I/O pins are in the output state. Then the data input signals of opposite phase to the outputs must not be applied to them.
6.  $t_{CW}$  is measured from  $\overline{CE}_1$  going low or  $CE_2$  going HIGH to the end of write.



**Package Diagrams**

**48 Ball—8x10 BGA**

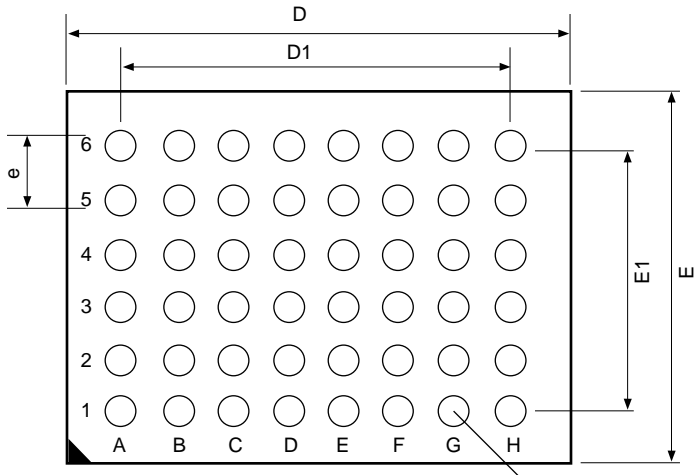

SYMBOL	UNIT.MM
A	1.05+0.15
A1	0.25±0.05
b	0.35±0.05
c	0.30(TYP)
D	10.00±0.10
D1	5.25
E	8.00±0.10
E1	3.75
e	0.75TYP
aaa	0.10

BOTTOM VIEW

b  
SOLDER BALL

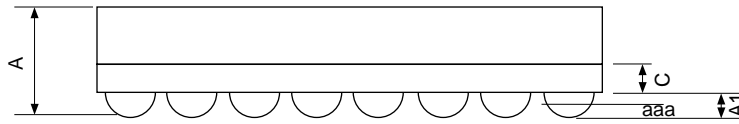

SIDE VIEW

**U.S.A.**

3910 NORTH FIRST STREET  
SAN JOSE, CA 95134  
PHONE: 408-433-6000  
FAX: 408-433-0952

**HONG KONG**

19 DAI FU STREET  
TAIPO INDUSTRIAL ESTATE  
TAIPO, NT, HONG KONG  
PHONE: 852-2666-3307  
FAX: 852-2770-8011

**TAIWAN**

7F, NO. 102  
MIN-CHUAN E. ROAD, SEC. 3  
TAIPEI  
PHONE: 886-2-2545-1213  
FAX: 886-2-2545-1209

NO 19 LI HSIN RD.  
SCIENCE BASED IND. PARK  
HSIN CHU, TAIWAN, R.O.C.  
PHONE: 886-3-579-5888  
FAX: 886-3-566-5888

**SINGAPORE**

10 ANSON ROAD #23-13  
INTERNATIONAL PLAZA  
SINGAPORE 079903  
PHONE: 65-3231801  
FAX: 65-3237013

**JAPAN**

WBG MARIVE WEST 25F  
6, NAKASE 2-CHOME  
MIHAMA-KU, CHIBA-SHI  
CHIBA 261-7125  
PHONE: 81-43-299-6000  
FAX: 81-43-299-6555

**UK & IRELAND**

SUITE 50, GROVEWOOD  
BUSINESS CENTRE  
STRATHCLYDE BUSINESS  
PARK  
BELLSHILL, LANARKSHIRE,  
SCOTLAND, ML4 3NQ  
PHONE: 01698-748515  
FAX: 01698-748516

**GERMANY  
(CONTINENTAL  
EUROPE & ISRAEL)**

71083 HERRENBERG  
BENZSTR. 32  
GERMANY  
PHONE: +49 7032 2796-0  
FAX: +49 7032 2796 22

**U.S. SALES OFFICES****NORTHWESTERN**

3910 NORTH FIRST STREET  
SAN JOSE, CA 95134  
PHONE: 408-433-6000  
FAX: 408-433-0952

**SOUTHWESTERN**

302 N. EL CAMINO REAL #200  
SAN CLEMENTE, CA 92672  
PHONE: 949-361-7873  
FAX: 949-361-7807

**CENTRAL,  
NORTHEASTERN &  
SOUTHEASTERN**

604 FIELDWOOD CIRCLE  
RICHARDSON, TX 75081  
PHONE: 972-690-1402  
FAX: 972-690-0341

---

The information in this document is subject to change without notice.

MOSEL VITELIC makes no commitment to update or keep current the information contained in this document. No part of this document may be copied or reproduced in any form or by any means without the prior written consent of MOSEL-VITELIC.

MOSEL VITELIC subjects its products to normal quality control sampling techniques which are intended to provide an assurance of high quality products suitable for usual commercial applications. MOSEL VITELIC does not do testing appropriate to provide 100% product quality assurance and does not assume any liability for consequential or incidental arising from any use of its products. If such products are to be used in applications in which personal injury might occur from failure, purchaser must do its own quality assurance testing appropriate to such applications.