

BIPOLAR ANALOG INTEGRATED CIRCUIT

μ PC8129GR

UP CONVERTER WITH AGC FUNCTION + QUADRATURE MODULATOR IC FOR DIGITAL MOBILE COMMUNICATION SYSTEMS

DESCRIPTION

The μ PC8129GR is a silicon monolithic integrated circuit designed as indirect quadrature modulator for digital mobile communication systems. This modulator consists of 0.8 GHz to 1.9 GHz up-converter and 100 MHz to 400 MHz quadrature modulator which are packaged in 20 pin SSOP. The device has power save function and can operate 2.7 to 5.5 V supply voltage, therefore, it can contribute to make RF block small, high performance and low power consumption.

FEATURES

- High linearity up converter is incorporated; $P_{RFout} = -5$ dBm TYP./@ $f_{RFout} = 900$ MHz
- Wide operating frequency range. Up converter; $f_{RFout} = 800$ MHz to 1900 MHz
Modulator ; $f_{LO1in} = 200$ MHz to 800 MHz
 $f_{MODout} = 100$ MHz to 400 MHz, $f_{I/Q} = DC$ to 10 MHz
- External IF filter can be applied between modulator output and up converter input terminal.
- Low phase difference due to digital phase shifter is adopted.
- Supply voltage: $V_{CC} = 2.7$ to 5.5 V
- Equipped with power save function.
- 20 pin SSOP suitable for high density surface mounting.

APPLICATIONS

- Digital cellular phones (ex. GSM etc...)
- Digital cordless phones

ORDERING INFORMATION

PART NUMBER	PACKAGE	SUPPLYING FORM
μ PC8129GR-E1	20 pin plastic SSOP (225 mil)	Embossed tape 12 mm wide. QTY 2.5 kp/Reel. Pins 1 through 10 are in pull-out direction.

- * To order evaluation samples, please contact your local NEC sales office. (Part number for sample order: μ PC8129GR)

Caution electro-static sensitive device

The information in this document is subject to change without notice. Before using this document, please confirm that this is the latest version.
Not all devices/types available in every country. Please check with local NEC representative for availability and additional information.

INTERNAL BLOCK DIAGRAM AND PIN CONNECTIONS

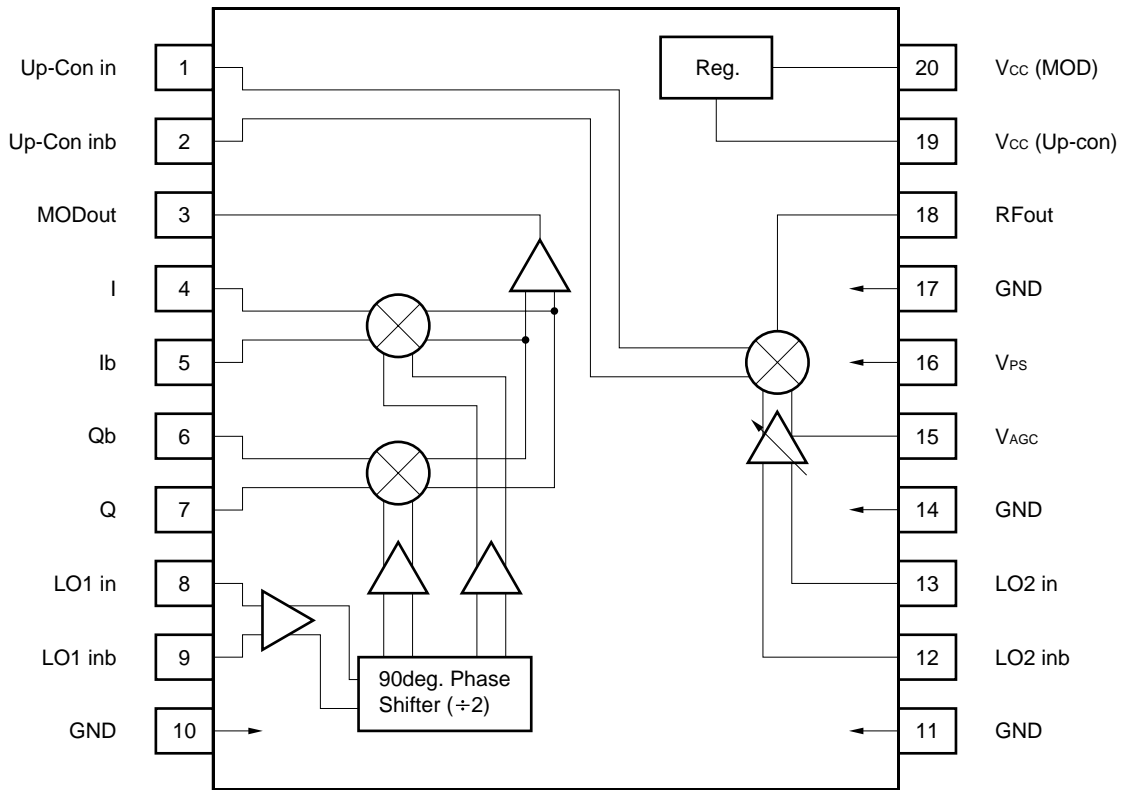

★ QUADRATURE MODULATOR SERIES PRODUCT

Part Number	Functions	I _{cc} (mA)	f _{LOin} (MHz)	f _{MODout} (MHz)	RF Mixer f _{RFout} (MHz)	Phase Shifter	Package	Application
μPC8101GR	150 MHz Quad.Mod	15/@2.7 V	100 to 300	50 to 150	External	F/F	20-pin SSOP (225 mil)	CT-2 etc.
μPC8104GR	RF Up-Converter + IF Quad.Mod	28/@3.0 V	100 to 400	900 to 1 900	External	Doubler + F/F	20-pin SSOP (225 mil)	Digital Comm.
μPC8105GR	400 MHz Quad.Mod	16/@3.0 V	100 to 400					
μPC8110GR	1 GHz Direct Quad.Mod	24/@3.0 V	800 to 1 000					
μPC8125GR	RF Up-Converter + IF Quad.Mod + AGC	36/@3.0 V	220 to 270	1 800 to 2 000				
μPC8126GR	900 MHz Direct Quad.Mod with Offset-Mixer	35/@3.0 V	915 to 960	915 to 960	889 to 960	889 to 960	20-pin SSOP (225 mil)	PDC800 MHz, etc.
μPC8126K			28-pin QFN	PDC800 MHz				
μPC8129GR	×2LO IF Quad. Mod+RF Up-Converter	28/@3.0 V	200 to 800	100 to 400	800 to 1 900	F/F	20-pin SSOP (225 mil)	GSM, DCS1800, etc.
μPC8139GR-7JH	Transceiver IC (1.9 GHz Indirect Quad. Mod + RX-IF + IF VCO)	TX: 32.5 RX: 4.8 /@3.0 V	220 to 270	1 800 to 2 000		CR	30-pin TSSOP (225 mil)	PHS
μPC8158K	RF Up-Converter + IF Quad.Mod + AGC	28/@3.0 V	100 to 300	800 to 1 500			28-pin QFN	PDC800 M/1.5 G

ABSOLUTE MAXIMUM RATINGS

PARAMETER	SYMBOL	RATING	UNIT	CONDITION
Supply Voltage	V _{CC}	6.0	V	T _A = +25 °C
Power Save Voltage	V _{PS}	6.0	V	
AGC Control Voltage	V _{AGC}	6.0	V	
IQ DC Offset Voltage	IQ (DC)	4.0	V	
Power Dissipation	P _D	430	mW	T _A = +85 °C ^{Note}
Operating Ambient Temperature	T _A	-40 to +85	°C	
Storage Temperature	T _{stg}	-55 to +150	°C	

Note Mounted on double sided copper clad 50 × 50 × 1.6 mm epoxy glass PWB.

RECOMMENDED OPERATING CONDITIONS

PARAMETER	SYMBOL	MIN.	TYP.	MAX.	UNIT	CONDITIONS
Supply Voltage	V _{CC}	2.7	3.0	5.5	V	
Operating Ambient Temperature	T _A	-40	+25	+85	°C	
Up Converter RF Frequency	f _{RFout}	800		1900	MHz	
Up Converter Input Freq.	f _{UPCONin}	100		400	MHz	
Modulator Output Frequency	f _{MODout}					
LO1 Input Frequency	f _{LO1in}	200		800	MHz	
LO1 Input Level	P _{LO1in}	-15	-10	-5	dBm	
LO2 Input Frequency	f _{LO2in}	800		1800	MHz	
LO2 Input Level	P _{LO2in}	-15	-10	-5	dBm	
I/Q Input Frequency	f _{I/Qin}	DC		10	MHz	
I/Q Input Amplitude	V _{I/Qin}			600	mV _{P-P}	Single ended Input

ELECTRICAL CHARACTERISTICS (1)

Conditions (unless otherwise specified):

$T_A = +25\text{ }^\circ\text{C}$, $V_{CC} = 3\text{ V}$, $V_{PS} = 3\text{ V}$, $R_{PS} = 1\text{ k}\Omega$, $V_{AGC} = 3\text{ V}$, $R_{AGC} = 10\text{ k}\Omega$

$I/Q\text{ DC} = 1.5\text{ V}$ ($V_{bias(I)} = V_{bias(Ib)} = V_{bias(Q)} = V_{bias(Qb)} = 1.5\text{ V}$)

$f_{I/Qin} = 67.7\text{ kHz}$, $V_{I/Qin} = 500\text{ mV}_{P-P}$ (single ended input, $I_b = Q_b = 0\text{ mV}_{P-P}$)

Modulation Pattern: <0000>

$f_{LO1in} = 500\text{ MHz}$, $P_{LO1in} = -10\text{ dBm}$

$f_{LO2in} = 1150\text{ MHz}$, $P_{LO2in} = -10\text{ dBm}$

$f_{UPCONin} = f_{MODout} = f_{LO1in}/2 + f_{I/Qin} = 250\text{ MHz} + f_{I/Qin}$

$f_{RFout} = 900\text{ MHz} - f_{I/Qin}$

PARAMETER	SYMBOL	MIN.	TYP.	MAX.	UNIT	TEST CONDITIONS
UP CONVERTER + QUADRATURE MODULATOR TOTAL						
Total Circuit Current	$I_{CC(TOTAL)}$	20	28	37	mA	No input signal
Total Circuit Current at Power Save Mode	$I_{CC(PS)TOTAL1}$		0.6	10	μA	$V_{PS} \leq 0.5\text{ V}$
Total Output Power	P_{RFout}	-8	-5	-2	dBm	
Local Oscillator Carrier Leakage	LoL		-40	-26.5	dBc	$f_{LoL} = f_{LO2} - f_{LO1}/2$
Image Rejection (Side Band Leak)	ImR		-30	-26.5	dBc	
AGC Gain Control Rang	GCR	28	40		dB	$V_{AGC} = 2.5\text{ V to }0\text{ V}$
Power Save Rise Time	$T_{PS(rise)}$		2.0	5.0	μs	$V_{PS(Low)} \rightarrow V_{PS(High)}$
Power Save Fall Time	$T_{PS(fall)}$		2.0	5.0	μs	$V_{PS(High)} \rightarrow V_{PS(Low)}$
UP CONVERTER BLOCK						
Circuit Current at Power Save Mode	$I_{CC(PS)}$ (Up con.)			5.0	μA	$V_{PS} \leq 0.5\text{ V}$
QUADRATURE MODULATOR BLOCK						
Circuit Current at Power Save Mode	$I_{CC(PS)}$ (MOD)			5.0	μA	$V_{PS} \leq 0.5\text{ V}$

STANDARD CHARACTERISTICS FOR REFERENCE (1)

Conditions (unless otherwise specified):

$T_A = +25\text{ }^\circ\text{C}$, $V_{CC} = 3\text{ V}$, $V_{PS} = 3\text{ V}$, $R_{PS} = 1\text{ k}\Omega$, $V_{AGC} = 3\text{ V}$, $R_{AGC} = 10\text{ k}\Omega$

I/Q DC = 1.5 V ($V_{bias(I)} = V_{bias(Ib)} = V_{bias(Q)} = V_{bias(Qb)} = 1.5\text{ V}$)

$f_{I/Qin} = 67.7\text{ kHz}$, $P_{I/Qin} = 500\text{ mV}_{P-P}$ (single ended input, $I_b = Q_b = 0\text{ mV}_{P-P}$)

Modulation Pattern: <0000>

$f_{LO1in} = 500\text{ MHz}$, $P_{LO1in} = -10\text{ dBm}$

$f_{LO2in} = 1150\text{ MHz}$, $P_{LO2in} = -10\text{ dBm}$

$f_{UPCONin} = f_{MODout} = f_{LO1in}/2 + f_{I/Qin} = 250\text{ MHz} + f_{I/Qin}$

$f_{RFout} = 900\text{ MHz} - f_{I/Qin}$

PARAMETER	SYMBOL	REFERENCE	UNIT	TEST CONDITIONS
UP CONVERTER + QUADRATURE MODULATOR TOTAL				
Total Circuit Current at Power-Save Mode	$I_{CC(PS)TOTAL2}$	60	μA	$V_{PS} \leq 0.5\text{ V}$, $V_{AGC} = 0\text{ V}$
Phase Error	$\Delta\phi$	1.8	deg. (rms)	MOD Pattern: PN9
UP CONVERTER BLOCK				
UP Con. Circuit Current	$I_{CC(UPCon)}$	14	mA	No input signal
UP Con. Circuit Current at Power-Save Mode	$I_{CC(PS)UPCon}$	60	μA	$V_{PS} \leq 0.5\text{ V}$, $V_{AGC} = 0\text{ V}$
Conversion Gain	CG	12	dB	$P_{UPCONin} = -20\text{ dBm}$
Maximum Output Power	$P_{RF(sat)}$	-1.5	dBm	$P_{UPCONin} = -4\text{ dBm}$
Output 3rd Order Intercept Point	OIP ₃	+6	dBm	$f_{UPCONin} = 250.0\text{ MHz}/250.2\text{ MHz}$
QUADRATURE MODULATOR BLOCK				
MOD. Circuit Current	$I_{CC(MOD)}$	14	mA	No input signal
Output Power	P_{MODout}	-16.5	dBm	
LO1 Carrier Leakage	LoL	-40	dBc	$f_{LoL} = f_{LO1}/2$
Image Rejection (Side Band Leak)	ImR	-30	dBc	
I/Q 3rd Order Intermodulation Distortion	IM _{3/IQ}	-50	dBc	
I/Q Input Impedance	$Z_{I/Q}$	200	kΩ	I to Ib, Q to Qb
IQ Bias Current	$I_{I/Q}$	5	μA	I, Ib, Q, Qb to GND (each)
LO1 Input VSWR	$VSWR_{(Lo1)}$	1.2 : 1	-	
Output Noise Floor		-133	dBc/Hz	$\Delta f = \pm 20\text{ MHz}$

STANDARD CHARACTERISTICS FOR REFERENCE (2)

Conditions (unless otherwise specified):

$T_A = +25\text{ }^\circ\text{C}$, $V_{CC} = 3\text{ V}$, $V_{PS} = 3\text{ V}$, $R_{PS} = 1\text{ k}\Omega$, $V_{AGC} = 3\text{ V}$, $R_{AGC} = 10\text{ k}\Omega$

I/Q DC = 1.5 V ($V_{bias(I)} = V_{bias(Ib)} = V_{bias(Q)} = V_{bias(Qb)} = 1.5\text{ V}$)

$f_{I/Qin} = 67.7\text{ kHz}$, $P_{I/Qin} = 500\text{ mV}_{P-P}$ (single ended input, $I_b = Q_b = 0\text{ mV}_{P-P}$)

Modulation Pattern: <0000>

$f_{LO1in} = 500\text{ MHz}$, $P_{LO1in} = -10\text{ dBm}$

$f_{LO2in} = 1650\text{ MHz}$, $P_{LO2in} = -10\text{ dBm}$

$f_{UPCONin} = f_{MODout} = f_{LO1in}/2 + f_{I/Qin} = 250\text{ MHz} + f_{I/Qin}$

$f_{RFout} = 1900\text{ MHz} + f_{I/Qin}$

PARAMETER	SYMBOL	REFERENCE	UNIT	TEST CONDITIONS
UP CONVERTER + QUADRATURE MODULATOR TOTAL				
Total Output Power	P_{RFout}	-12	dBm	
Local Oscillator Carrier Leakage	LoL	-40	dBc	$f_{LoL} = f_{LO2} + f_{LO1}/2$
Image Rejection (Side Band Leak)	ImR	-30	dBc	
AGC Gain Control Rang	GCR	45	dB	$V_{AGC} = 2.5\text{ V to }0\text{ V}$
Phase Error	$\Delta\phi$	1.8	deg. (rms)	MOD Pattern: PN9
UP CONVERTER BLOCK				
Conversion Gain	CG	5	dB	$P_{UPCONin} = -20\text{ dBm}$
Maximum Output Power	$P_{RF(sat)}$	-7	dBm	$P_{UPCONin} = -4\text{ dBm}$
Output Intercept Point	OIP ₃	-1	dBm	$f_{UPCONin} = 250.0\text{ MHz}/250.2\text{ MHz}$

PIN EXPLANATION

Pin No.	Symbol	Supply Voltage (V)	Pin Voltage Typ. (V) @V _{CC} = 3 V	Description	Equivalent Circuit
18	RFout	V _{CC}	–	RF output from Up-Converter. This pin is open collector output.	
1	UpCon in	–	2.2	IF input for Up-converter. This pin is high impedance input.	
2	UpCon inb	–	2.2	Bypass of IF input. Grounded through external capacitor.	
3	MODout	–	1.9	Output from modulator. This is emitter follower output.	
4	I	V _{CC} /2	–	Input for I signal. This input impedance is about 200 kΩ. Relations between amplitude and V _{CC} /2 bias of input signal are following.	
5	Ib	V _{CC} /2	–	Input for I signal. This input impedance is about 200 kΩ. V _{CC} /2 biased DC signal should be input.	
6	Qb	V _{CC} /2	–	Input for Q signal. This input impedance is about 200 kΩ. V _{CC} /2 biased DC signal should be input.	
7	Q	V _{CC} /2	–	Input for Q signal. This input impedance is about 200 kΩ. Relations between amplitude and V _{CC} /2 bias of input signal are following.	

V _{CC} /2 (V)	Signal Level (mV _{P-P})	Note
≥ 1.35	≤ 400	
≥ 1.5	≤ 600	
≥ 1.75	≤ 1000	

V _{CC} /2 (V)	Signal Level (mV _{P-P})	Note
≥ 1.35	≤ 400	
≥ 1.5	≤ 600	
≥ 1.75	≤ 1000	

Note In the case of that I/Q input signals are single ended.
Of course, I/Q signal inputs can be used either single endedly or differentially with proper terminations.

PIN EXPLANATION

Pin No.	Symbol	Supply Voltage (V)	Pin Voltage Typ. (V) @ V _{CC} = 3 V	Description	Equivalent Circuit						
8	LO1in	–	0	Lo1 input for phase shifter. This input impedance is 50 Ω matched internally.							
9	LO1in b	–	2.3	Bypass of Lo1 input. This pin is grounded through internal capacitor.							
10	GND for Modulator	0	–	Connect to the ground with minimum inductance. Track length should be kept as short as possible.							
11											
12	LO2in b	–	1.9	Bypass of Lo2 input. Grounded through external capacitor.							
13	LO2in	–	1.9	Lo2 input of Up-converter. This pin is high impedance input.							
14	GND for Up-con.	0	–	Connect to the ground with minimum inductance. Track length should be kept as short as possible.							
17											
15	V _{AGC}	0 to V _{CC}	–	Input for AGC amplifier. Total Output Power can be controlled by changing input voltage. And as external series resistance (R _{AGC}) connecting, a slope of AGC curve can be changed by the resistance (R _{AGC}).							
16	Power Save	0 to V _{CC}	–	Power save control pin can be controlled ON/OFF state with bias as follows; <table border="1" style="margin: 10px auto;"> <thead> <tr> <th>V_{PS} (V)</th> <th>STATE</th> </tr> </thead> <tbody> <tr> <td>2 to V_{CC}</td> <td>ON (Active Mode)</td> </tr> <tr> <td>0 to 0.5</td> <td>OFF (Sleep Mode)</td> </tr> </tbody> </table>	V _{PS} (V)	STATE	2 to V _{CC}	ON (Active Mode)	0 to 0.5	OFF (Sleep Mode)	
V _{PS} (V)	STATE										
2 to V _{CC}	ON (Active Mode)										
0 to 0.5	OFF (Sleep Mode)										
19	V _{CC} for Up-converter	2.7 to 5.5	–	Supply voltage pin for Up-converter.							
20	V _{CC} for Modulator	2.7 to 5.5	–	Supply voltage pin for modulator. Internal regulator can be kept stable condition of supply bias against the variable temperature or V _{CC} .							

: Externally

STANDARD TYPICAL CHARACTERISTICS <Modulator + Up-Converter Total at 900 MHz>

Test Circuit 1, $T_A = +25\text{ }^\circ\text{C}$, $V_{CC} = 3\text{ V}$, $V_{PS} = 3\text{ V}$, $R_{PS} = 1\text{ k}\Omega$, $V_{AGC} = 3\text{ V}$, $R_{AGC} = 10\text{ k}\Omega$

I/Q DC = 1.5 V ($V_{bias(I)} = V_{bias(Ib)} = V_{bias(Q)} = V_{bias(Qb)} = 1.5\text{ V}$)

$f_{I/Qin} = 67.7\text{ kHz}$, $V_{I/Qin} = 500\text{ mV}_{P-P}$ (single ended input, $I_b = Q_b = 0\text{ mV}_{P-P}$)

Modulation Pattern: All Zero <0000>, $f_{LO1in} = 500\text{ MHz}$, $P_{LO1in} = -10\text{ dBm}$

$f_{LO2in} = 1150\text{ MHz}$, $P_{LO2in} = -10\text{ dBm}$, $f_{UPCONin} = f_{MODout} = f_{LO1in}/2 + f_{I/Qin} = 250\text{ MHz} + f_{I/Qin}$

$f_{RFout} = 900\text{ MHz} - f_{I/Qin}$, Unless Otherwise Specified

I_{CC} (TOTAL) vs V_{CC}

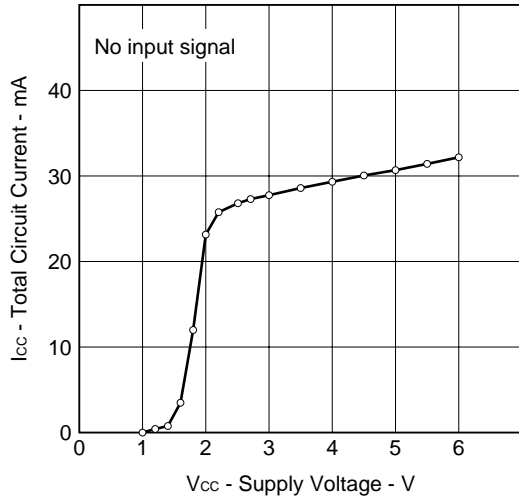

I_{CC} (TOTAL) vs V_{PS}

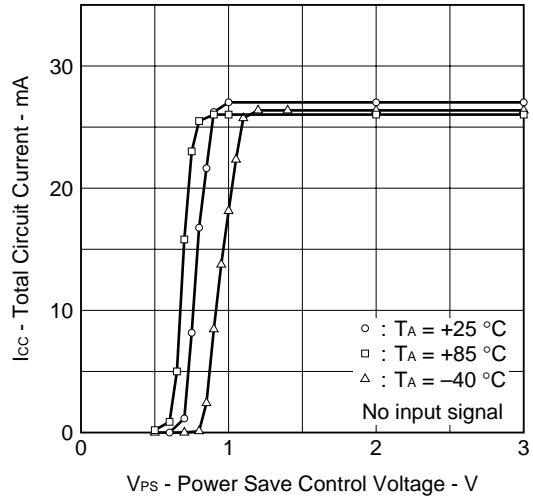

I_{CC} (TOTAL) vs T_A

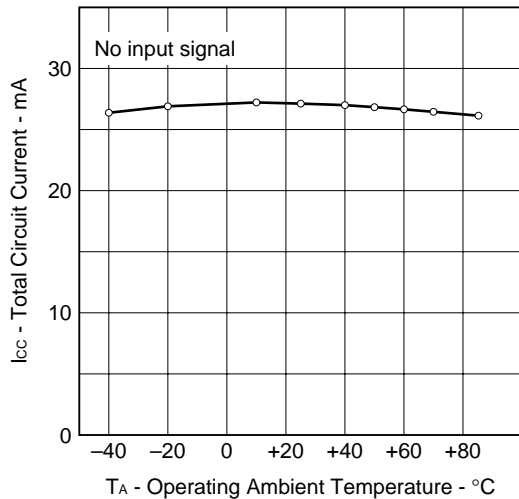

I_{CC} (PS) TOTAL vs T_A

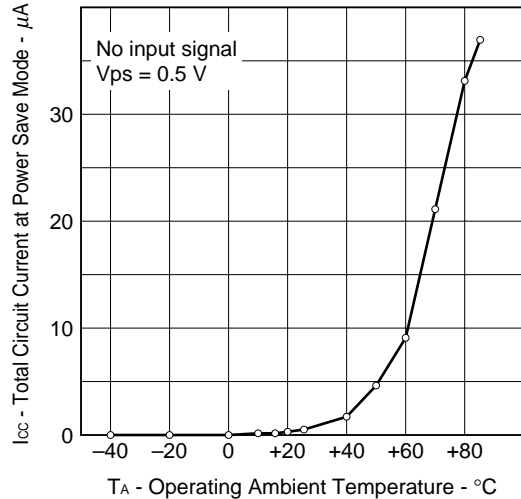

I_{CC} (PS) TOTAL2 vs T_A

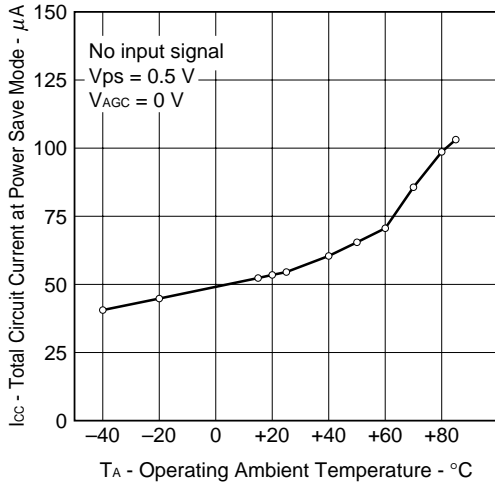

I_{CC} (PS) TOTAL1 vs V_{CC}

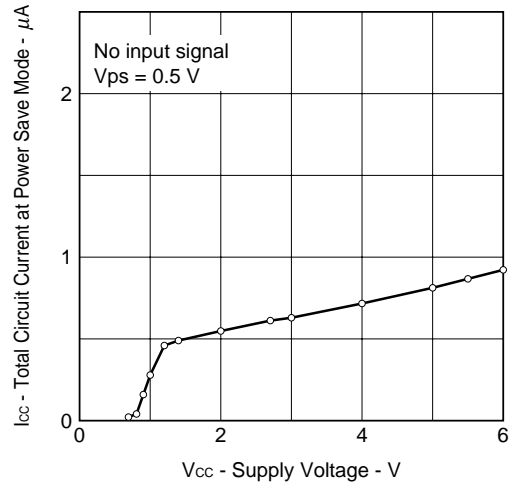

I_{CC} (PS) TOTAL2 vs V_{CC}

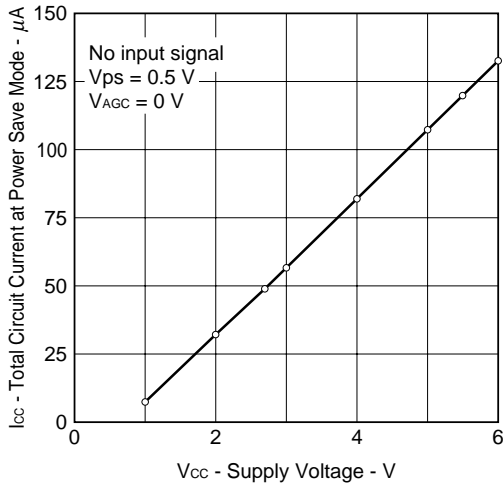

P_{RFout}, LoL, ImR, IM_{3/Q} vs V_{CC}

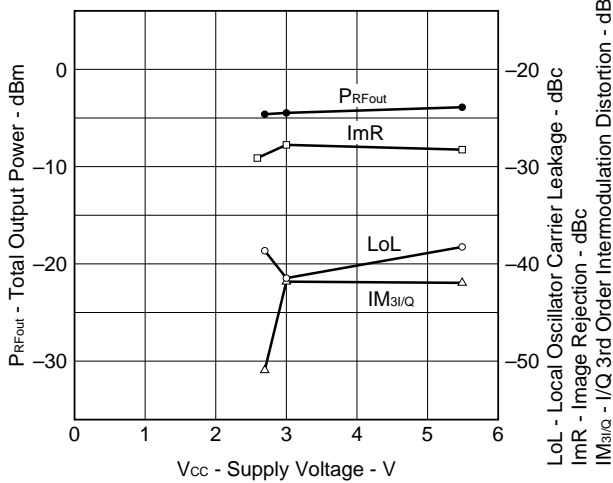

P_{RFout}, LoL, ImR, IM_{3/Q} vs T_A

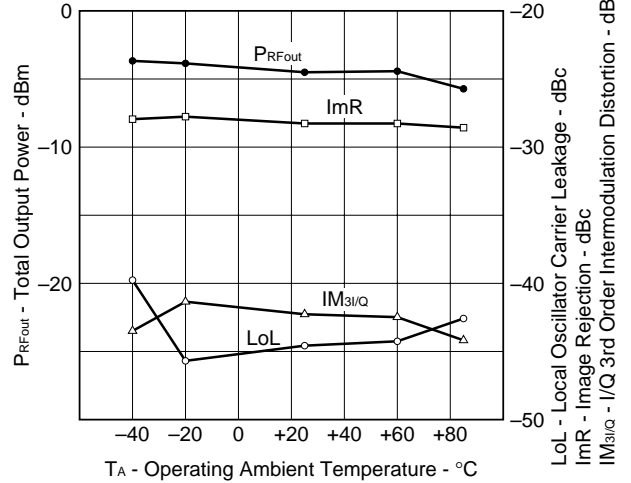

P_{RFout}, LoL, ImR, IM_{3/IQ} vs V_{I/Qin}

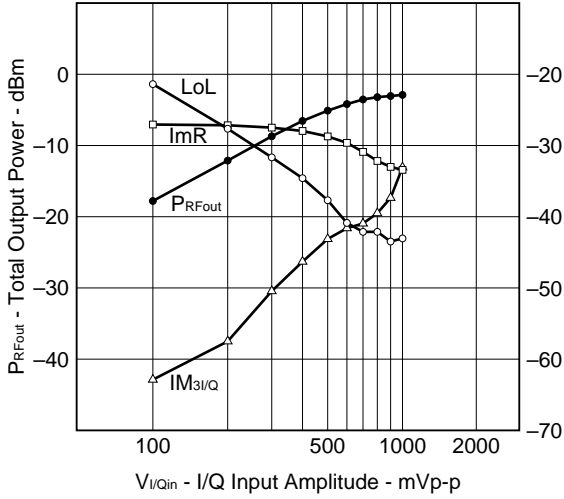

P_{RFout}, LoL, ImR, IM_{3/IQ} vs P_{LO1in}

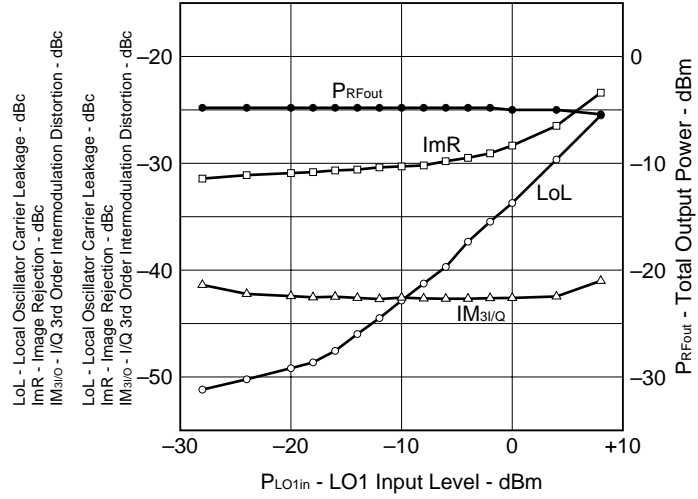

P_{RFout} vs P_{LO2in}

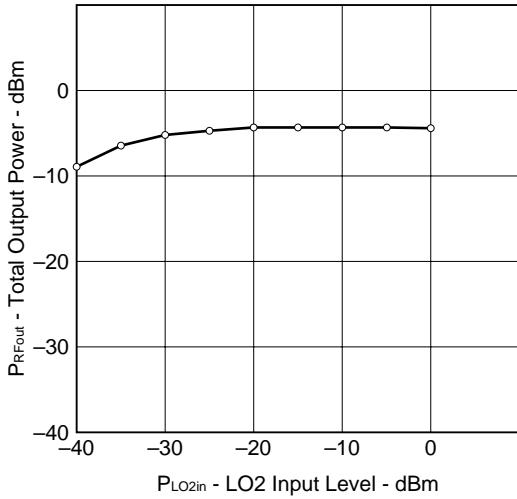

ΔΦ vs V_{I/Qin}

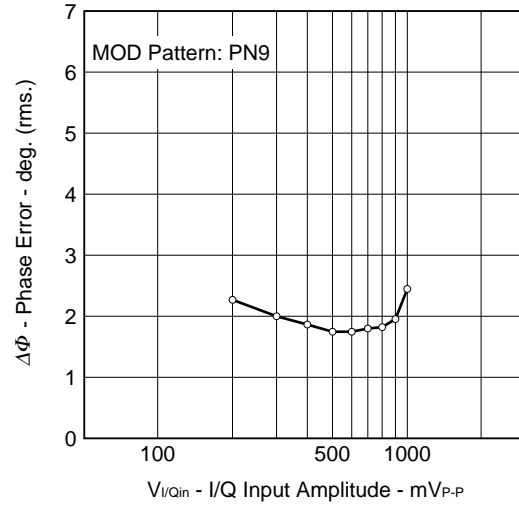

P_{RFout} vs V_{AGC}

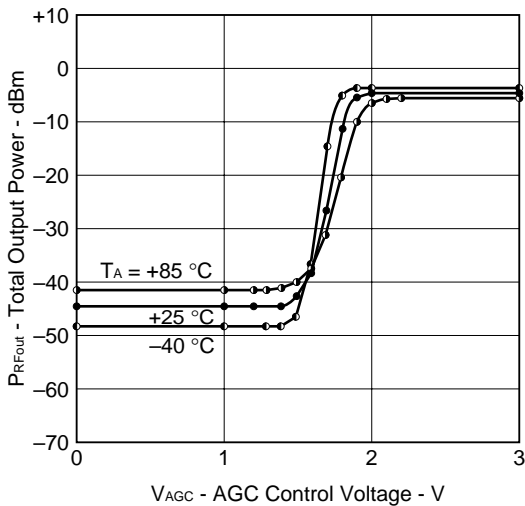

P_{RFout} vs V_{AGC}

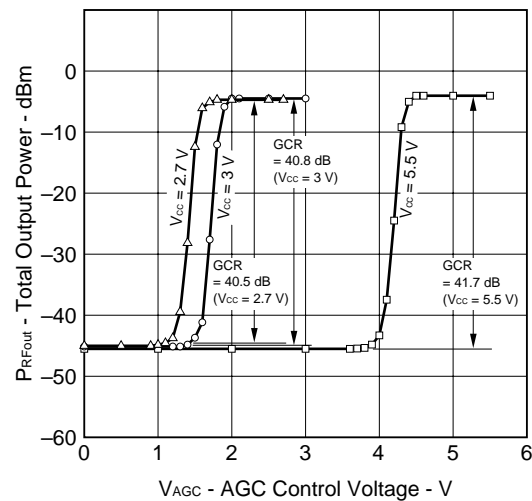

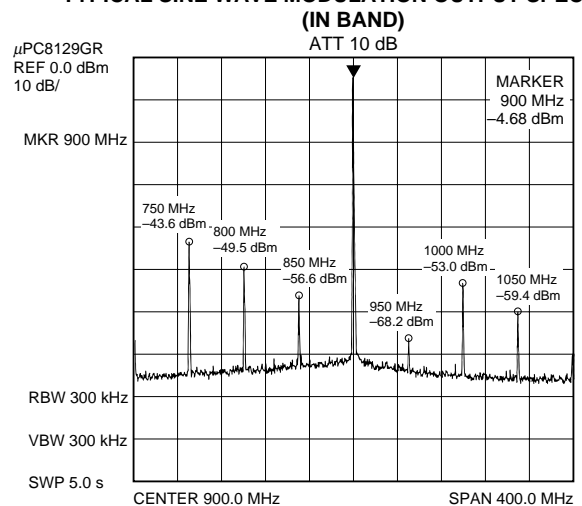
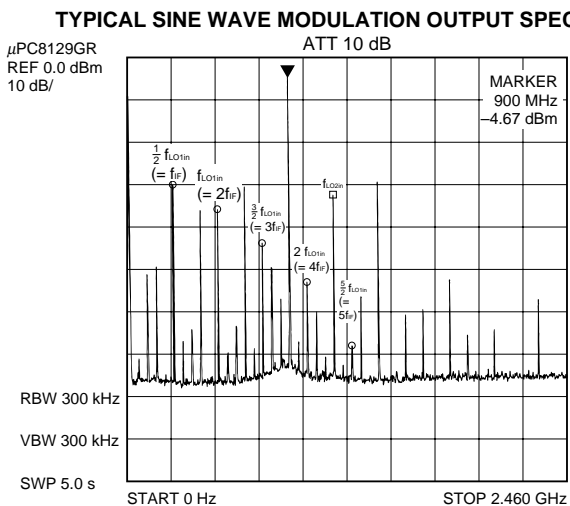
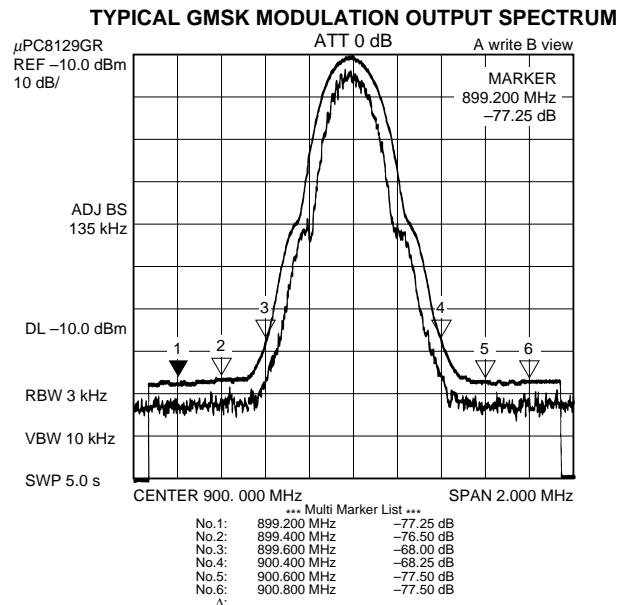
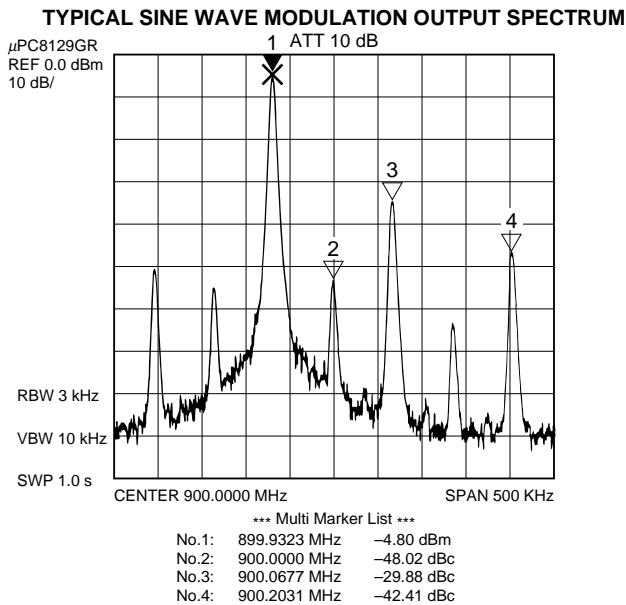
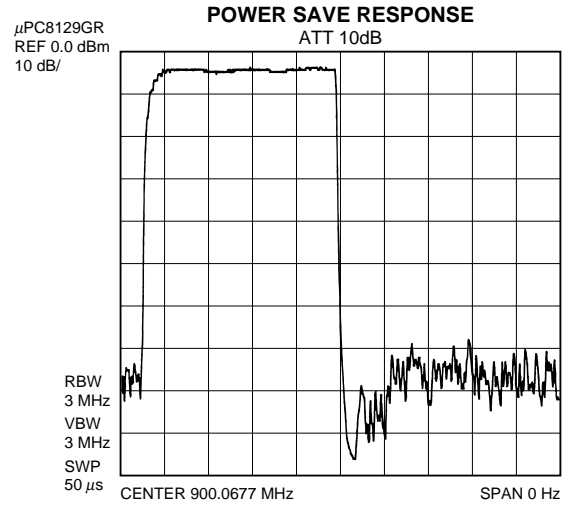
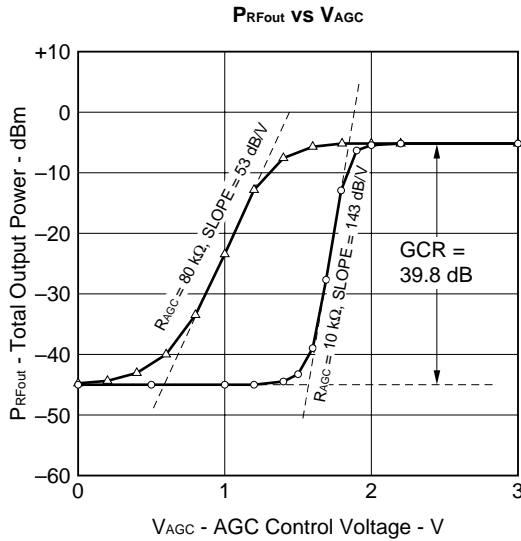

TYPICAL SINE WAVE MODULATION OUTPUT SPECTRUM

(IN BAND)
ATT 10 dB

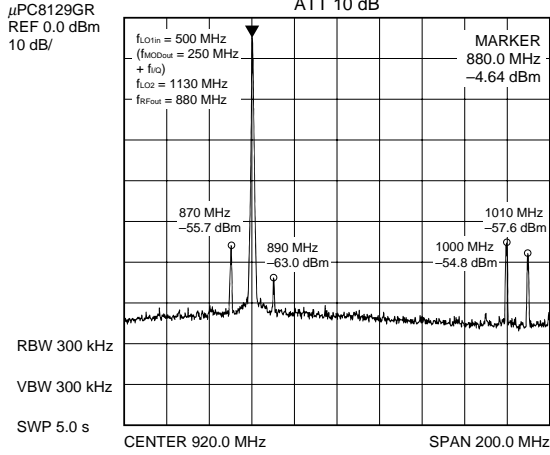

TYPICAL SINE WAVE MODULATION OUTPUT SPECTRUM

(IN BAND)
ATT 10 dB

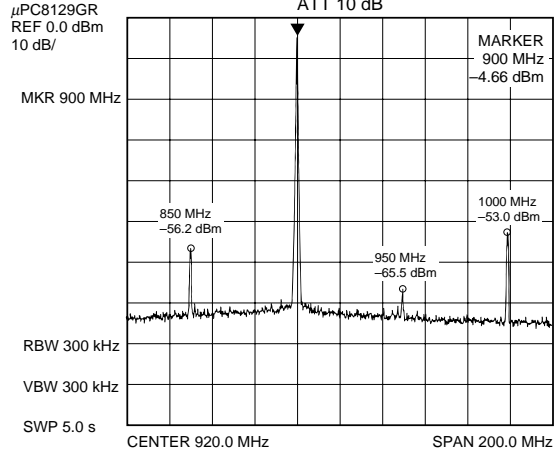

TYPICAL SINE WAVE MODULATION OUTPUT SPECTRUM

(IN BAND)
ATT 10 dB

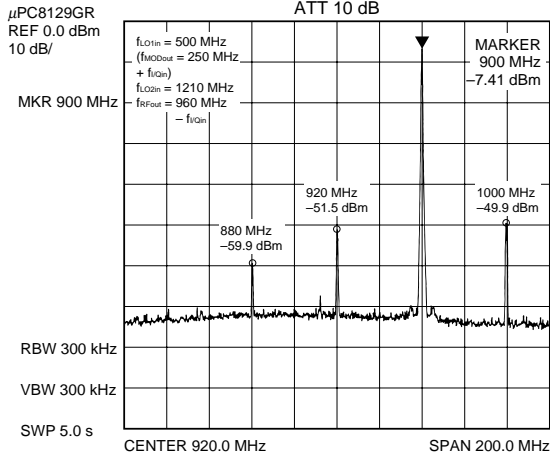

STANDARD TYPICAL CHARACTERISTICS <Modulator + Up-Converter Total at 1900 MHz>

Test Circuit 2, $T_A = +25\text{ }^\circ\text{C}$, $V_{CC} = 3\text{ V}$, $V_{PS} = 3\text{ V}$, $R_{PS} = 1\text{ k}\Omega$, $V_{AGC} = 3\text{ V}$, $R_{AGC} = 10\text{ k}\Omega$

I/Q DC = 1.5 V ($V_{bias(I)} = V_{bias(Ib)} = V_{bias(Q)} = V_{bias(Qb)} = 1.5\text{ V}$)

$f_{I/Qin} = 67.7\text{ kHz}$, $V_{I/Qin} = 500\text{ mV}_{P-P}$ (single ended input, $I_b = Q_b = 0\text{ mV}_{P-P}$)

Modulation Pattern: All Zero <0000>, $f_{LO1in} = 500\text{ MHz}$, $P_{LO1in} = -10\text{ dBm}$

$f_{LO2in} = 500\text{ MHz}$, $P_{LO2in} = -10\text{ dBm}$, $f_{UPCONin} = f_{MODout} = f_{LO1in}/2 + f_{I/Qin} = 250\text{ MHz} + f_{I/Qin}$

$f_{RFout} = 1900\text{ MHz} + f_{I/Qin}$, Unless Otherwise Specified

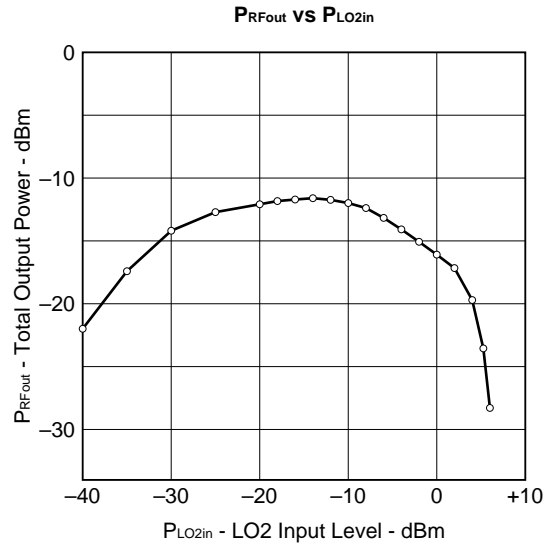
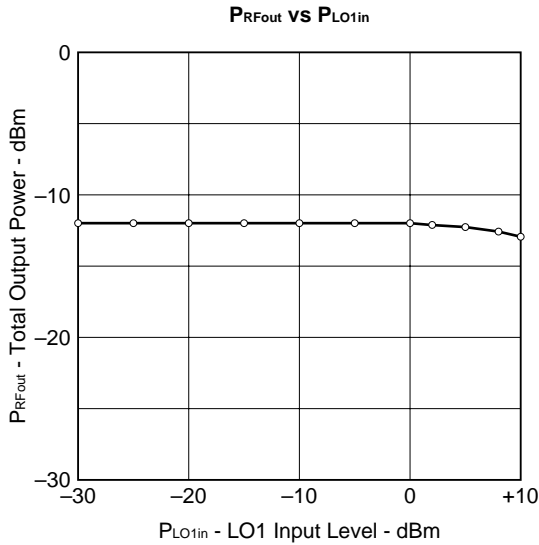
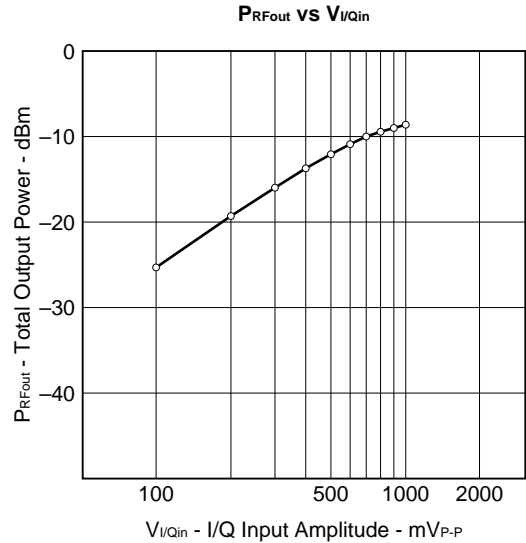
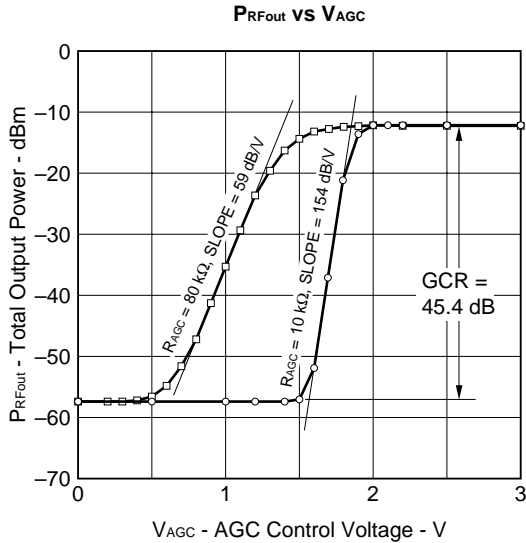

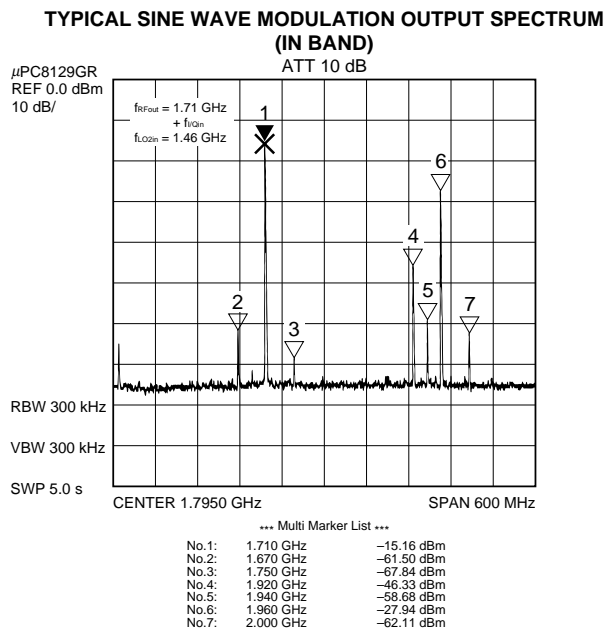
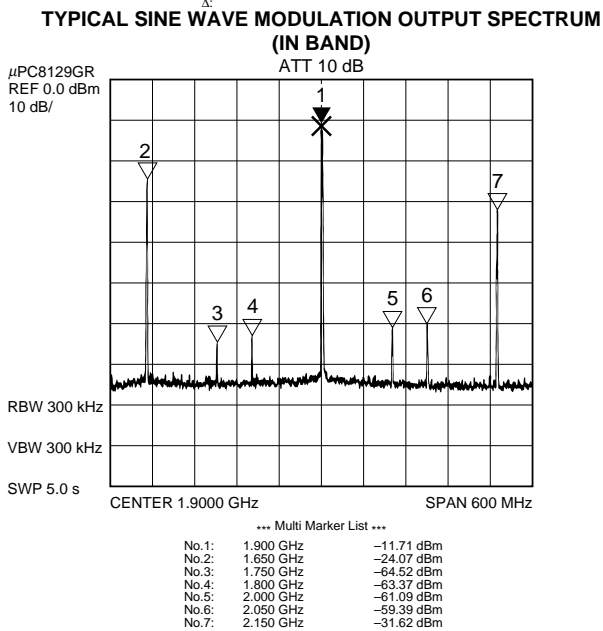
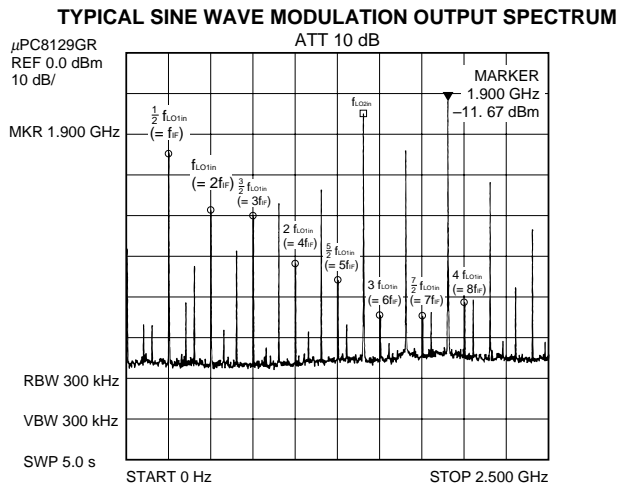
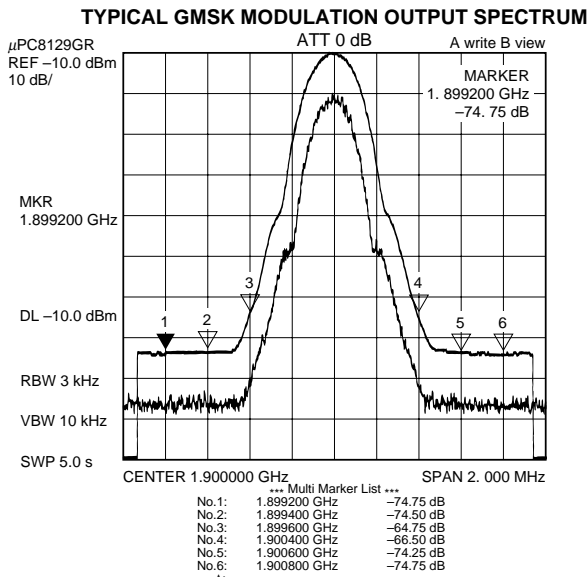
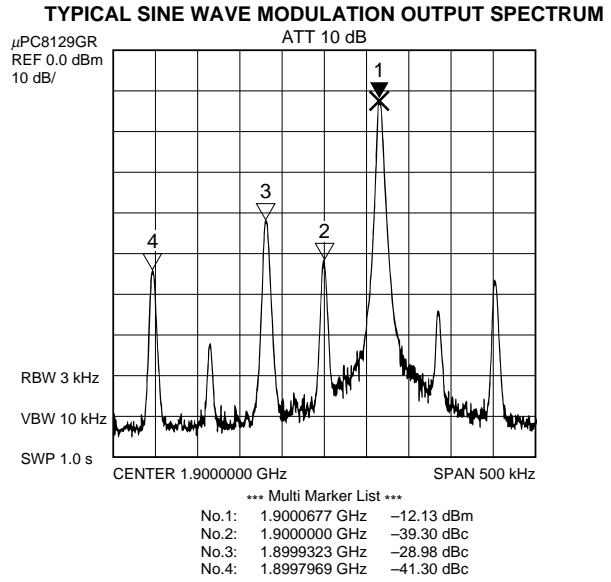
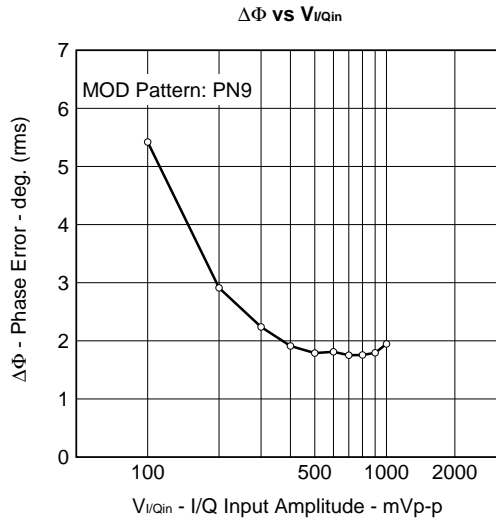

TYPICAL SINE WAVE MODULATION OUTPUT SPECTRUM
(IN BAND)

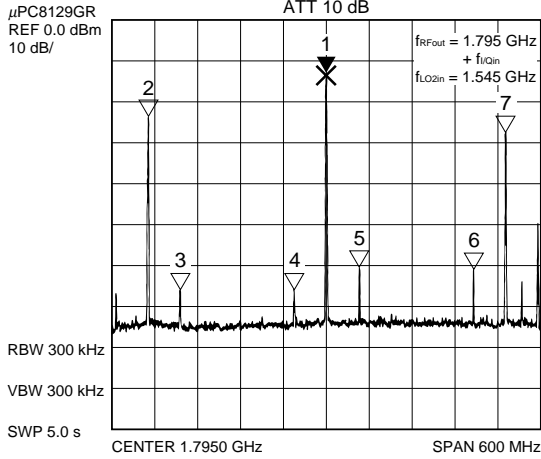

*** Multi Marker List ***

No.1:	1.795 GHz	-14.21 dBm
No.2:	1.545 GHz	-24.47 dBm
No.3:	1.590 GHz	-65.96 dBm
No.4:	1.750 GHz	-66.40 dBm
No.5:	1.840 GHz	-60.91 dBm
No.6:	2.000 GHz	-61.79 dBm
No.7:	2.045 GHz	-28.73 dBm

TYPICAL SINE WAVE MODULATION OUTPUT SPECTRUM
(IN BAND)

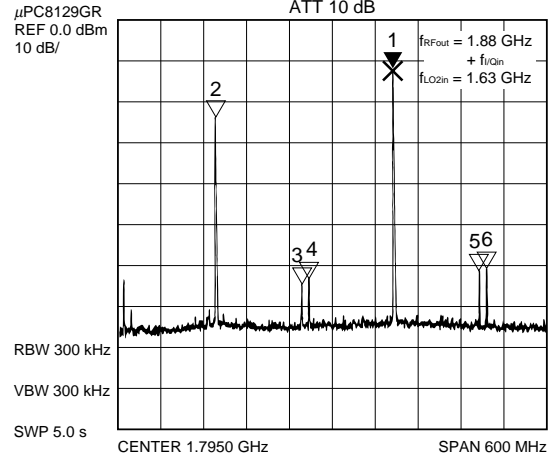

*** Multi Marker List ***

No.1:	1.880 GHz	-12.32 dBm
No.2:	1.630 GHz	-23.47 dBm
No.3:	1.750 GHz	-64.08 dBm
No.4:	1.760 GHz	-63.19 dBm
No.5:	2.000 GHz	-61.05 dBm
No.6:	2.010 GHz	-60.25 dBm

STANDARD TYPICAL CHARACTERISTICS <Up-Converter Block>

$T_A = +25\text{ }^\circ\text{C}$, $V_{CC} = 3.0\text{ V}$, $V_{PS} = 3.0\text{ V}$, $f_{UPCONin} = 250\text{ MHz}$, $P_{UPCONin} = -20\text{ dBm}$

Test Circuit 1 ($f_{RFout} = 900\text{ MHz}$, $f_{LO2in} = 1150\text{ MHz}$) or

Test Circuit 2 ($f_{RFout} = 1900\text{ MHz}$, $f_{LO2in} = 1650\text{ MHz}$), Unless Otherwise Specified

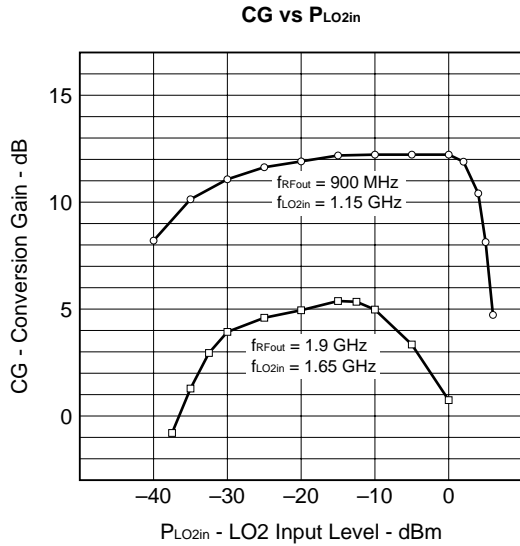
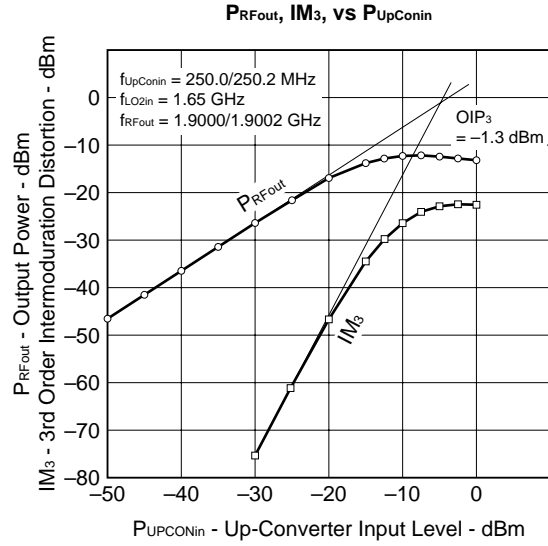
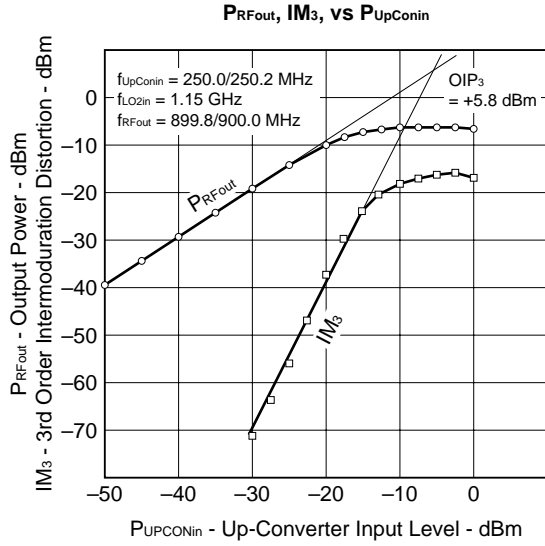

STANDARD TYPICAL CHARACTERISTICS <Modulator Block>

Test Circuit 1 or 2, $T_A = +25\text{ }^\circ\text{C}$, $V_{CC} = 3\text{ V}$, $V_{PS} = 3\text{ V}$

I/Q DC = 1.5 V ($V_{bias(I)} = V_{bias(Ib)} = V_{bias(Q)} = V_{bias(Qb)} = 1.5\text{ V}$)

$f_{I/Qin} = 67.7\text{ kHz}$, $V_{I/Qin} = 500\text{ mV}_{P-P}$ (single ended input, $I_b = Q_b = 0\text{ mV}_{P-P}$)

Modulation Pattern: All Zero <0000>, $f_{LO1in} = 500\text{ MHz}$, $P_{LO1in} = -10\text{ dBm}$

$f_{MODout} = f_{LO1in}/2 + f_{I/Qin} = 250\text{ MHz} + f_{I/Qin}$, Unless Otherwise Specified

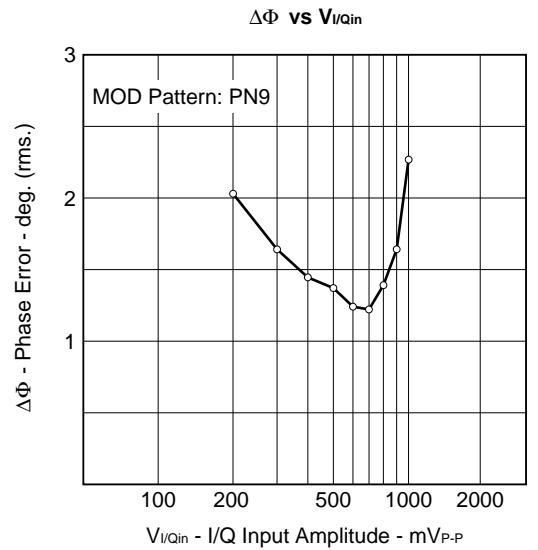
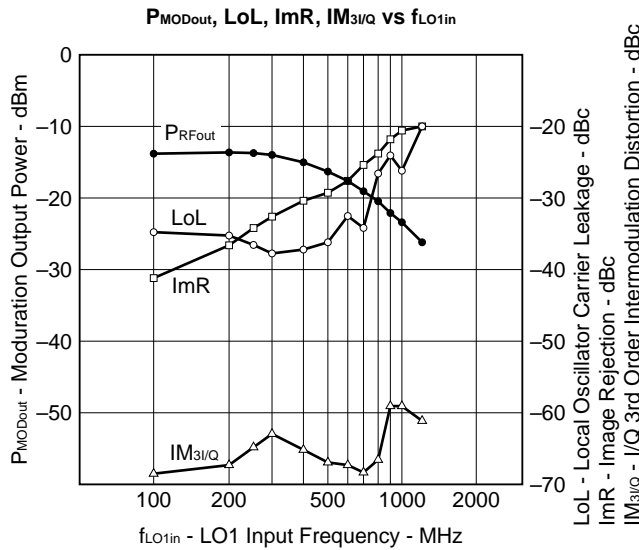
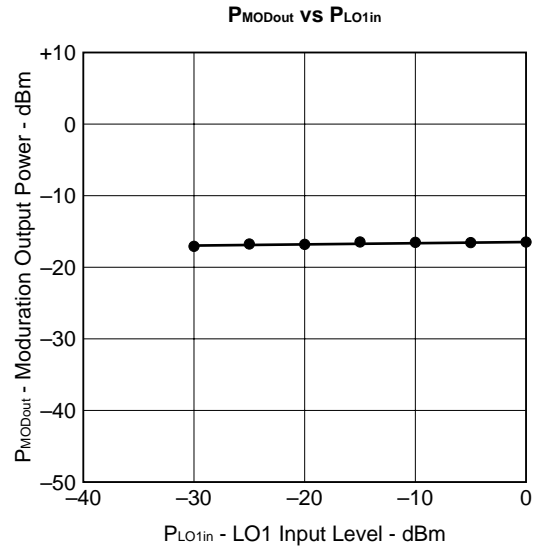
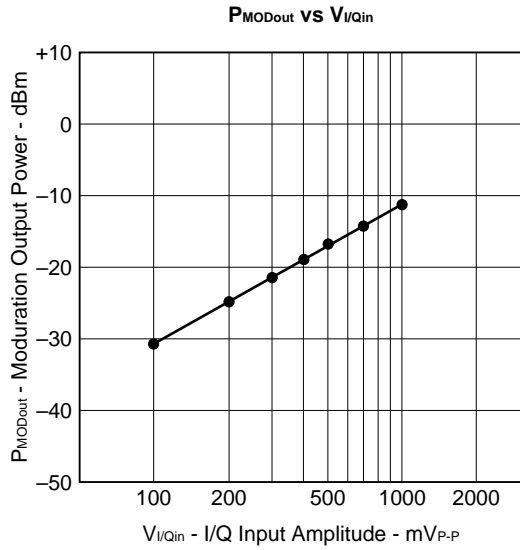

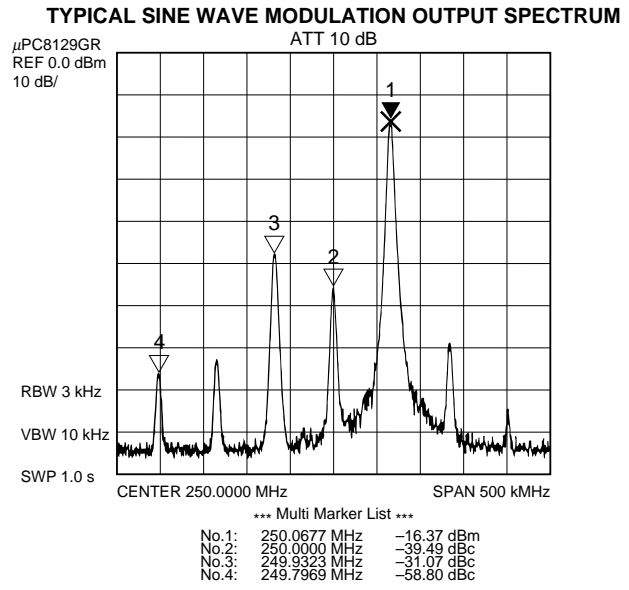
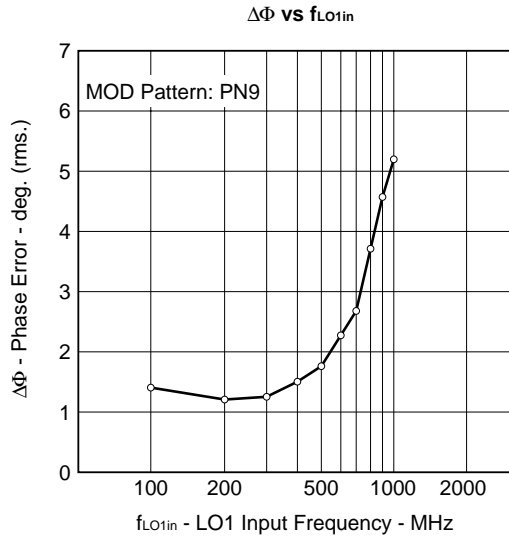

LO1 INPUT (Pin8) IMPEDANCE

$V_{CC} = V_{PS} = 3\text{ V}$

CH1 S₁₁ 1 U FS 2: 47.998 Ω 0.8066 Ω 256.76 pH
500.000 000 MHz
MARKER 2
500 MHz

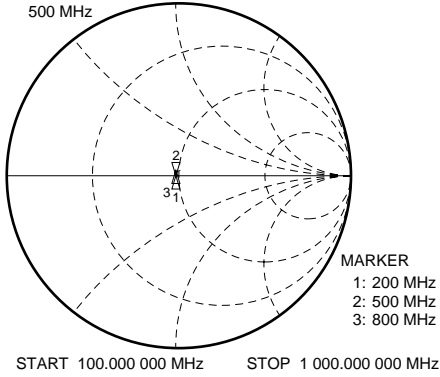

MOD OUTPUT (Pin3) IMPEDANCE

$V_{CC} = V_{PS} = 3\text{ V}$

CH1 S₂₂ 1 U FS 2: 31.195 Ω 14.908 Ω 9.4909 nH
250.000 000 MHz
MARKER 2
250 MHz

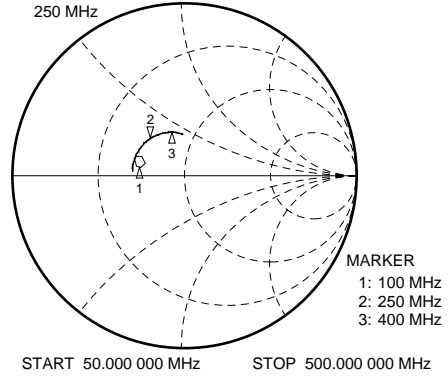

Up-Con. INPUT (Pin1) IMPEDANCE

$V_{CC} = V_{PS} = 3\text{ V}$

CH1 S₁₁ 1 U FS 2: 101.78 Ω -387.03 Ω 1.6449 pF
250.000 000 MHz
MARKER 2
250 MHz

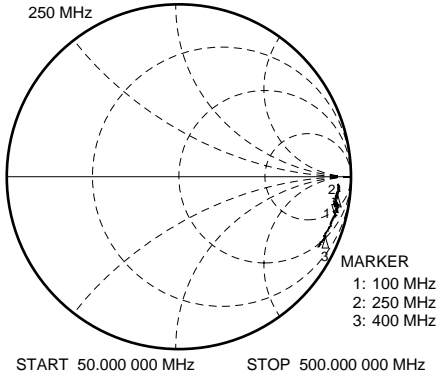

LO2 INPUT (Pin13) IMPEDANCE

$V_{CC} = V_{PS} = 3\text{ V}$

CH1 S₁₁ 1 U FS 1: 22.379 Ω -93.543 Ω 1.8905 pF
900.000 000 MHz
MARKER 1
900 MHz

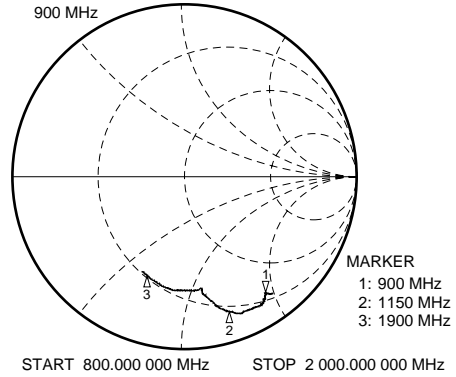

RF OUTPUT (Pin18) IMPEDANCE

$V_{CC} = V_{PS} = 3\text{ V}$

CH1 S₂₂ 1 U FS 1: 18.953 Ω -158.83 Ω 1.1134 pF
900.000 000 MHz
MARKER 1
900 MHz

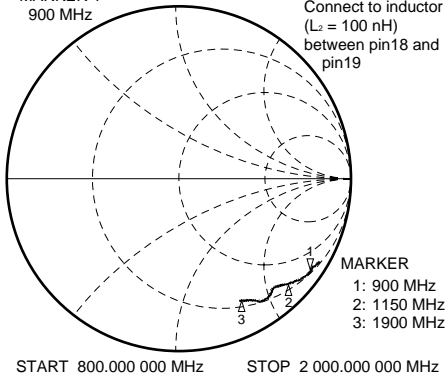

TEST CIRCUIT 1 (In the case of $f_{RFout} = 900$ MHz Band)

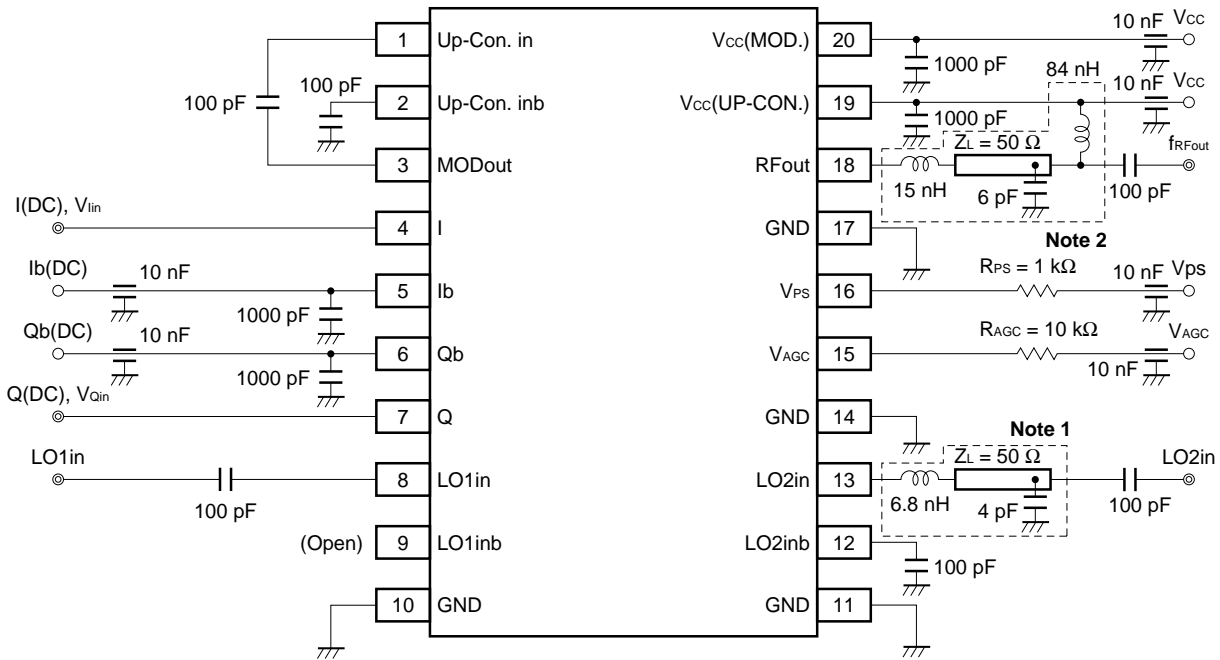

- Notes 1.** 50 Ω matching circuit at $f_{LO2in} = 1150$ MHz.
 In the case of using NEC's evaluation board.
- 2.** 50 Ω matching circuit at $f_{RFout} = 900$ MHz.
 In the case of using NEC's evaluation board.

TEST CIRCUIT 2 (In the case of $f_{RFout} = 1900$ MHz Band)

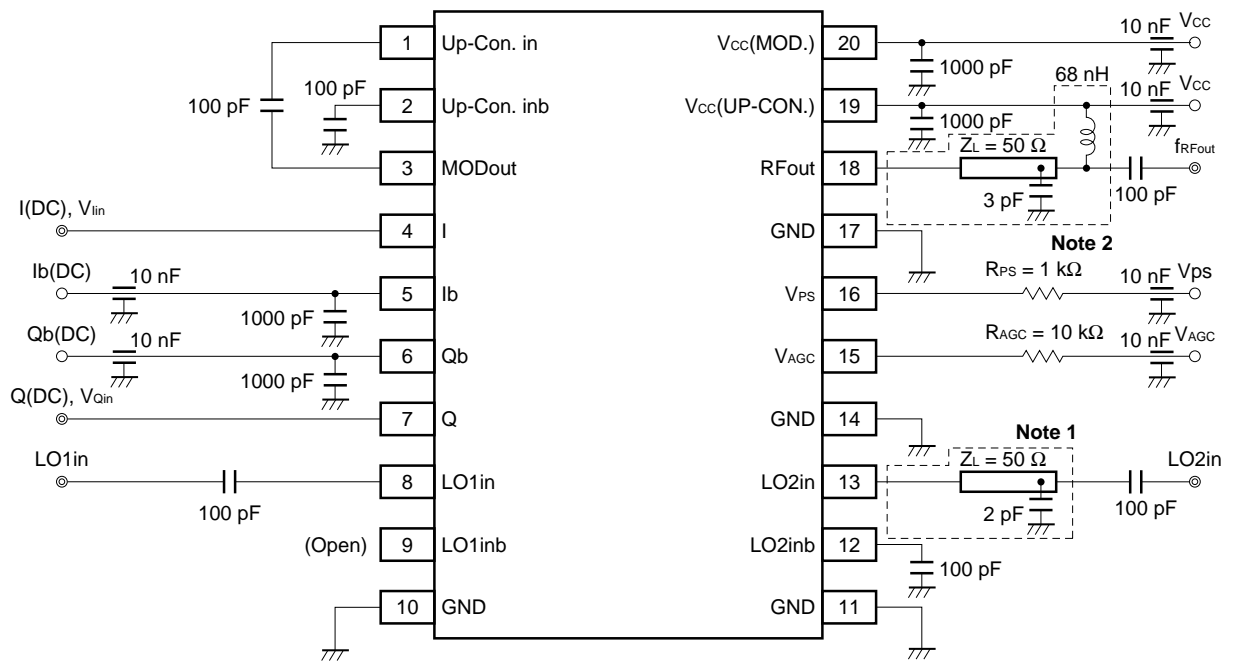

- Notes 1.** 50 Ω matching circuit at $f_{LO2in} = 1650$ MHz.
 In the case of using NEC's evaluation board.
- 2.** 50 Ω matching circuit at $f_{RFout} = 1900$ MHz.
 In the case of using NEC's evaluation board.

PACKAGE DIMENSIONS

★ 20 PIN PLASTIC SSOP (225 mil) (UNIT: mm)

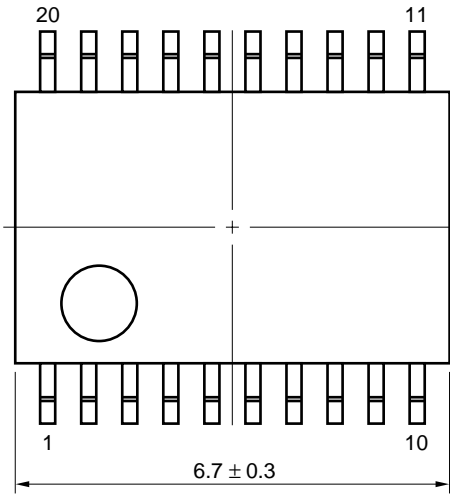

detail of lead end

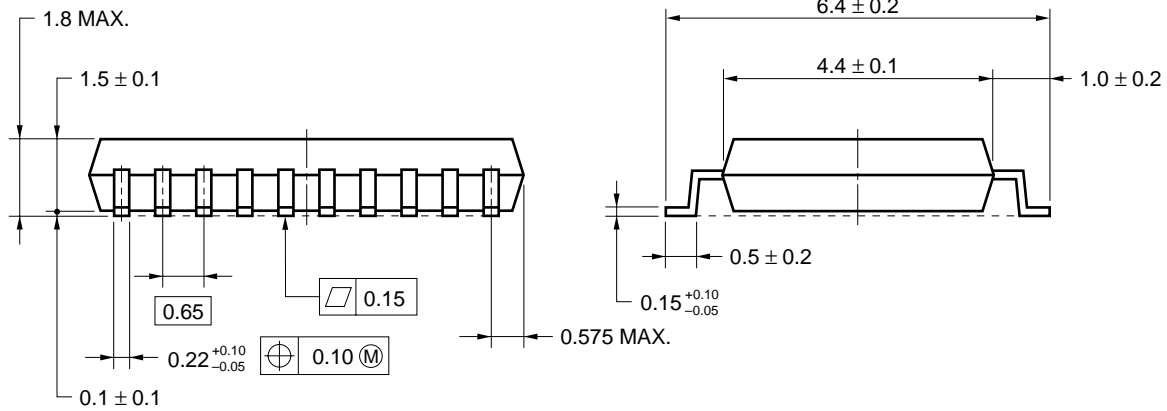
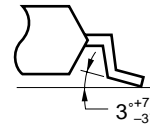

NOTE Each lead centerline is located within 0.10 mm of its true position (T.P.) at maximum material condition.

NOTE ON CORRECT USE

- (1) Observe precautions for handling because of electrostatic sensitive devices.
- (2) Form a ground pattern as widely as possible to minimize ground impedance (to prevent undesired oscillation).
- (3) Keep the track length of the ground pins as short as possible.
- (4) Connect a bypass capacitor (e.x. 1000 pF) to the Vcc pin.

RECOMMENDED SOLDERING CONDITIONS

This product should be soldered in the following recommended conditions. Other soldering method and conditions than the recommended conditions are to be consulted with sales representatives.

μPC8129GR

Soldering process	Soldering conditions	Symbol
Infrared ray reflow	Peak package's surface temperature: 235 °C or below, Reflow time: 30 seconds or below (210 °C or higher) Number of reflow process: 2, Exposure limit ^{Note} : None	IR35-00-2
VPS	Peak package's surface temperature: 215 °C or below, Reflow time: 40 seconds or below (200 °C or higher) Number of reflow process: 2, Exposure limit ^{Note} : None	VP15-00-2
Wave soldering	Solder temperature: 260 °C or below, Flow time: 10 seconds or below, Number of flow process: 1, Exposure limit ^{Note} : None	WS60-00-1
Partial heating method	Terminal temperature: 300 °C or below, Flow time: 3 seconds/pin or below, Exposure limit ^{Note} : None	

Note Exposure limit before soldering after dry-pack package is opened.
Storage conditions: 25 °C and relative humidity at 65 % or less.

Caution Apply only a single process at once, except for “Partial heating method”.
For details of recommended soldering conditions for surface mounting, refer to information document SEMICONDUCTOR DEVICE MOUNTING TECHNOLOGY MANUAL (C10535E).

- **The information in this document is subject to change without notice. Before using this document, please confirm that this is the latest version.**
 - No part of this document may be copied or reproduced in any form or by any means without the prior written consent of NEC Corporation. NEC Corporation assumes no responsibility for any errors which may appear in this document.
 - NEC Corporation does not assume any liability for infringement of patents, copyrights or other intellectual property rights of third parties by or arising from use of a device described herein or any other liability arising from use of such device. No license, either express, implied or otherwise, is granted under any patents, copyrights or other intellectual property rights of NEC Corporation or others.
 - Descriptions of circuits, software, and other related information in this document are provided for illustrative purposes in semiconductor product operation and application examples. The incorporation of these circuits, software, and information in the design of the customer's equipment shall be done under the full responsibility of the customer. NEC Corporation assumes no responsibility for any losses incurred by the customer or third parties arising from the use of these circuits, software, and information.
 - While NEC Corporation has been making continuous effort to enhance the reliability of its semiconductor devices, the possibility of defects cannot be eliminated entirely. To minimize risks of damage or injury to persons or property arising from a defect in an NEC semiconductor device, customers must incorporate sufficient safety measures in its design, such as redundancy, fire-containment, and anti-failure features.
 - NEC devices are classified into the following three quality grades:
"Standard", "Special", and "Specific". The Specific quality grade applies only to devices developed based on a customer designated "quality assurance program" for a specific application. The recommended applications of a device depend on its quality grade, as indicated below. Customers must check the quality grade of each device before using it in a particular application.
 - Standard: Computers, office equipment, communications equipment, test and measurement equipment, audio and visual equipment, home electronic appliances, machine tools, personal electronic equipment and industrial robots
 - Special: Transportation equipment (automobiles, trains, ships, etc.), traffic control systems, anti-disaster systems, anti-crime systems, safety equipment and medical equipment (not specifically designed for life support)
 - Specific: Aircraft, aerospace equipment, submersible repeaters, nuclear reactor control systems, life support systems or medical equipment for life support, etc.
- The quality grade of NEC devices is "Standard" unless otherwise specified in NEC's Data Sheets or Data Books. If customers intend to use NEC devices for applications other than those specified for Standard quality grade, they should contact an NEC sales representative in advance.