

6427525 N E C ELECTRONICS INC

05E 22772 D

BIPOLAR ANALOG INTEGRATED CIRCUIT

μ PC1238V, μ PC1238H

10 W AF POWER AMPLIFIER

T-74-05-01

The μ PC1238 is an audio power amplifier designed for median Hi-Fi stereo set and TV set sound power amplifier. This device can provide 8.4 watts to 8 ohm at 1 % T.H.D. and ± 13 V supply voltage. The μ PC1238 incorporates the thermal protection circuit to protect the damage of IC chip against load damping etc. Since the package is a 5 Pin TO-220 package, it greatly simplifies construction of a power amplifier both in design and assembly.

FEATURES

- High output power
 - 8.4 W TYP. (at 8 Ω , $V_{CC} = \pm 13$ V)
 - 12.5 W TYP. (at 4 Ω , $V_{CC} = \pm 13$ V)
- Low T.H.D.
 - 0.012 % TYP. ($P_{out} = 2$ W, $R_L = 8 \Omega$)
 - 0.02 % TYP. ($P_{out} = 2$ W, $R_L = 4 \Omega$)
- Low equivalent input noise voltage.
- Available for NFB tone control mode.
- Negligible power ON/OFF noise.
- High density components assembly due to 5 Pin TO-220 package.

CONNECTION DIAGRAM

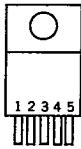

Pin No.	Electrical Connection
1	Non inverting input
2	Inverting input
3	-VCC
4	Output
5	+VCC

PACKAGE DIMENSIONS (Unit: mm)

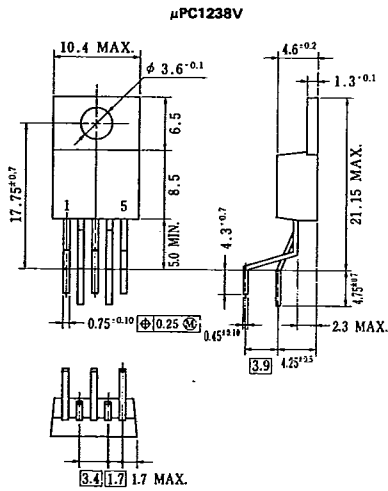

PSVP-140B2

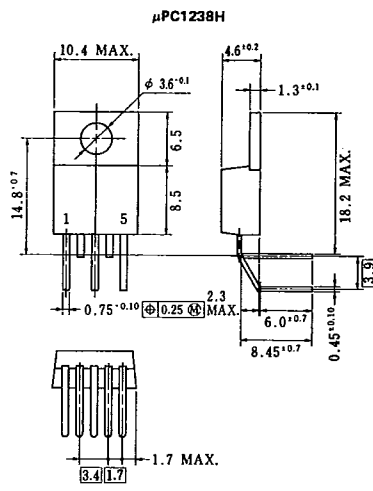

PSVP-140B1

μPC1238V, μPC1238H
05E 22773 D

6427525 N E C ELECTRONICS INC

T-74-05-01

ABSOLUTE MAXIMUM RATINGS (T_a = 25 °C)

Supply Voltage (Quiescent)	V _{CC}	±18	V
Supply Voltage (Operational)	V _{CC}	±15	V
Circuit Current	I _{CC(peak)}	4	A
Package Dissipation	P _D	*25	W
Junction Temperature	T _j	150	°C
Operating Temperature	T _{opt}	-20 to +65	°C
Storage Temperature	T _{stg}	-40 to +150	°C
Thermal Resistance Junction to Case	R _{th(j-c)}	3.4	°C/W

*T_{tab} = 65 °C

RECOMMENDED OPERATING CONDITIONS (T_a = 25 °C)

CHARACTERISTIC	SYMBOL	MIN.	TYP.	MAX.	UNIT
Operating Supply	V _{CC}	±6	±13	±15	V
Terminated Input Resistance	R _{IN}	47	56	100	kΩ
Closed Loop Voltage Gain	A _v	20	35		dB
Load Impedance	R _L	4	8		Ω

ELECTRICAL CHARACTERISTICS

(Refer to the test circuit : T_a = 25 °C, V_{CC} = ±13 V, A_v = 35 dB, R_G = 600 Ω, R_L = 8 Ω)

CHARACTERISTIC	SYMBOL	MIN.	TYP.	MAX.	UNIT	TEST CONDITIONS
Output Offset Voltage	V _{OFF}	-100	0	+100	mV	No Signal
Circuit Current	I _{CC}	30	60	130	mA	No Signal
Output Power	P _O	7	8.4		W	T.H.D. = 1 %, f = 1 kHz
Total Harmonic Distortion	T.H.D.		0.2	1	%	f = 40 Hz - 15 kHz P _O = 0.1 - 7 W
Open Loop Voltage Gain	A _{vo}		83		dB	P _O = 0.1 W, f = 500 Hz
Equivalent Input Noise Voltage	V _{NI}		3	10	μV _{r.m.s.}	R _G = 2.2 kΩ f = 40 Hz - 15 kHz (-3 dB)
Power Band Width	P.B.W.		75		kHz	P _O = 0.1 W, -3 dB
Supply Voltage Rejection Ratio	S.V.R.	45	51		dB	f = 100 Hz, R _G = 2.2 kΩ

5

μPC1238V, μPC1238H
6427525 N E C ELECTRONICS INC

05E 22774 D

TEST CIRCUIT & TYPICAL APPLICATIONS

T-74-05-01

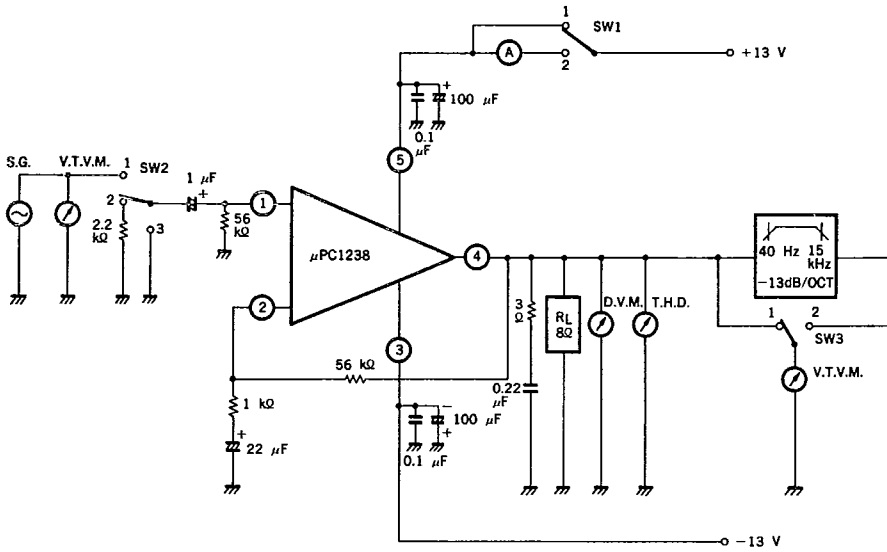

Switch Position

TEST ITEM	SYMBOL	SW1.	SW2.	SW3.
Output Offset Voltage	V_{OFF}	1	3	1
Circuit Current	I_{CC}	2	3	1
Output Power	P_O	1	1	1
Total Harmonic Distortion	T.H.D.	1	1	1
Equivalent Input Noise Voltage	V_{NI}	1	2	2
Supply Voltage Rejection Ratio	S.V.R.	1	2	1

6427525 N E C ELECTRONICS INC

μ PC1238V, μ PC1238H
05E 22775 D

T-74-05-01

TYPICAL CHARACTERISTICS ($T_a = 25^\circ\text{C}$)

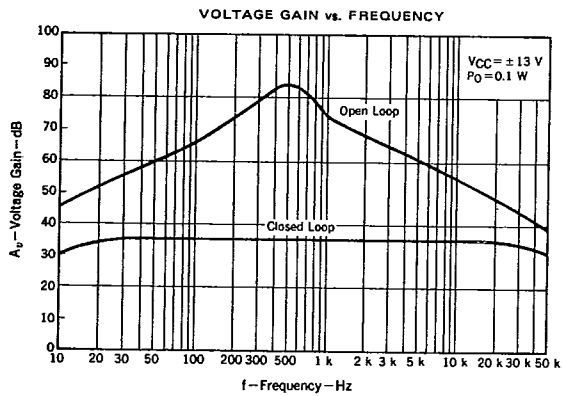
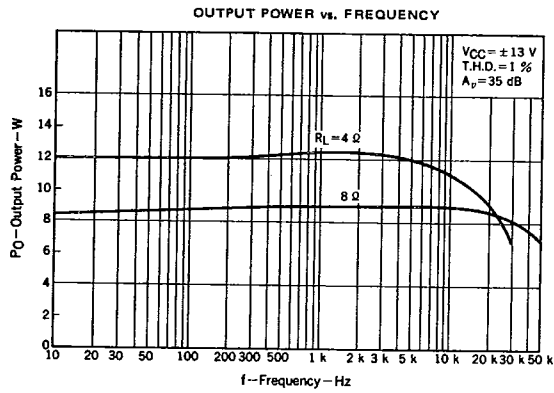
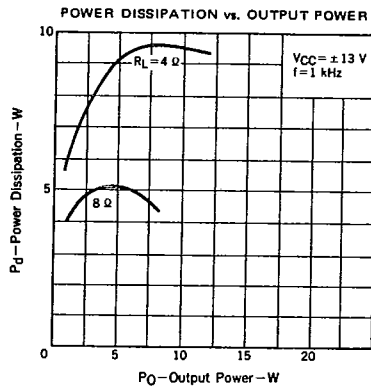
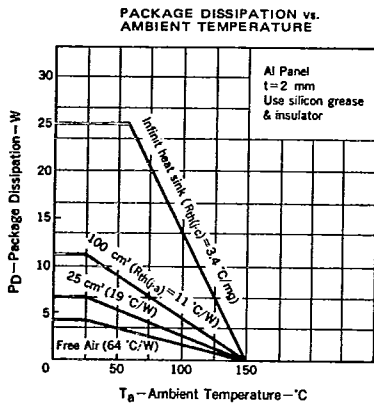

5

μ PC1238V, μ PC1238H
6427525 N E C ELECTRONICS INC

05E 22776 D
T-74-05-01

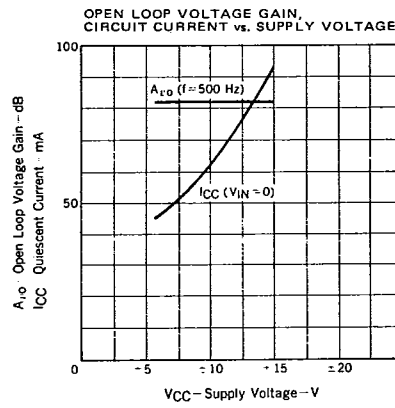
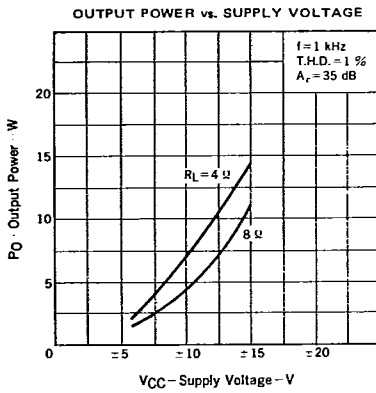
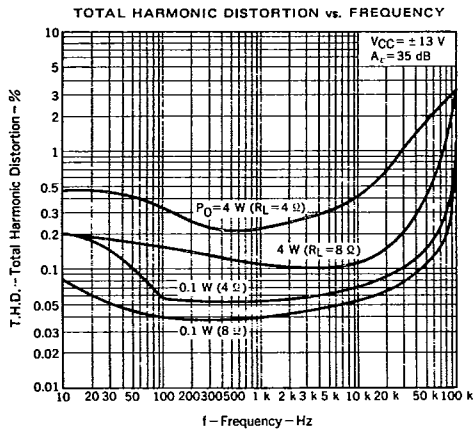
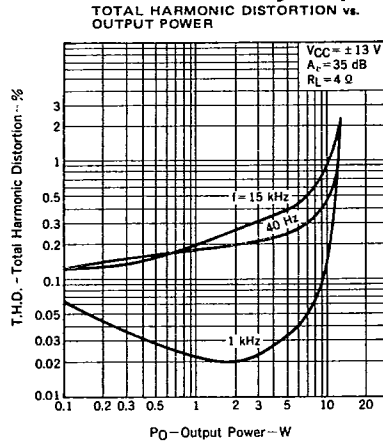
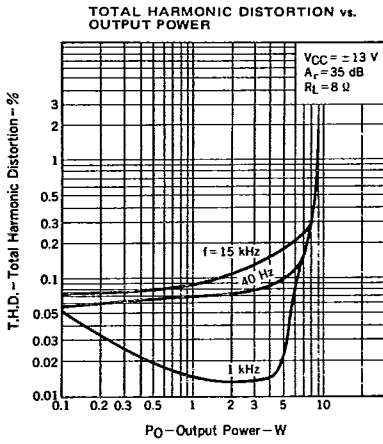

6427525 N E C ELECTRONICS INC

μ PC1238V, μ PC1238H
05E 22777 D

T-74-05-01

OUTPUT OFFSET VOLTAGE, SUPPLY
VOLTAGE REJECTION RATIO vs.
SUPPLY VOLTAGE

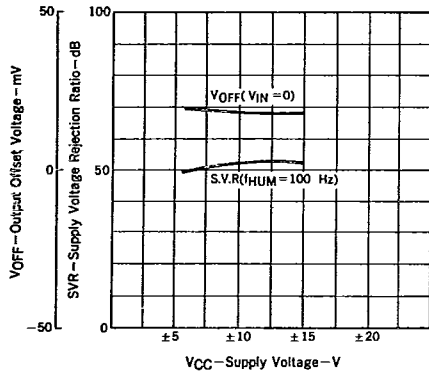

5