
Features

- Low Current Consumption: $I_{DD} < 100 \mu A$
- RC Oscillator
- Internal Reset During Power-up and Supply Voltage Drops (POR)
- “Short” Trigger Window for Active Mode
- “Long” Trigger Window for Sleep Mode
- Cyclical Wake-up of the Microcontroller in Sleep Mode
- Trigger Input
- Six Wake-up Inputs
- Reset Output
- Enable Output

Description

The digital window watchdog timer, U5020M, is a CMOS integrated circuit. In applications where safety is critical, it is especially important to monitor the microcontroller. Normal microcontroller operation is indicated by a cyclically transmitted trigger signal, which is received by a window watchdog timer within a defined time window.

A missing or a wrong trigger signal causes the watchdog timer to reset the microcontroller. The IC is tailored for microcontrollers which can work in both full-power and sleep mode. With an additional voltage monitoring (power-on reset and supply voltage drop reset), the U5020M offers a complete monitoring solution for microsystems in automotive and industrial applications.

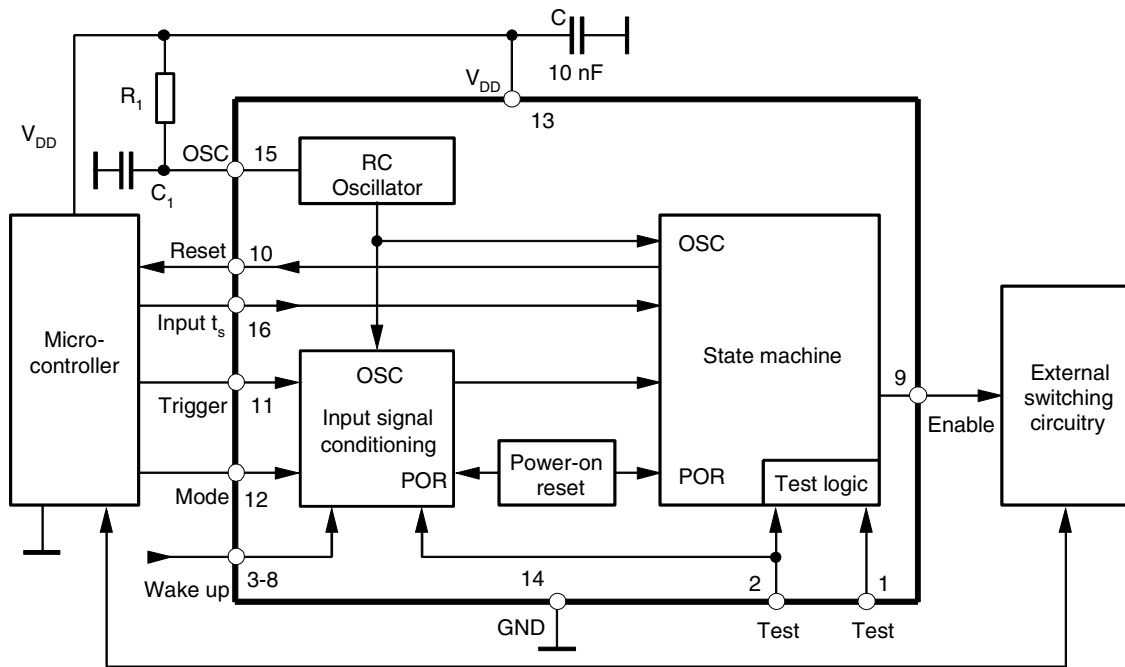


Digital Window Watchdog Timer

U5020M

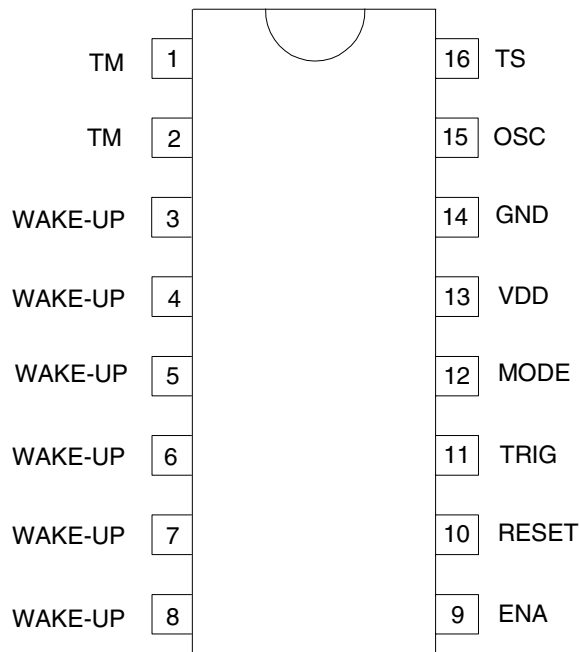


Figure 1. Block Diagram with External Circuit



Pin Configuration

Figure 2. Pinning SO16



Pin Description

Pin	Symbol	Function
1	TM	Test must not be connected
2	TM	Test must be connected to GND
3 to 8	WAKE-UP	Wake-up inputs (pull-down resistor) There are six digitally debounced wake-up inputs. During the long trigger mode each signal slope at the inputs initiates a reset pulse at pin 10.
9	ENA	Enable output (push-pull) It is used for the control of peripheral components. It is activated after the processor triggers three times correctly.
10	RESET	Reset output (open drain) Resets the processor in the case of a trigger error or if a wake-up pulse occurs during the long watchdog period.
11	TRIG	Trigger input (pull-up resistor) It is connected to the microprocessor's trigger signal.
12	MODE	Mode input (pull-up resistor) The processor's mode signal initiates the switchover between the long and the short watchdog time.
13	VDD	Supply voltage
14	GND	Ground, reference voltage
15	OSC	RC oscillator
16	TS	Time switch input Programming pin to select different time durations for the long watchdog time.

Functional Description

Supply, Pin 13

The U5020M requires a stabilized supply voltage $V_{DD} = 5\text{ V} \pm 5\%$ to comply with its electrical characteristics.

An external buffer capacitor of $C = 10\text{ nF}$ may be connected between pin 13 and GND.

RC Oscillator, Pin 15

The clock frequency, f , can be adjusted by the components R_1 and C_1 according to the formula:

$$f = \frac{1}{t}$$

where $t = 1.35 + 1.57 R_1 (C_1 + 0.01)$

R_1 in $k\Omega$, C_1 in nF and t in μs

The clock frequency determines all time periods of the logic part as shown in the table "Electrical Characteristics" under the subheading "Timing" on page 8. With an appropriate component selection, the clock frequency, f , is nearly independent of the supply voltage as shown in Figure 3 on page 4.

Frequency tolerance $\Delta f_{max} = 10\%$ with $R_1 \pm 1\%$, $C_1 = \pm 5\%$

Figure 3. Period t versus R_1 , at $C_1 = 500$ pF

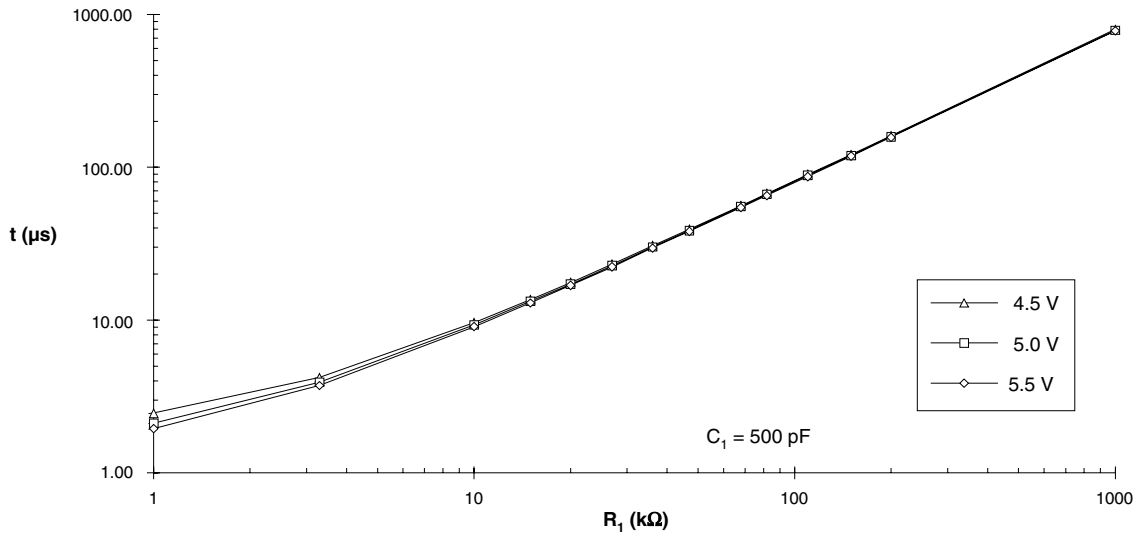


Figure 4. Power-up Reset and Mode Switchover



Supply Voltage Monitoring, Pin 10

The integrated power-on reset (POR) circuitry sets the internal logic to a defined basic status and generates a reset pulse at the reset output, pin 10, during ramp-up of the supply voltage and in the case of voltage drops of the supply. A hysteresis in the POR threshold prevents the circuit from oscillating. During ramp-up of the supply voltage, the reset output stays active for a specified period of time (t_0) in order to bring the microcontroller in its defined reset status (see Figure 4). Pin 10 has an open-drain output.

Switch-over Mode Time, Pin 12

The switch-over mode time enables the synchronous operation of microcontroller and watchdog. When the power-up reset time has elapsed, the watchdog has to be switched to monitoring mode by the microcontroller by a “low” signal transmitted to the mode pin (pin 12) within the time-out period, t_1 . If the low signal does not occur within t_1 , (see Figure 4) the watchdog generates a reset pulse, t_6 , and the time, t_1 , starts again. Microcontroller and watchdog are synchronized with the switchover mode time, t_1 , each time a reset pulse is generated.

Microcontroller in Active Mode

Monitoring with the “Short” Trigger Window

After the switch-over mode the watchdog operates in short watchdog mode and expects a trigger pulse from the microcontroller within the defined time window, t_3 , (enable time). The watchdog generates a reset pulse which resets the microcontroller if

- the trigger pulse duration is too long
- the trigger pulse is within the disable time, t_2
- there is no trigger pulse

Figure 5 shows the pulse diagram with a missing trigger pulse.

Figure 5. Pulse Diagram with no Trigger Pulse During the Short Watchdog Time

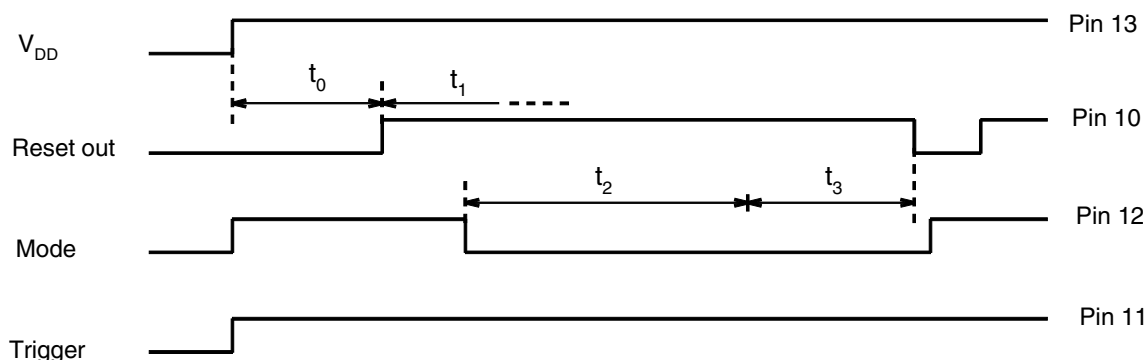


Figure 6 on page 6 shows a correct trigger sequence. The positive edge of the trigger signal starts a new monitoring cycle with the disable time, t_2 . To ensure correct operation of the microcontroller, the watchdog needs to be triggered three times correctly before it sets its enable output. This feature is used to activate or deactivate safety-critical components which have to be switched to a certain condition (emergency status) in the case of a microcontroller malfunction. As soon as there is an incorrect trigger sequence, the enable signal is reset and it takes a sequence of three correct triggers before enable is reset.

Microcontroller in Sleep Mode

Monitoring with the “Long” Trigger Window

The long watchdog mode allows cyclical wake-up of the microcontroller during sleep mode. As in short watchdog mode, there is a disable time, t_4 , and an enable time, t_5 , in which a trigger signal is accepted. The watchdog can be switched from the short trigger window to the long trigger window with a “high” potential at the mode pin (pin 12). In contrast to the short watchdog mode, the time periods are now much longer and the enable output remains inactive so that other components can be switched off to effect a further decrease in current consumption. As soon as a wake-up signal at one of the 6 wake up inputs (pins 3 to 8) is detected, the long watchdog mode ends, a reset pulse wakes-up the sleeping microcontroller and the normal monitoring cycle starts with the mode switch-over time.

By means of a low or high potential at pin 16 (time switch), two values for the long watchdog time can be selected.

Figure 6. Pulse Diagram of a Correct Trigger Sequence During the Short Watchdog Time

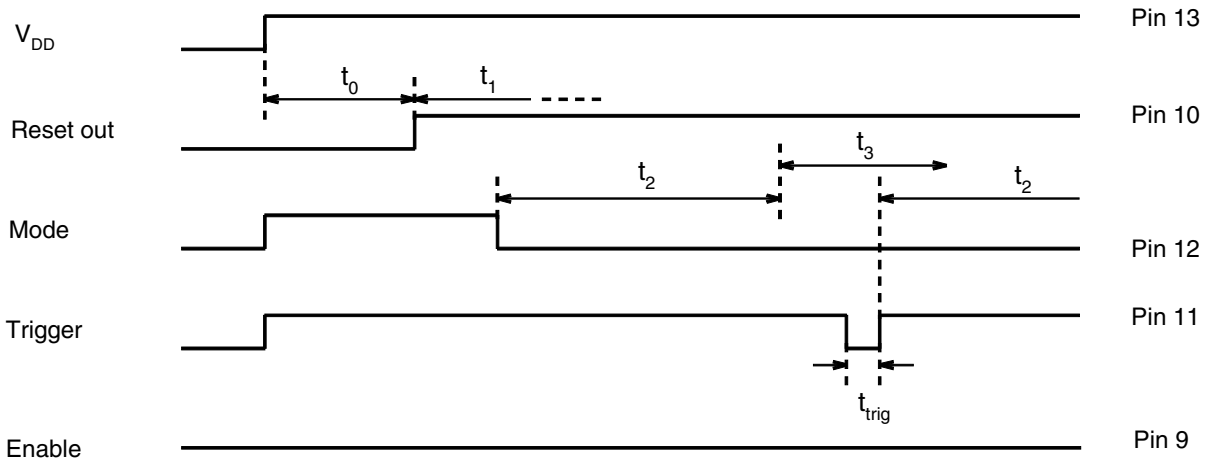
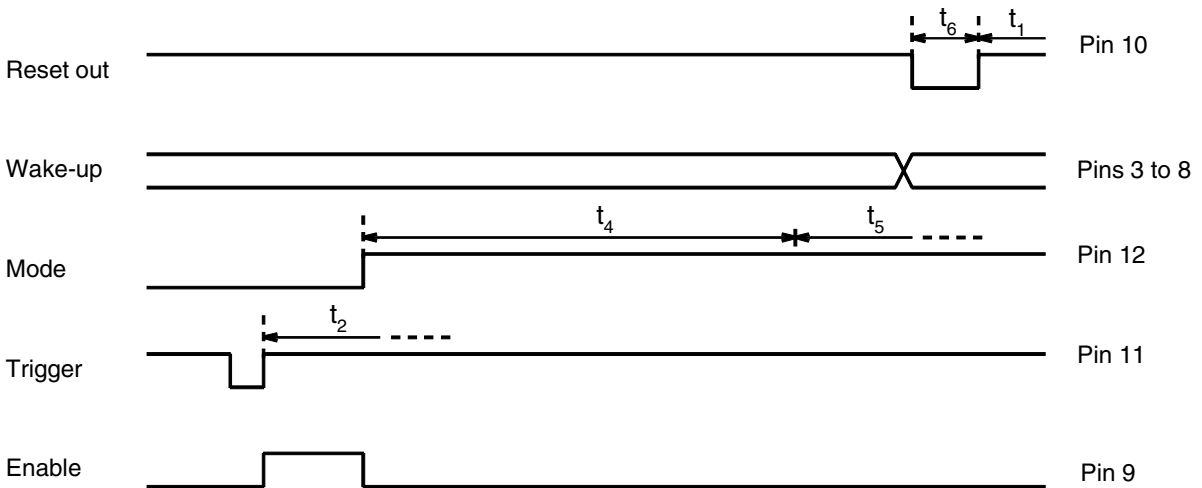


Figure 7 shows the switch-over from the short to the long watchdog mode. The wake-up signal during the enable time, t_5 , activates a reset pulse, t_6 .

The watchdog can be switched back from the long to the short watchdog mode with a low potential at the mode pin (pin 12).

Figure 7. Pulse Diagram of the Long Watchdog Time



Application Hint

In order to prevent the IC from an undesired reset output signal which may be caused by transients on the supply under certain conditions, a PC board connection from pin 2 to GND is strongly recommended.

Absolute Maximum Ratings

Stresses beyond those listed under “Absolute Maximum Ratings” may cause permanent damage to the device. This is a stress rating only and functional operation of the device at these or any other conditions beyond those indicated in the operational sections of this specification is not implied. Exposure to absolute maximum rating conditions for extended periods may affect device reliability.

Parameters	Symbol	Value	Unit
Supply voltage	V_{DD}	6.5	V
Output current	I_{OUT}	± 2	mA
Input voltage	V_{IN}	-0.5 V to $V_{DD} + 0.5$ V	V
Ambient temperature range	T_{amb}	-40 to +85	°C
Storage temperature range	T_{stg}	-55 to +150	°C

Thermal Resistance

Parameters	Symbol	Value	Unit
Junction ambient SO16	R_{thJA}	160	K/W

Electrical Characteristics

$V_{DD} = 5\text{ V}$; $T_{amb} = -40^{\circ}\text{C}$ to $+85^{\circ}\text{C}$; reference point is ground (pin14); Figure 4 on page 4, unless otherwise specified

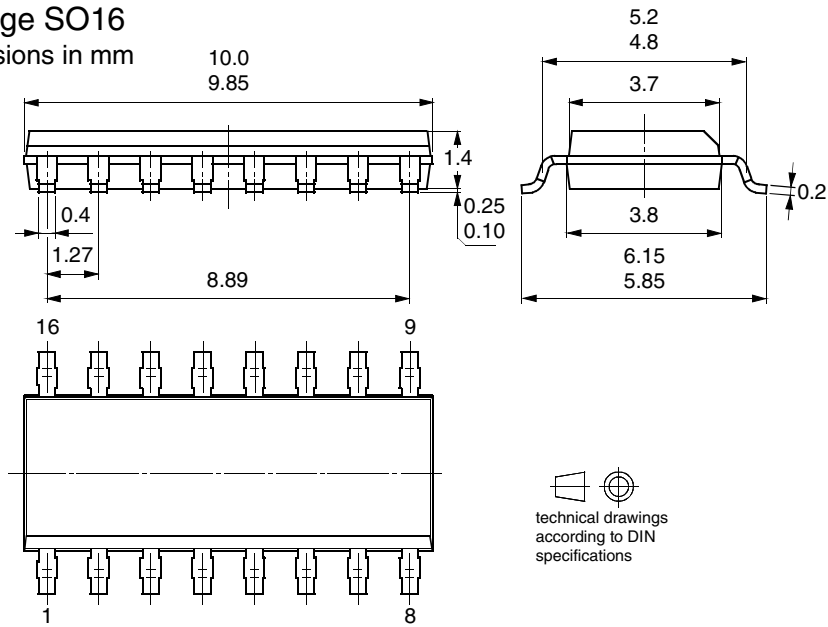
Parameters	Test Conditions	Pin	Symbol	Min.	Typ.	Max.	Unit
Supply voltage		13	V_{DD}	4.5		5.5	V
Current consumption	$R_1 = 66\text{ k}\Omega$	13	I_{DD}			100	μA
Power-on reset	Logic functions	13	V_{DD}	1			V
Power-on reset	Threshold	13	V_{POR}		3.8		V
Power-on reset	Hysteresis	13	V_{hys}		100		mV
Inputs		3 to 8, 11, 12, 16					
Upper threshold ("1")			V_{IH}	4.0			V
Lower threshold ("0")			V_{IL}			1.0	V
Input voltage range			V_{IN}	-0.4		$V_{DD} + 0.2$	V
Input current	Depending on pin		I_{IN}	-20		20	μA
Output Pin 9							
Maximum output current			I_{OUT}	2			mA
Upper output voltage ("1")	$I_{OUT} = 1\text{ mA}$		V_{OH}	4.5			V
Lower output voltage ("0")	$I_{OUT} = -1\text{ mA}$		V_{OL}			0.5	V
Output Pin 10							
Maximum output current			I_{OUT}	2			mA
Lower output voltage ("0")	$I_{OUT} = -1\text{ mA}$		V_{OL}			0.5	V
Timing							
Debounce period	Trig, Mode	11, 12		3		4	cycle
Debounce period	Wake-up 1-6	3 to 8		96		128	cycle
Maximum trigger pulse period					45		cycle
Power-up reset time			t_0		201		cycle
Time-out period			t_1		1,112		cycle
Short disable time			t_2		130		cycle
Short enable time			t_3		124		cycle
Long disable time	Input switch = low (0)	16	t_4		71,970		cycle
Long enable time	Input switch = low (0)	16	t_5		30,002		cycle
Long disable time	Input switch = high (1)	16	t_4		1,200		cycle
Long enable time	Input switch = high (1)	16	t_5		400		cycle
Reset-out time			t_6		40		cycle

Ordering Information

Extended Type Number	Package	Remarks
U5020M-FP	SO16	–

Package Information

Package SO16
Dimensions in mm





Atmel Corporation

2325 Orchard Parkway
San Jose, CA 95131, USA
Tel: 1(408) 441-0311
Fax: 1(408) 487-2600

Regional Headquarters

Europe

Atmel Sarl
Route des Arsenalux 41
Case Postale 80
CH-1705 Fribourg
Switzerland
Tel: (41) 26-426-5555
Fax: (41) 26-426-5500

Asia

Room 1219
Chinachem Golden Plaza
77 Mody Road Tsimshatsui
East Kowloon
Hong Kong
Tel: (852) 2721-9778
Fax: (852) 2722-1369

Japan

9F, Tonetsu Shinkawa Bldg.
1-24-8 Shinkawa
Chuo-ku, Tokyo 104-0033
Japan
Tel: (81) 3-3523-3551
Fax: (81) 3-3523-7581

Atmel Operations

Memory

2325 Orchard Parkway
San Jose, CA 95131, USA
Tel: 1(408) 441-0311
Fax: 1(408) 436-4314

Microcontrollers

2325 Orchard Parkway
San Jose, CA 95131, USA
Tel: 1(408) 441-0311
Fax: 1(408) 436-4314

La Chantrerie
BP 70602
44306 Nantes Cedex 3, France
Tel: (33) 2-40-18-18-18
Fax: (33) 2-40-18-19-60

ASIC/ASSP/Smart Cards

Zone Industrielle
13106 Rousset Cedex, France
Tel: (33) 4-42-53-60-00
Fax: (33) 4-42-53-60-01

1150 East Cheyenne Mtn. Blvd.
Colorado Springs, CO 80906, USA
Tel: 1(719) 576-3300
Fax: 1(719) 540-1759

Scottish Enterprise Technology Park
Maxwell Building
East Kilbride G75 0QR, Scotland
Tel: (44) 1355-803-000
Fax: (44) 1355-242-743

RF/Automotive

Theresienstrasse 2
Postfach 3535
74025 Heilbronn, Germany
Tel: (49) 71-31-67-0
Fax: (49) 71-31-67-2340

1150 East Cheyenne Mtn. Blvd.
Colorado Springs, CO 80906, USA
Tel: 1(719) 576-3300
Fax: 1(719) 540-1759

Biometrics/Imaging/Hi-Rel MPU/ High Speed Converters/RF Datacom

Avenue de Rochepleine
BP 123
38521 Saint-Egreve Cedex, France
Tel: (33) 4-76-58-30-00
Fax: (33) 4-76-58-34-80

Literature Requests

www.atmel.com/literature

Disclaimer: Atmel Corporation makes no warranty for the use of its products, other than those expressly contained in the Company's standard warranty which is detailed in Atmel's Terms and Conditions located on the Company's web site. The Company assumes no responsibility for any errors which may appear in this document, reserves the right to change devices or specifications detailed herein at any time without notice, and does not make any commitment to update the information contained herein. No licenses to patents or other intellectual property of Atmel are granted by the Company in connection with the sale of Atmel products, expressly or by implication. Atmel's products are not authorized for use as critical components in life support devices or systems.

© Atmel Corporation 2003. All rights reserved.

Atmel® and combinations thereof are the registered trademarks of Atmel Corporation or its subsidiaries.

Other terms and product names may be the trademarks of others.



Printed on recycled paper.