

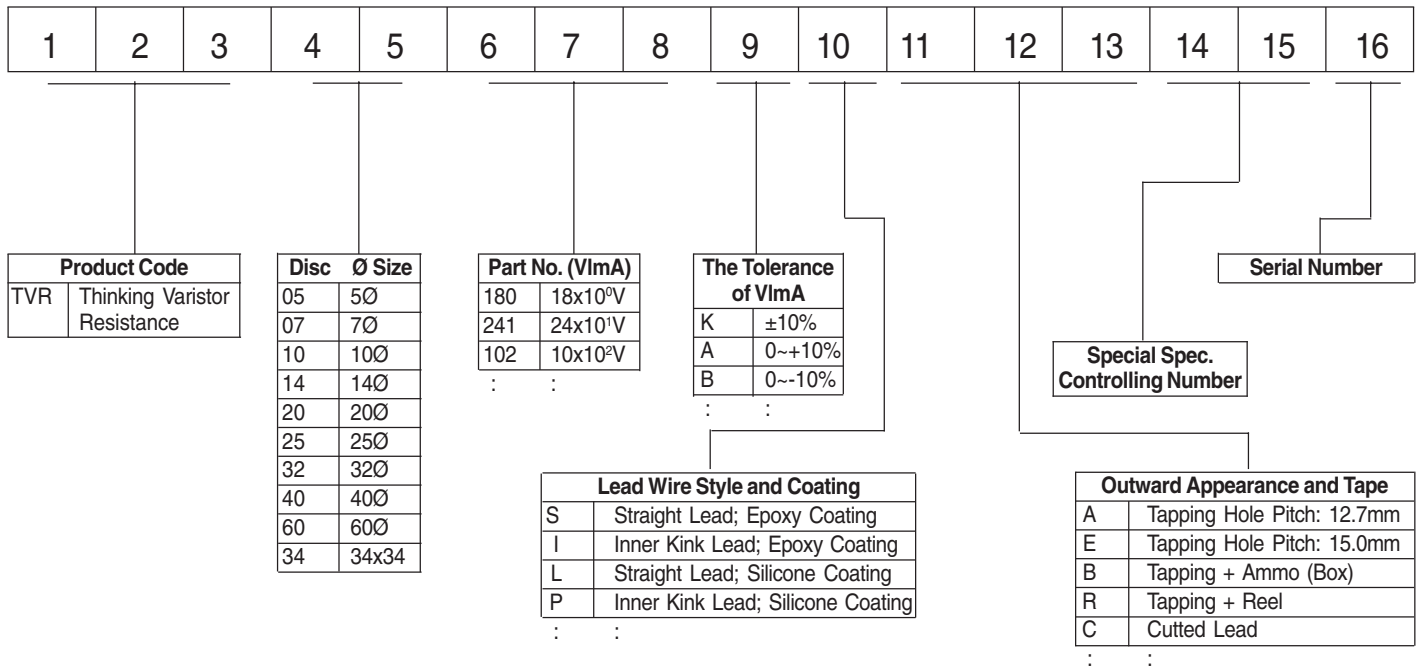

TVR-SERIES Part Number Code



www.DataSheet.in



ZINC OXIDE VARISTOR 5Ø SERIES

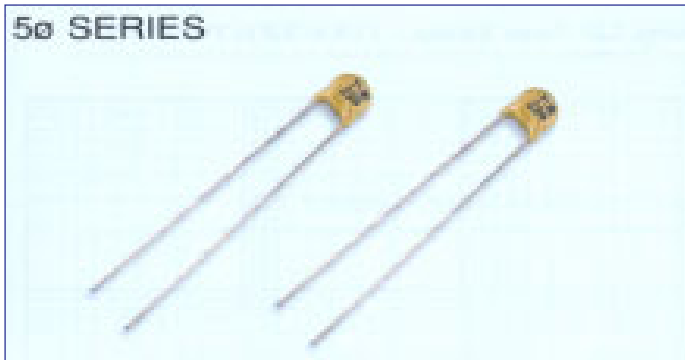

DIMENSION

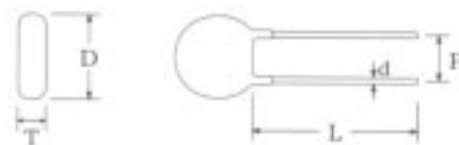

Unit: mm

Disc Ø	D max.	L min.	d nor.	P nor.
5	7.5	30	0.6±0.02	5±1

SPECIFICATION

Part No	Varistor Voltage			Max. Allowable Voltage		Max. Clamping Voltage		Max. Energy (8/20µs)	Max. Peak Current (8/20µs)	Rated Power (W)	Reference Capacitance (@1KHZ pf)	Dimensions T(max.) (mm)
	VImA (V)	AC rms (V)	DC (V)	Vp (V)	Ip (A)	10/1000 (J)	1time (A)					
TVR 05 180	18	11	14	40	1	0.4	100	50	0.01	1600	3.9	
TVR 05 220	22	14	18	48	1	0.5	100	50	0.01	1500	4.1	
TVR 05 270	27	17	22	60	1	0.6	100	50	0.01	1450	4.3	
TVR 05 330	33	20	26	73	1	0.8	100	50	0.01	1400	4.5	
TVR 05 390	39	25	31	86	1	0.9	100	50	0.01	1100	4.0	
TVR 05 470	47	30	38	104	1	1.1	100	50	0.01	850	4.1	
TVR 05 560	56	35	45	123	1	1.3	100	50	0.01	600	4.3	
TVR 05 680	68	40	56	150	1	1.6	100	50	0.01	580	4.6	
TVR 05 820	82	50	65	145	5	2.5	400	200	0.1	460	4.0	
TVR 05 101	100	60	85	175	5	3.0	400	200	0.1	400	4.2	
TVR 05 121	120	75	100	210	5	4.0	400	200	0.1	350	4.4	
TVR 05 151	150	95	125	260	5	4.8	400	200	0.1	300	4.7	
TVR 05 181	180	115	150	315	5	5.9	400	200	0.1	150	4.2	
TVR 05 201	200	130	170	355	5	6.5	400	200	0.1	140	4.3	
TVR 05 221	220	140	180	380	5	7.0	400	200	0.1	130	4.4	
TVR 05 241	240	150	200	415	5	8.0	400	200	0.1	120	4.5	
TVR 05 271	270	175	225	475	5	8.5	400	200	0.1	110	4.7	
TVR 05 301	300	195	250	525	5	8.5	400	200	0.1	100	4.6	
TVR 05 331	330	215	275	585	5	9.2	400	200	0.1	105	4.7	
TVR 05 361	360	230	300	620	5	10	400	200	0.1	90	4.8	
TVR 05 391	390	250	320	675	5	12	400	200	0.1	85	5.0	
TVR 05 431	430	275	350	745	5	13	400	200	0.1	80	5.2	
TVR 05 471	470	300	385	810	5	15	400	200	0.1	75	5.3	

www.DataSheet.in





LIFE TIMES

Surge Life Times Ratings (TVR 05 180 to TVR 05 680)

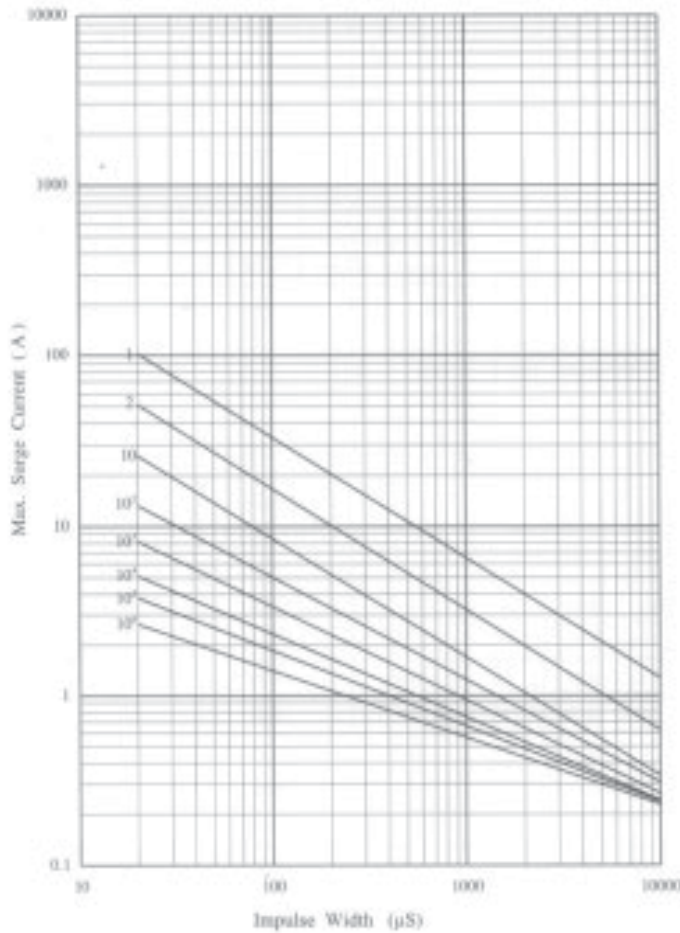

Surge Life Times Ratings (TVR 05 820 to TVR 05 471)

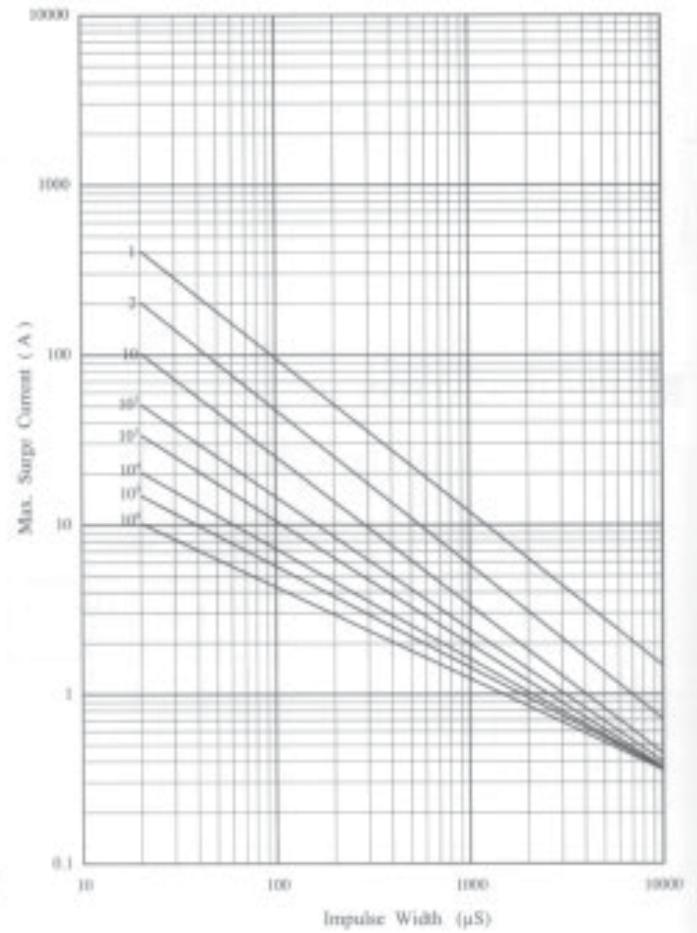

V-I CHARACTERISTIC CURVE

Max. Leakage Current and Max. Clamping Voltage Curves (TVR 05 180 to TVR 05 680)

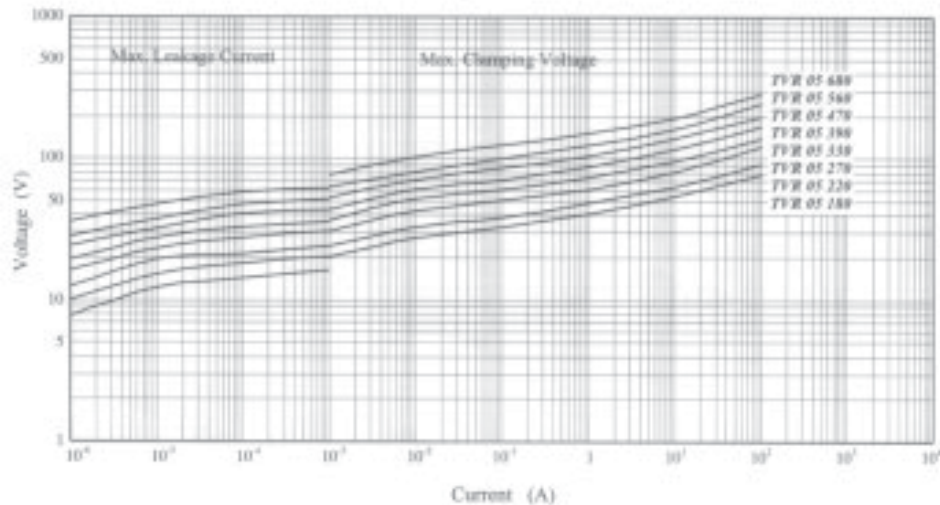

Max. Leakage Current and Max. Clamping Voltage Curves (TVR 05 820 to TVR 05 471)

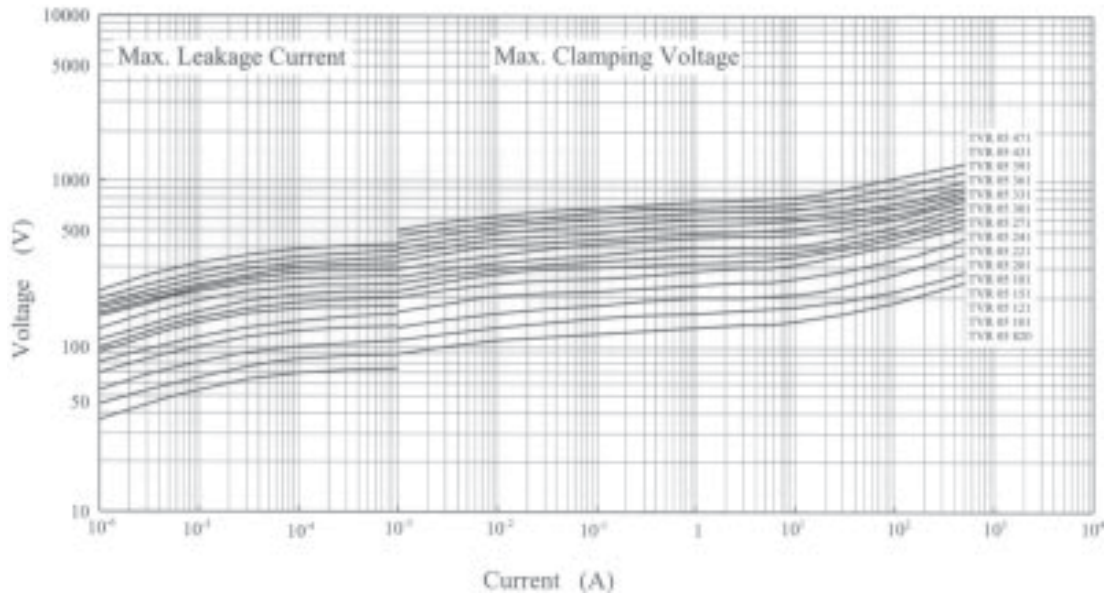

POWER DERATING CURVE

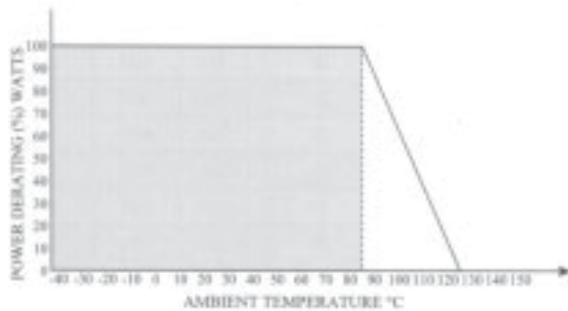



ZINC OXIDE VARISTOR 7Ø SERIES

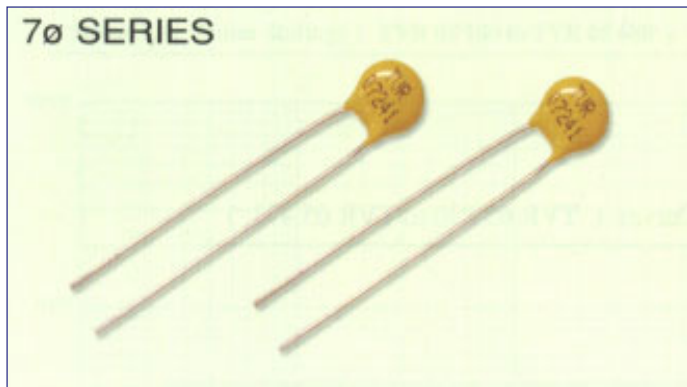

DIMENSION

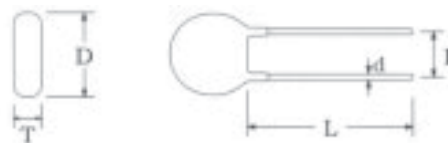

Unit: mm

Disc Ø	D max.	L min.	d nor.	P nor.
7	9.5	30	0.6±0.02	5±1

SPECIFICATION

Part No	Varistor Voltage			Max. Allowable Voltage		Max. Clamping Voltage		Max. Energy		Max. Peak Current (8/20µs)		Rated Power	Reference Capacitance	Dimensions
	VImA (V)	AC rms (V)	DC (V)	Vp (V)	Ip (A)	10/1000 (J)	1time (A)	2times (A)	(W)	@1KHZ (pf)	T(max.) (mm)			
TVR 07 180	18	11	14	36	2.5	0.9	250	125	0.02	3800	3.9			
TVR 07 220	22	14	18	43	2.5	1.1	250	125	0.02	3600	4.1			
TVR 07 270	27	17	22	53	2.5	1.4	250	125	0.02	3400	4.3			
TVR 07 330	33	20	26	65	2.5	1.7	250	125	0.02	2900	4.5			
TVR 07 390	39	25	31	77	2.5	2.1	250	125	0.02	1620	4.0			
TVR 07 470	47	30	38	93	2.5	2.5	250	125	0.02	1550	4.1			
TVR 07 560	56	35	45	110	2.5	3.1	250	125	0.02	1500	4.3			
TVR 07 680	68	40	56	135	2.5	3.6	250	125	0.02	1200	4.6			
TVR 07 820	82	50	65	135	10	5.5	1200	600	0.25	900	4.0			
TVR 07 101	100	60	85	165	10	6.5	1200	600	0.25	750	4.2			
TVR 07 121	120	75	100	200	10	7.8	1200	600	0.25	620	4.4			
TVR 07 151	150	95	125	250	10	9.7	1200	600	0.25	500	4.7			
TVR 07 181	180	115	150	300	10	11.7	1200	600	0.25	400	4.2			
TVR 07 201	200	130	170	340	10	13	1200	600	0.25	360	4.3			
TVR 07 221	220	140	180	360	10	14	1200	600	0.25	310	4.4			
TVR 07 241	240	150	200	395	10	15	1200	600	0.25	290	4.5			
TVR 07 271	270	175	225	455	10	18	1200	600	0.25	260	4.7			
TVR 07 301	300	195	250	500	10	21	1200	600	0.25	230	4.6			
TVR 07 331	330	215	275	550	10	23	1200	600	0.25	210	4.7			
TVR 07 361	360	230	300	595	10	25	1200	600	0.25	190	4.8			
TVR 07 391	390	250	320	650	10	25	1200	600	0.25	180	5.0			
TVR 07 431	430	275	350	710	10	28	1200	600	0.25	160	5.2			
TVR 07 471	470	300	385	775	10	30	1200	600	0.25	150	5.3			
TVR 07 511	510	320	410	845	10	33	1200	600	0.25	140	5.5			
TVR 07 561	560	350	450	930	10	33	1200	600	0.25	130	5.7			
TVR 07 621	620	395	510	1020	10	35	1200	600	0.25	120	6.0			
TVR 07 681	680	420	560	1120	10	35	1200	600	0.25	110	6.3			
TVR 07 751	750	465	615	1235	10	38	1200	600	0.25	100	6.6			
TVR 07 821	820	510	670	1355	10	42	1200	600	0.25	90	6.5			



LIFE TIMES

Surge Life Times Ratings (TVR 07 180 to TVR 07 680)

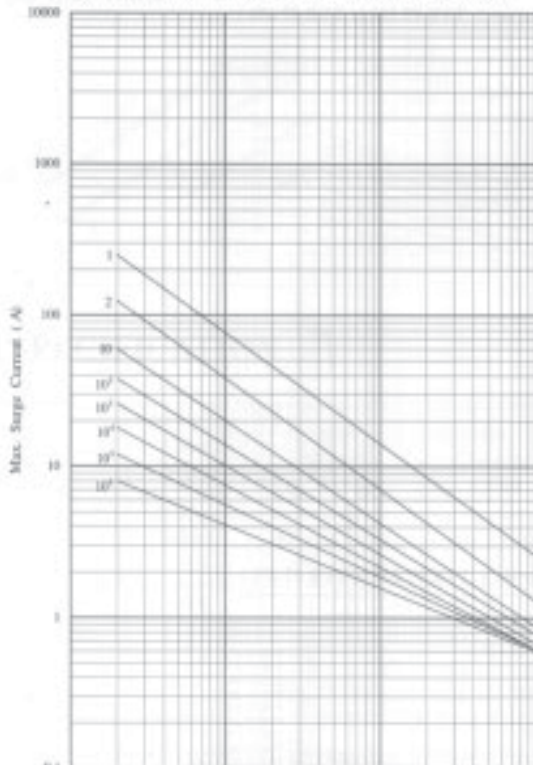

Surge Life Times Ratings (TVR 07 511 to TVR 07 821)

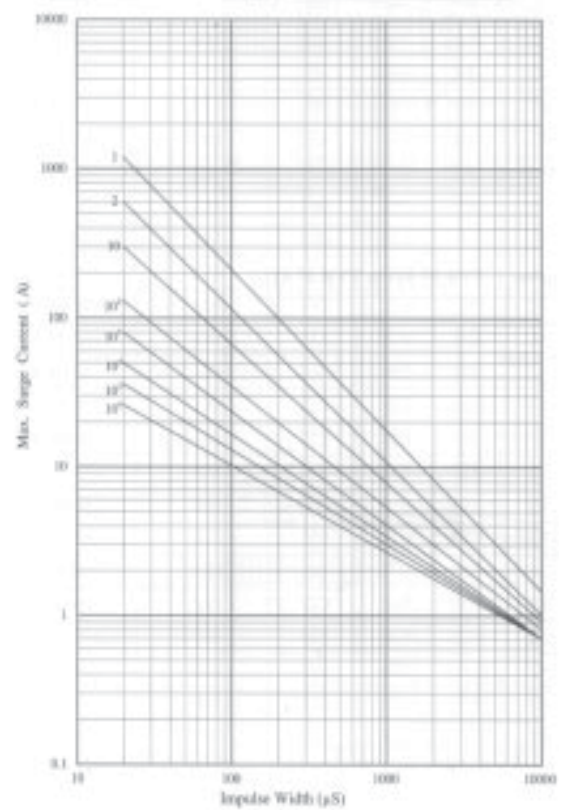

Surge Life Times Ratings (TVR 07 820 to TVR 07 471)

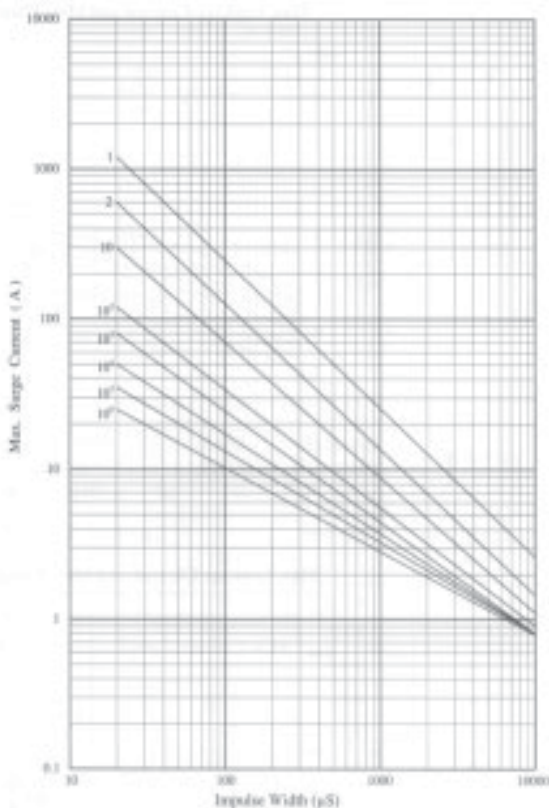

POWER DERATING CURVE

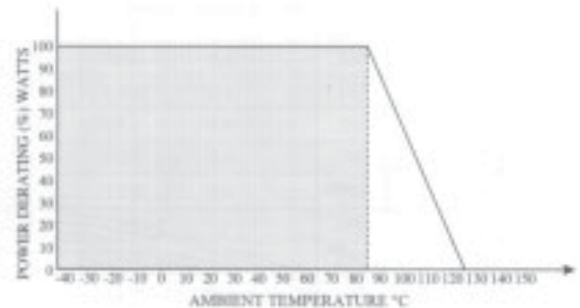



V-I CHARACTERISTIC CURVE

Max. Leakage Current and Max. Clamping Voltage Curves (TVR 07 180 to TVR 07 650)

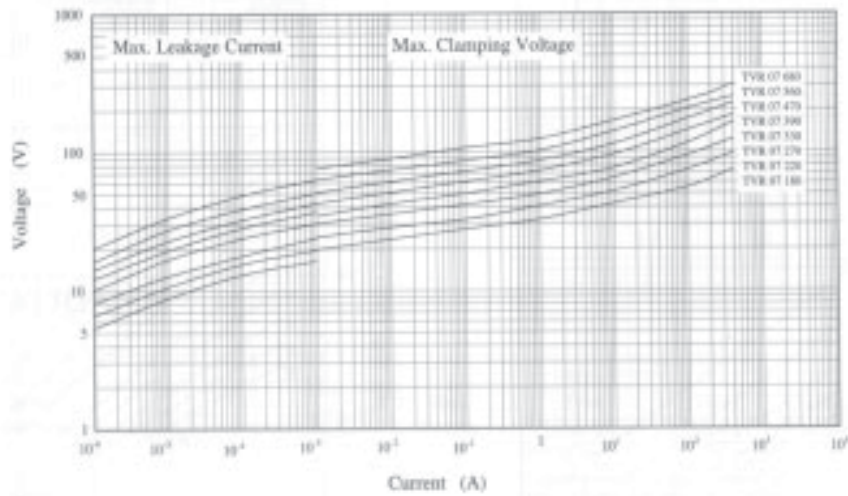

Max. Leakage Current and Max. Clamping Voltage Curves (TVR 07 820 to TVR 07 471)

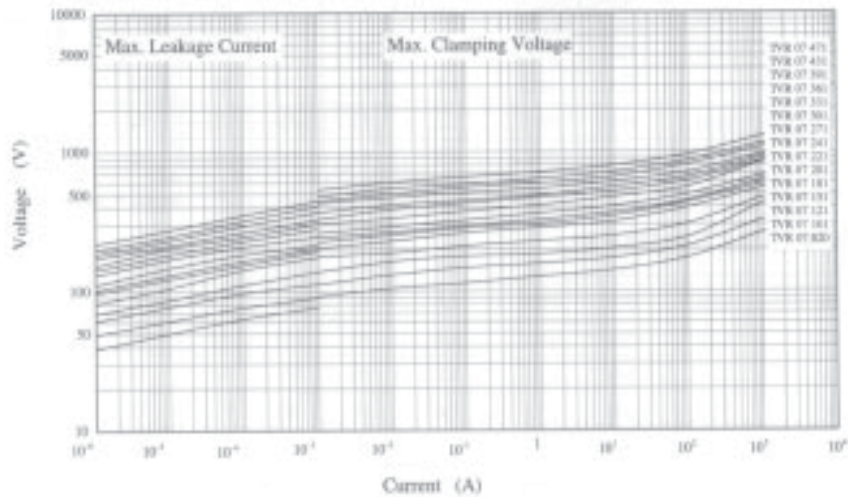

Max. Leakage Current and Max. Clamping Voltage Curves (TVR 07 511 to TVR 07 821)

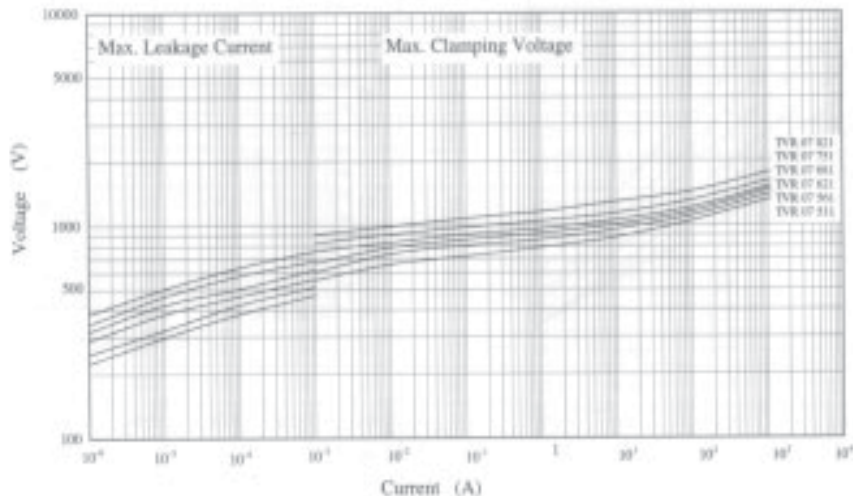



ZINC OXIDE VARISTOR 100 SERIES

100 SERIES



DIMENSION

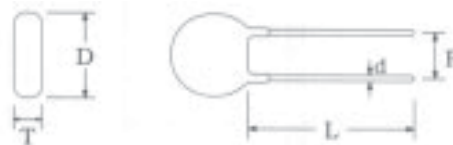

Unit: mm

Disc Ø	D max.	L min.	d nor.	P nor.
10	12.5	30	0.8±0.02	7.5±1

SPECIFICATION

Part No	Max. Allowable Voltage			Max. Clamping Voltage		Max. Energy 10/1000 (J)	Max. Peak Current (8/20µs)		Rated Power (W)	Reference Capacitance @1KHZ (pf)	Dimensions T(max.) (mm)
	Varistor Voltage VImA (V)	AC rms (V)	DC (V)	Vp (V)	Ip (A)		1time (A)	2times (A)			
TVR 10 180	18	11	14	36	5	2.1	500	250	0.05	10000	4.3
TVR 10 220	22	14	18	43	5	2.5	500	250	0.05	8000	4.5
TVR 10 270	27	17	22	53	5	3.0	500	250	0.05	6500	4.7
TVR 10 330	33	20	26	65	5	4.0	500	250	0.05	5800	4.9
TVR 10 390	39	25	31	77	5	4.6	500	250	0.05	4500	4.4
TVR 10 470	47	30	38	93	5	5.5	500	250	0.05	4000	4.5
TVR 10 560	56	35	45	110	5	7.0	500	250	0.05	3500	4.7
TVR 10 680	68	40	56	135	5	8.2	500	250	0.05	2500	5.0
TVR 10 820	82	50	65	135	25	12	2500	1300	0.4	1700	4.4
TVR 10 101	100	60	85	165	25	15	2500	1300	0.4	1400	4.6
TVR 10 121	120	75	100	200	25	18	2500	1300	0.4	1100	4.8
TVR 10 151	150	95	125	250	25	22	2500	1300	0.4	900	5.1
TVR 10 181	180	115	150	300	25	27	2500	1300	0.4	700	4.6
TVR 10 201	200	130	170	340	25	30	2500	1300	0.4	610	4.7
TVR 10 221	220	140	180	360	25	32	2500	1300	0.4	550	4.8
TVR 10 241	240	150	200	395	25	35	2500	1300	0.4	500	4.9
TVR 10 271	270	175	225	455	25	40	2500	1300	0.4	450	5.1
TVR 10 301	300	195	250	500	25	40	2500	1300	0.4	400	5.0
TVR 10 331	330	215	275	550	25	43	2500	1300	0.4	360	5.1
TVR 10 361	360	230	300	595	25	47	2500	1300	0.4	330	5.2
TVR 10 391	390	250	320	650	25	60	2500	1300	0.4	300	5.4
TVR 10 431	430	275	350	710	25	65	2500	1300	0.4	270	5.6
TVR 10 471	470	300	385	775	25	70	2500	1300	0.4	250	5.7
TVR 10 511	510	320	410	845	25	70	2500	1300	0.4	230	5.9
TVR 10 561	560	350	450	930	25	70	2500	1300	0.4	210	6.1
TVR 10 621	620	395	510	1020	25	70	2500	1300	0.4	190	6.4
TVR 10 681	680	420	560	1120	25	70	2500	1300	0.4	170	6.7
TVR 10 751	750	465	615	1235	25	75	2500	1300	0.4	160	7.0
TVR 10 821	820	510	670	1355	25	85	2500	1300	0.4	150	6.9
TVR 10 911	910	550	745	1500	25	93	2500	1300	0.4	140	7.3
TVR 10 102	1000	625	825	1650	25	102	2500	1300	0.4	130	7.7
TVR 10 112	1100	680	895	1815	25	115	2500	1300	0.4	120	8.1



LIFE TIMES

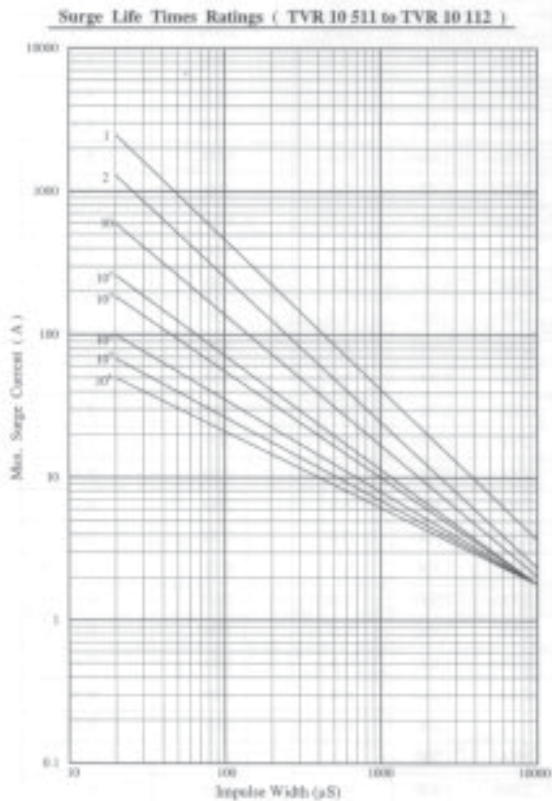
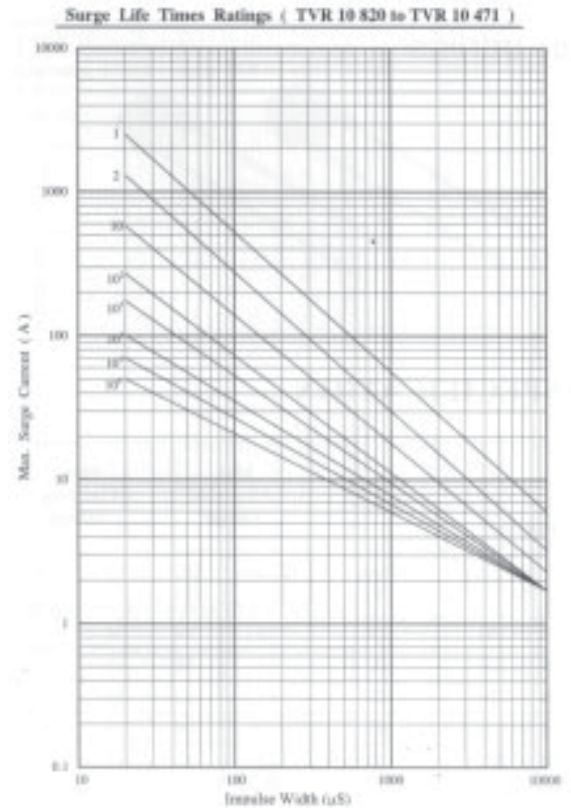
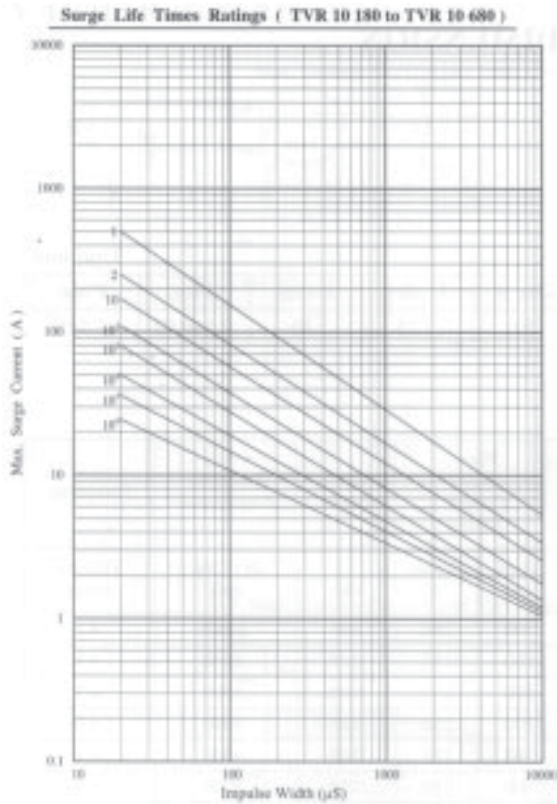

POWER DERATING CURVE

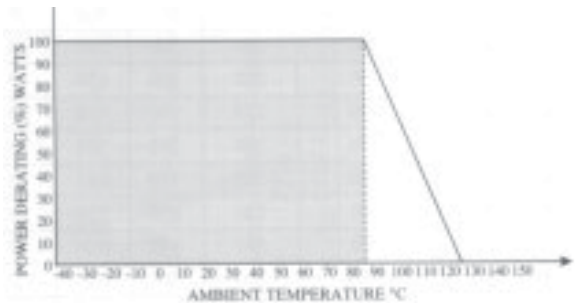



V-I CHARACTERISTIC CURVE

Max. Leakage Current and Max. Clamping Voltage Curves (TVR 10 150 to TVR 10 680)

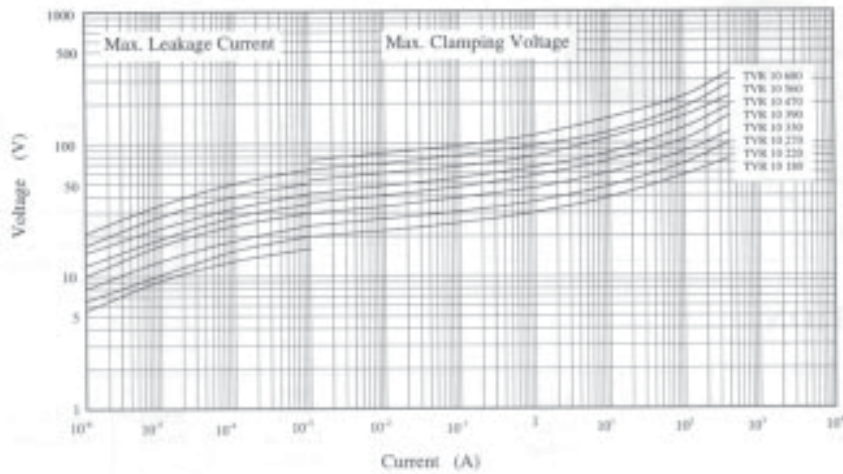

Max. Leakage Current and Max. Clamping Voltage Curves (TVR 10 820 to TVR 10 471)

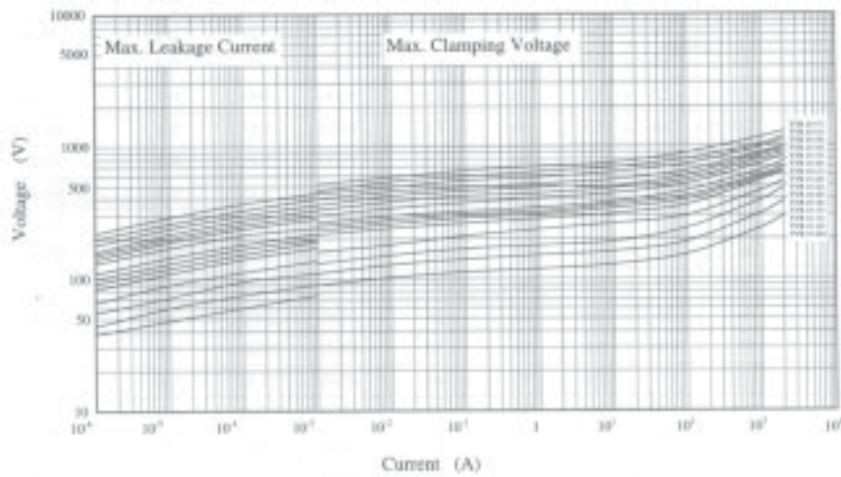

Max. Leakage Current and Max. Clamping Voltage Curves (TVR 10 511 to TVR 10 112)

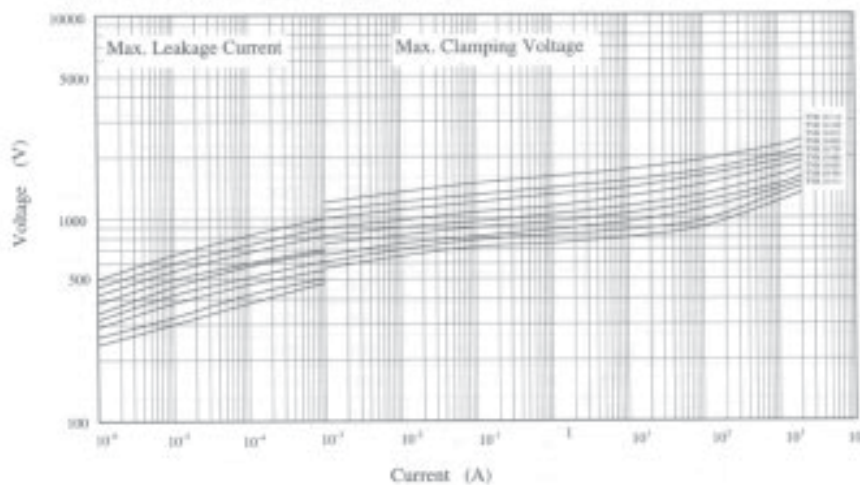



ZINC OXIDE VARISTOR 14Ø SERIES

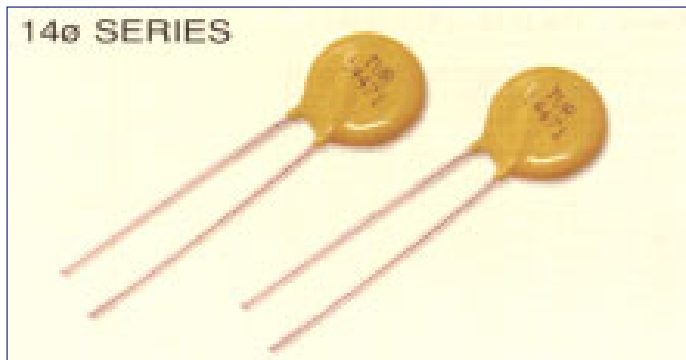

DIMENSION

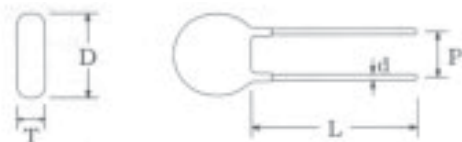

Unit: mm

Disc Ø	D max.	L min.	d nor.	P nor.
14	17	30	0.8±0.02	7.5±1

SPECIFICATION

Part No	Varistor Voltage			Max. Allowable Voltage		Max. Clamping Voltage		Max. Energy		Max. Peak Current (8/20µs)		Rated Power (W)	Reference Capacitance @1KHZ (pf)	Dimensions T(max.) (mm)
	VImA (V)	AC rms (V)	DC (V)	Vp (V)	Ip (A)	10/1000 (J)	1time (A)	2times (A)						
TVR 14 180	18	11	14	36	10	4.0	1000	500	0.1	22000	4.3			
TVR 14 220	22	14	18	43	10	5.0	1000	500	0.1	18000	4.5			
TVR 14 270	27	17	22	53	10	6.0	1000	500	0.1	12000	4.7			
TVR 14 330	33	20	26	65	10	7.5	1000	500	0.1	9000	4.9			
TVR 14 390	39	25	31	77	10	8.6	1000	500	0.1	7800	4.4			
TVR 14 470	47	30	38	93	10	10	1000	500	0.1	6600	4.5			
TVR 14 560	56	35	45	110	10	11	1000	500	0.1	5400	4.7			
TVR 14 680	68	40	56	135	10	14	1000	500	0.1	4500	5.0			
TVR 14 820	82	50	65	135	50	22	4500	2500	0.6	2900	4.4			
TVR 14 101	100	60	85	165	50	28	4500	2500	0.6	2400	4.6			
TVR 14 121	120	75	100	200	50	32	4500	2500	0.6	2000	4.8			
TVR 14 151	150	95	125	250	50	40	4500	2500	0.6	1600	5.1			
TVR 14 181	180	115	150	300	50	52	4500	2500	0.6	1300	4.6			
TVR 14 201	200	130	170	340	50	57	4500	2500	0.6	1000	4.7			
TVR 14 221	220	140	180	360	50	60	4500	2500	0.6	1000	4.8			
TVR 14 241	240	150	200	395	50	63	4500	2500	0.6	900	4.9			
TVR 14 271	270	175	225	455	50	70	4500	2500	0.6	750	5.1			
TVR 14 301	300	195	250	500	50	78	4500	2500	0.6	680	5.0			
TVR 14 331	330	215	275	550	50	85	4500	2500	0.6	620	5.1			
TVR 14 361	360	230	300	595	50	93	4500	2500	0.6	550	5.2			
TVR 14 391	390	250	320	650	50	100	4500	2500	0.6	520	5.4			
TVR 14 431	430	275	350	710	50	115	4500	2500	0.6	500	5.6			
TVR 14 471	470	300	385	775	50	125	4500	2500	0.6	480	5.7			
TVR 14 511	510	320	410	845	50	125	4500	2500	0.6	440	5.9			
TVR 14 561	560	350	450	930	50	125	4500	2500	0.6	400	6.1			
TVR 14 621	620	395	510	1020	50	125	4500	2500	0.6	330	6.4			
TVR 14 681	680	420	560	1120	50	130	4500	2500	0.6	320	6.7			
TVR 14 751	750	465	615	1235	50	143	4500	2500	0.6	310	7.0			
TVR 14 821	820	510	670	1355	50	157	4500	2500	0.6	280	6.9			
TVR 14 911	910	550	745	1500	50	175	4500	2500	0.6	250	7.3			
TVR 14 102	1000	625	825	1650	50	190	4500	2500	0.6	230	7.6			
TVR 14 112	1100	680	895	1815	50	213	4500	2500	0.6	210	8.1			



LIFE TIMES

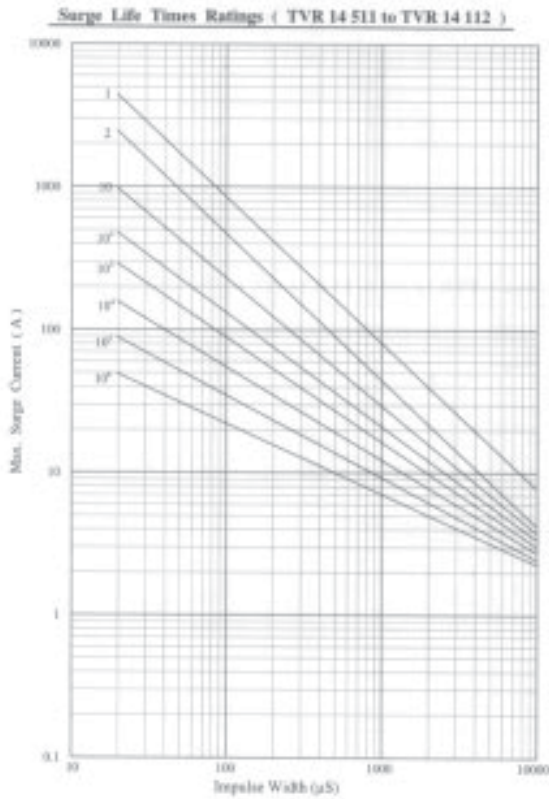
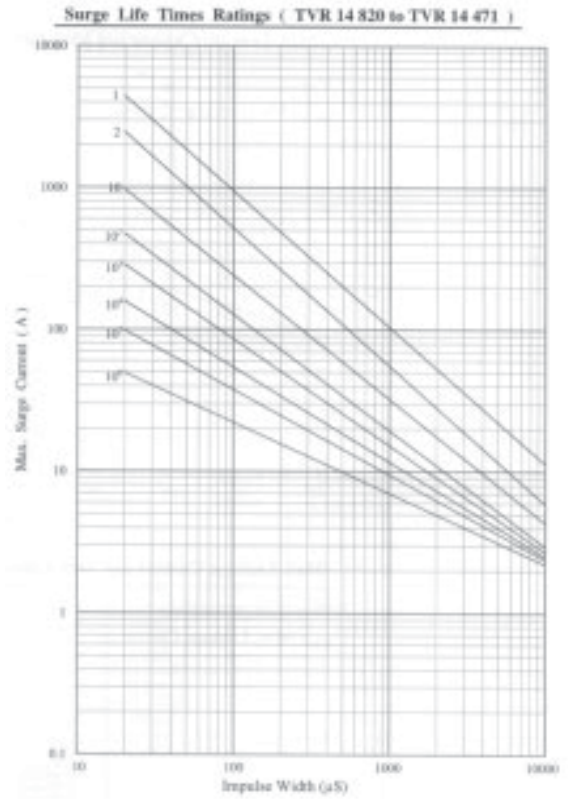
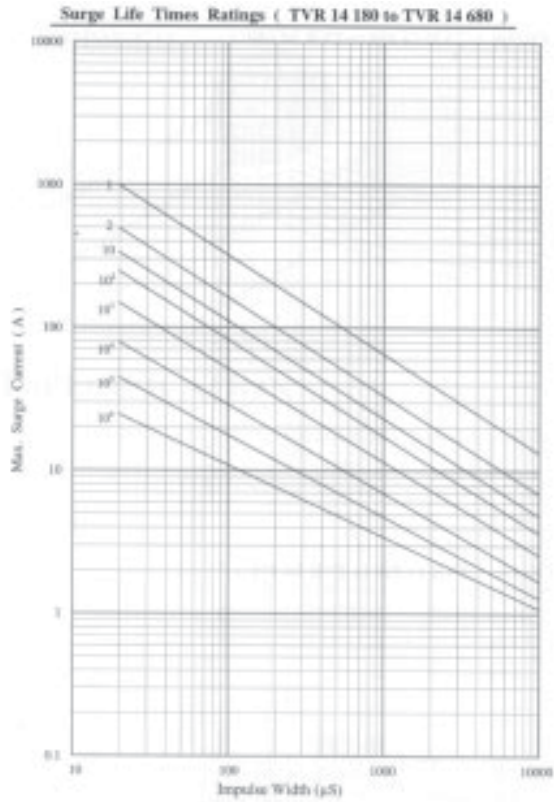

POWER DERATING CURVE

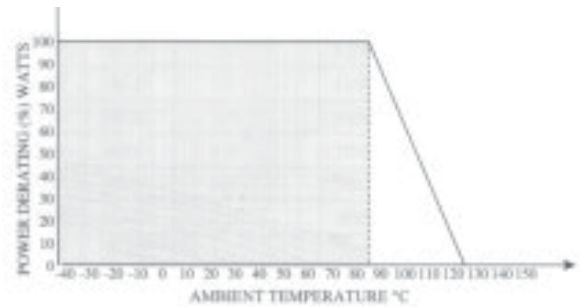



V-I CHARACTERISTIC CURVE

Max. Leakage Current and Max. Clamping Voltage Curves (TVR 14 180 to TVR 14 680)

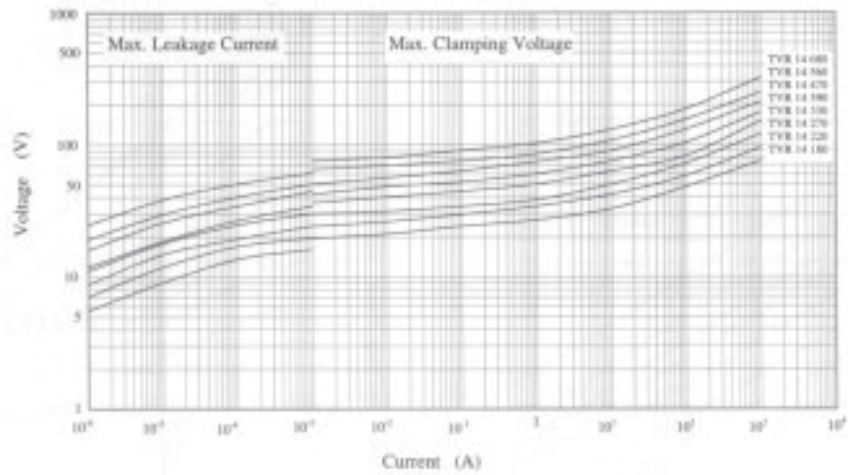

Max. Leakage Current and Max. Clamping Voltage Curves (TVR 14 820 to TVR 14 471)

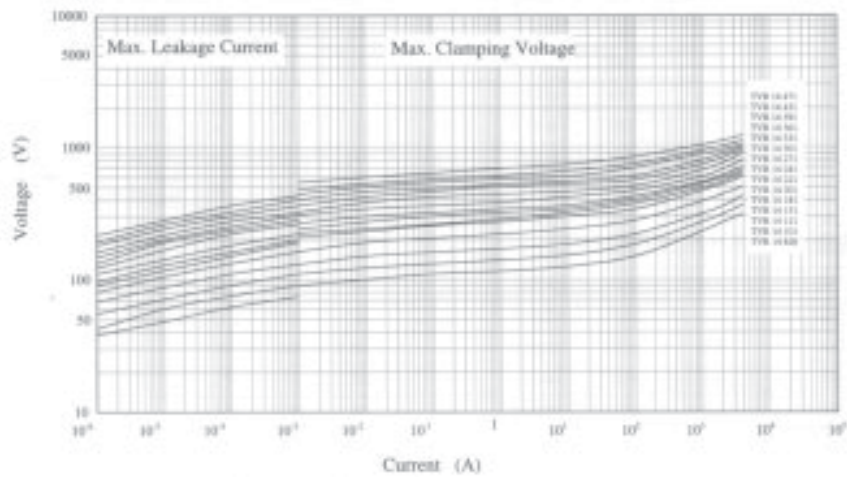

Max. Leakage Current and Max. Clamping Voltage Curves (TVR 14 511 to TVR 14 112)

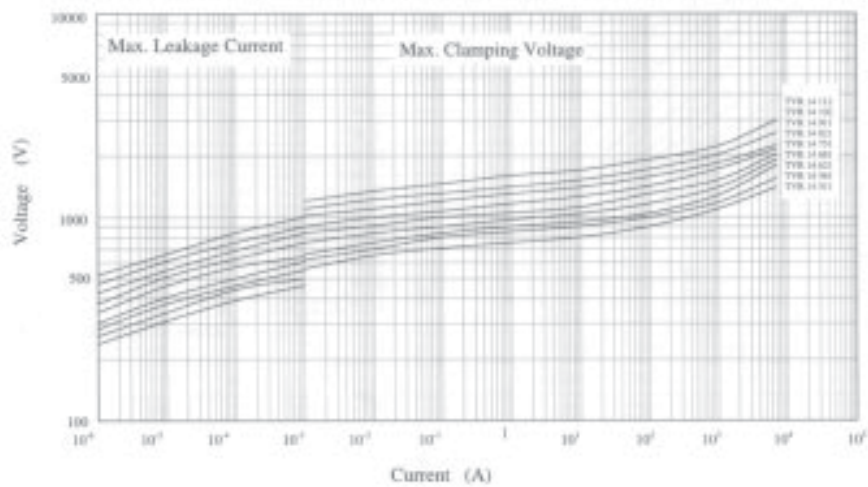



ZINC OXIDE VARISTOR 20Ø SERIES

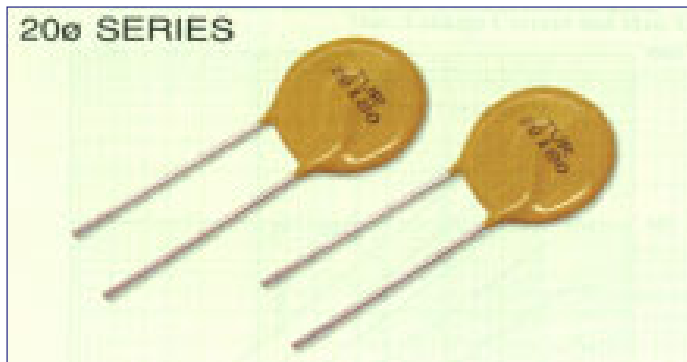

DIMENSION

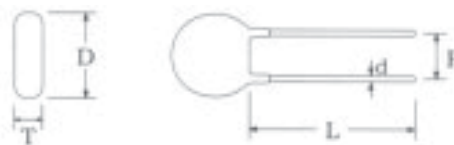

Unit: mm

Disc Ø	D max.	L min.	d nor.	P nor.
20	23.5	26	1.0±0.02	10±1

SPECIFICATION

Part No	Varistor Voltage			Max. Allowable Voltage		Max. Clamping Voltage		Max. Energy		Max. Peak Current (8/20µs)		Rated Power	Reference Capacitance	Dimensions
	VImA (V)	AC rms (V)	DC (V)	Vp (V)	Ip (A)	10/1000 (J)	1time (A)	2times (A)	(W)	@1KHZ (pf)	T(max.) (mm)			
TVR 20 180	18	11	14	36	20	11	2000	1000	0.2	44000	4.7			
TVR 20 220	22	14	18	43	20	14	2000	1000	0.2	36000	4.9			
TVR 20 270	27	17	22	53	20	18	2000	1000	0.2	26000	5.1			
TVR 20 330	33	20	26	65	20	23	2000	1000	0.2	20000	5.3			
TVR 20 390	39	25	31	77	20	26	2000	1000	0.2	18000	4.8			
TVR 20 470	47	30	38	93	20	33	2000	1000	0.2	15500	4.9			
TVR 20 560	56	35	45	110	20	41	2000	1000	0.2	13000	5.1			
TVR 20 680	68	40	56	135	20	46	2000	1000	0.2	10000	5.4			
TVR 20 820	82	50	65	135	100	48	6500	4000	1.0	6000	4.8			
TVR 20 101	100	60	85	165	100	51	6500	4000	1.0	5000	5.0			
TVR 20 121	120	75	100	200	100	55	6500	4000	1.0	4500	5.2			
TVR 20 151	150	95	125	250	100	70	6500	4000	1.0	3200	5.5			
TVR 20 181	180	115	150	300	100	84	6500	4000	1.0	2500	5.0			
TVR 20 201	200	130	170	340	100	95	6500	4000	1.0	2000	5.1			
TVR 20 221	220	140	180	360	100	100	6500	4000	1.0	2000	5.2			
TVR 20 241	240	150	200	395	100	108	6500	4000	1.0	1800	5.3			
TVR 20 271	270	175	225	455	100	127	6500	4000	1.0	1600	5.5			
TVR 20 301	300	195	250	500	100	136	6500	4000	1.0	1500	5.4			
TVR 20 331	330	215	275	550	100	150	6500	4000	1.0	1400	5.5			
TVR 20 361	360	230	300	595	100	163	6500	4000	1.0	1200	5.6			
TVR 20 391	390	250	320	650	100	180	6500	4000	1.0	1100	5.8			
TVR 20 431	430	275	350	710	100	190	6500	4000	1.0	1050	6.0			
TVR 20 471	470	300	385	775	100	220	6500	4000	1.0	950	6.1			
TVR 20 511	510	320	410	845	100	220	6500	4000	1.0	900	6.3			
TVR 20 561	560	350	450	930	100	220	6500	4000	1.0	800	6.5			
TVR 20 621	620	395	510	1020	100	220	6500	4000	1.0	700	6.8			
TVR 20 681	680	420	560	1120	100	230	6500	4000	1.0	650	7.1			
TVR 20 751	750	465	615	1235	100	255	6500	4000	1.0	600	7.4			
TVR 20 821	820	510	670	1355	100	282	6500	4000	1.0	530	7.3			
TVR 20 911	910	550	745	1500	100	310	6500	4000	1.0	500	7.7			
TVR 20 102	1000	625	825	1650	100	342	6500	4000	1.0	450	8.1			
TVR 20 112	1100	680	895	1815	100	383	6500	4000	1.0	400	8.5			





LIFE TIMES

Surge Life Times Ratings (TVR 20 180 to TVR 20 680)

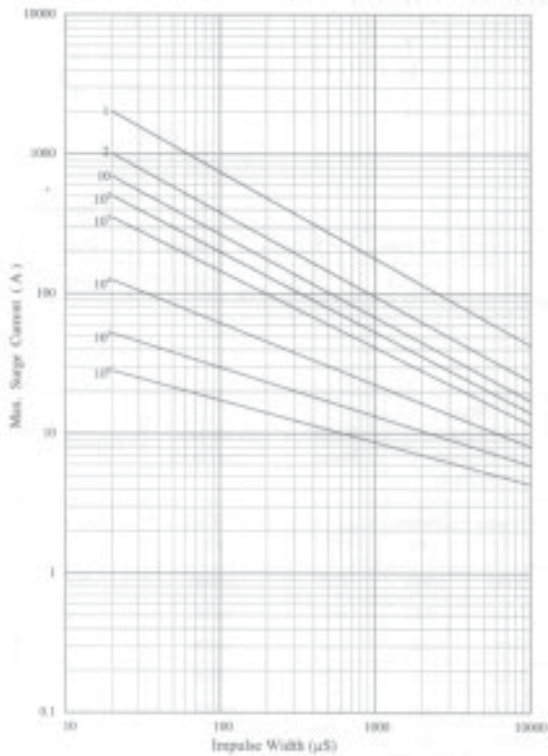

Surge Life Times Ratings (TVR 20 820 to TVR 20 471)

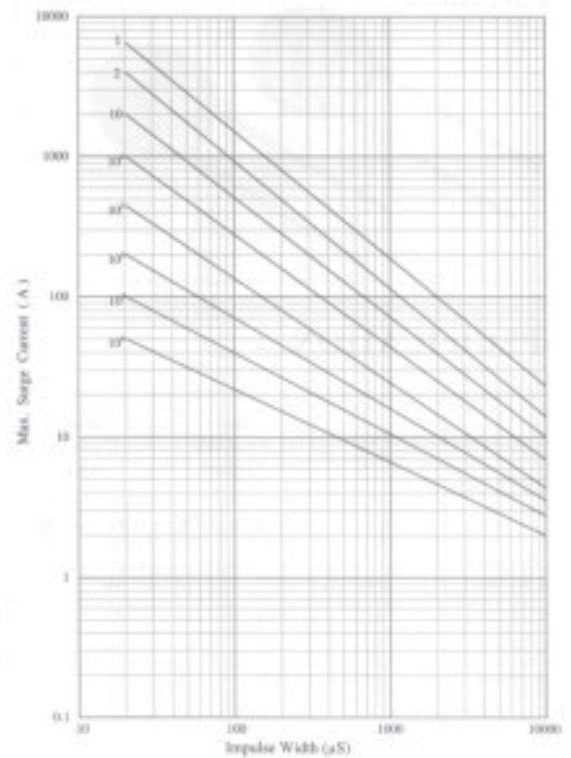

Surge Life Times Ratings (TVR 20 511 to TVR 20 112)

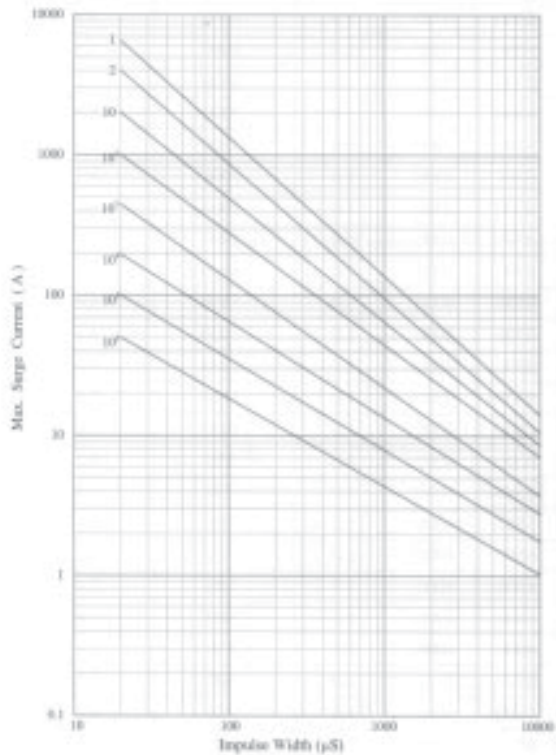

POWER DERATING CURVE

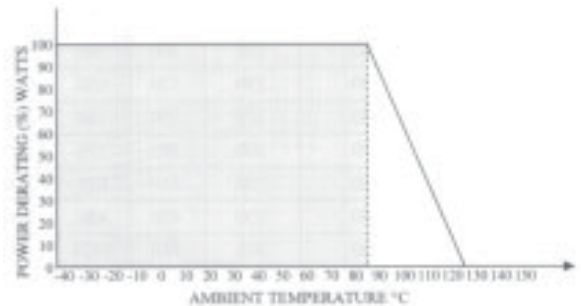



V-I CHARACTERISTIC CURVE

Max. Leakage Current and Max. Clamping Voltage Curves (TVR 20 180 to TVR 20 680)

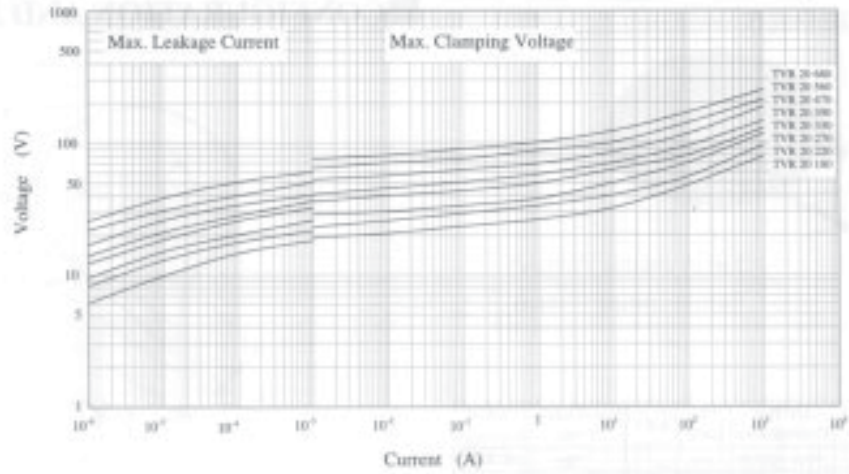

Max. Leakage Current and Max. Clamping Voltage Curves (TVR 20 820 to TVR 20 471)

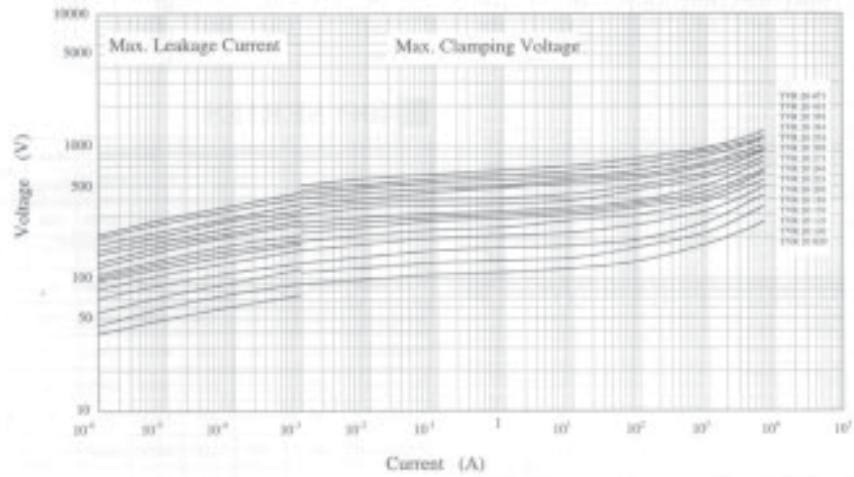

Max. Leakage Current and Max. Clamping Voltage Curves (TVR 20 511 to TVR 20 112)

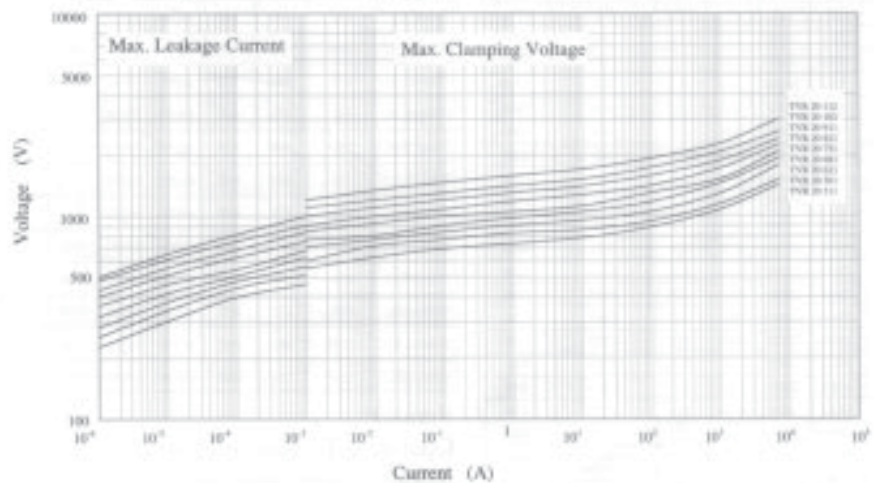



ZINC OXIDE VARISTOR G SERIES

TVR G TYPE

250/320/400 SERIES



Epoxy coating (Yellow)
Silicon coating (Green)

250 SERIES

Part Number	Normal Varistor Voltage VmA(V)	Max. Allowable voltage		Max. Peak Current(8/20µs)		Max. Energy 2ms (J)	Max. Rated Power (W)	Max. Clamping Voltage V150A (V)	Typical Capacitance @1KHZ (PF)
		ACrms (V)	DC (V)	1time (A)	2times (A)				
TVR25201KG	200	130	170	15000	10000	128	1.0	340	2200
TVR25221KG	220	140	180	15000	10000	135	1.0	365	2000
TVR25241KG	240	150	200	15000	10000	146	1.0	395	1900
TVR25271KG	270	175	225	15000	10000	170	1.0	455	1600
TVR25361KG	360	230	300	15000	10000	190	1.0	595	1300
TVR25391KG	390	250	320	15000	10000	210	1.0	650	1100
TVR25431KG	430	275	350	15000	10000	220	1.0	710	1000
TVR25471KG	470	300	385	15000	10000	225	1.0	775	950
TVR25511KG	510	320	415	15000	10000	230	1.0	845	900
TVR25561KG	560	350	450	15000	10000	235	1.0	930	800
TVR25621KG	620	385	505	15000	10000	240	1.0	1025	700
TVR25681KG	680	420	560	15000	10000	250	1.0	1120	650
TVR25751KG	750	460	615	15000	10000	275	1.0	1240	600
TVR25781KG	780	485	640	15000	10000	290	1.0	1290	550
TVR25821KG	820	510	670	15000	10000	300	1.0	1355	520
TVR25911KG	910	550	745	15000	10000	340	1.0	1500	500
TVR25951KG	950	575	765	15000	10000	355	1.0	1570	450
TVR25102KG	1000	625	825	15000	10000	375	1.0	1650	430
TVR25112KG	1100	680	895	15000	10000	390	1.0	1815	400

320 SERIES

Part Number	Normal Varistor Voltage VmA(V)	Max. Allowable voltage		Max. Peak Current(8/20µs)		Max. Energy 2ms (J)	Max. Rated Power (W)	Max. Clamping Voltage V200A (V)	Typical Capacitance @1KHZ (PF)
		ACrms (V)	DC (V)	1time (A)	2times (A)				
TVR32201KG	200	130	170	25000	20000	210	1.2	340	3900
TVR32221KG	220	140	180	25000	20000	225	1.2	365	3500
TVR32241KG	240	150	200	25000	20000	240	1.2	395	3300
TVR32271KG	270	175	225	25000	20000	250	1.2	455	2800
TVR32361KG	360	230	300	25000	20000	300	1.2	595	2200
TVR32391KG	390	250	320	25000	20000	330	1.2	650	2000
TVR32431KG	430	275	350	25000	20000	360	1.2	710	1800
TVR32471KG	470	300	385	25000	20000	405	1.2	775	1700
TVR32511KG	510	320	415	25000	20000	430	1.2	845	1600
TVR32561KG	560	350	450	25000	20000	470	1.2	930	1400
TVR32621KG	620	385	505	25000	20000	550	1.2	1025	1250
TVR32681KG	680	420	560	25000	20000	600	1.2	1120	1150
TVR32751KG	750	460	615	25000	20000	660	1.2	1240	1100
TVR32781KG	780	485	640	25000	20000	680	1.2	1290	1050
TVR32821KG	820	510	670	25000	20000	550	1.2	1355	950
TVR32911KG	910	550	745	25000	20000	620	1.2	1500	900
TVR32951KG	950	575	765	25000	20000	660	1.2	1570	850
TVR32102KG	1000	625	825	25000	20000	690	1.2	1650	800
TVR32112KG	1100	680	895	25000	20000	760	1.2	1815	750
TVR32122KG	1200	750	1060	25000	20000	800	1.2	2000	650

CONFIGURATION AND DIMENSION

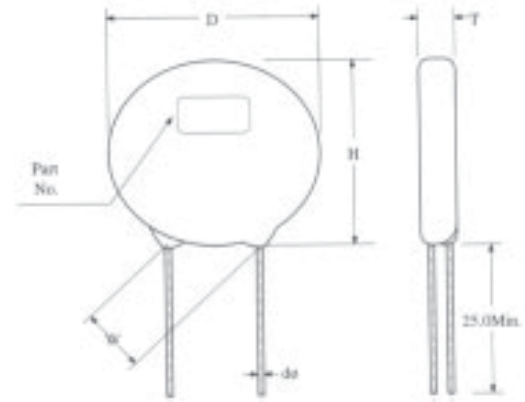

Unit: mm

Disc Ø	D max.	T max.	W	H max.	dØ±0.02
25	29	10	10±1	33	1.0
32	36	10	15±1	40	1.5
40	44	12	20±1	48	1.5

400 SERIES

Part Number	Normal Varistor Voltage VmA(V)	Max. Allowable voltage		Max. Peak Current(8/20µs)		Max. Energy 2ms (J)	Max. Rated Power (W)	Max. Clamping Voltage V300A (V)	Typical Capacitance @1KHZ (PF)
		ACrms (V)	DC (V)	1time (A)	2times (A)				
TVR40201KG	200	130	170	40000	30000	320	1.4	340	6000
TVR40221KG	220	140	180	40000	30000	340	1.4	365	5500
TVR40241KG	240	150	200	40000	30000	360	1.4	395	5000
TVR40271KG	270	175	225	40000	30000	400	1.4	455	4500
TVR40361KG	360	230	300	40000	30000	460	1.4	595	3500
TVR40391KG	390	250	320	40000	30000	490	1.4	650	3000
TVR40431KG	430	275	350	40000	30000	550	1.4	710	2800
TVR40471KG	470	300	385	40000	30000	595	1.4	775	2600
TVR40511KG	510	320	415	40000	30000	640	1.4	845	2500
TVR40561KG	560	350	450	40000	30000	700	1.4	930	2200
TVR40621KG	620	385	505	40000	30000	800	1.4	1025	2000
TVR40681KG	680	420	560	40000	30000	910	1.4	1120	1800
TVR40751KG	750	460	615	40000	30000	1000	1.4	1240	1700
TVR40781KG	780	485	640	40000	30000	1030	1.4	1290	1600
TVR40821KG	820	510	670	40000	30000	860	1.4	1355	1500
TVR40911KG	910	550	745	40000	30000	960	1.4	1500	1400
TVR40951KG	950	575	765	40000	30000	1000	1.4	1570	1300
TVR40102KG	1000	625	825	40000	30000	1050	1.4	1650	1200
TVR40112KG	1100	680	895	40000	30000	1150	1.4	1815	1100
TVR40122KG	1200	750	1060	40000	30000	1250	1.4	2000	1000

Remark:
Operating Temperature: -40-85°C
Storage Temperature: -40-110°C





LIFE TIMES

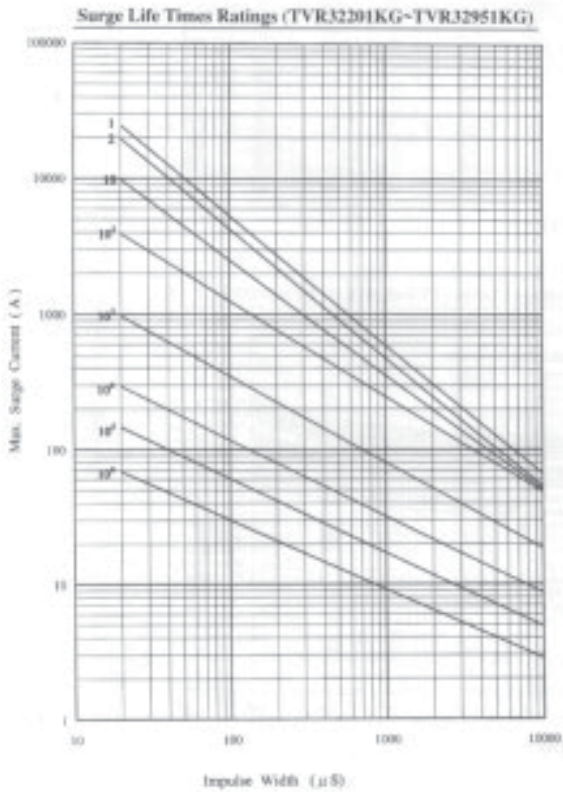
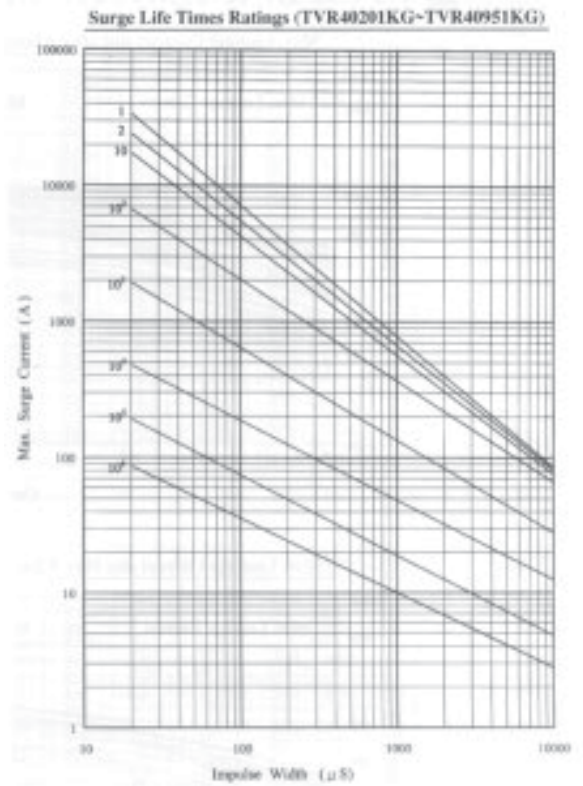
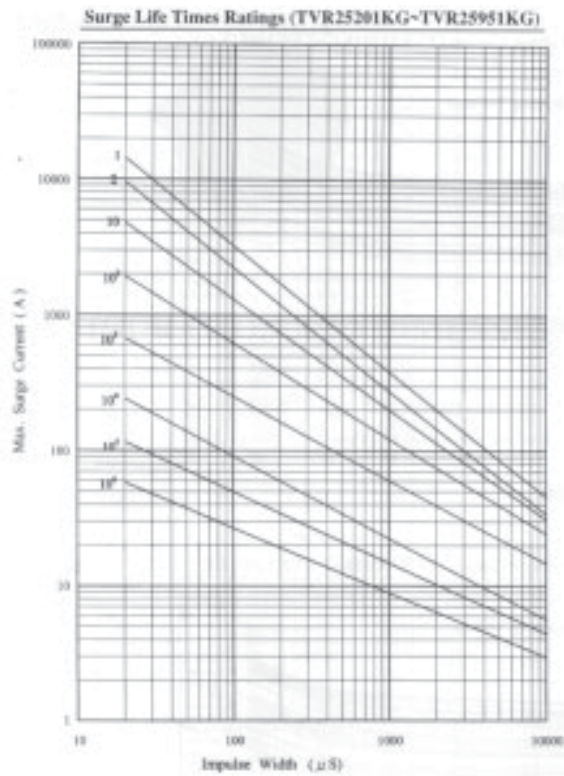

POWER DERATING CURVE

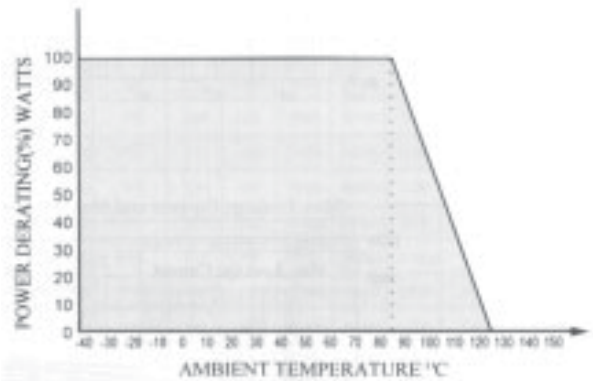



V-I CHARACTERISTIC CURVE

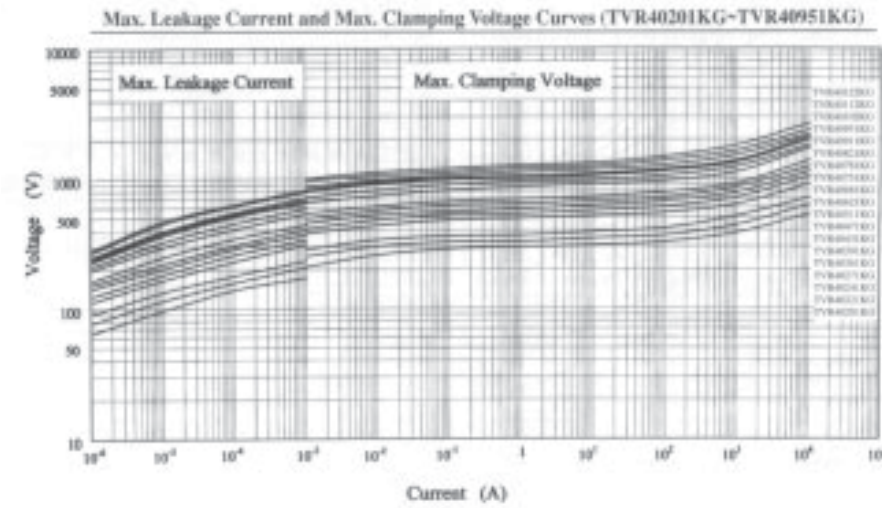
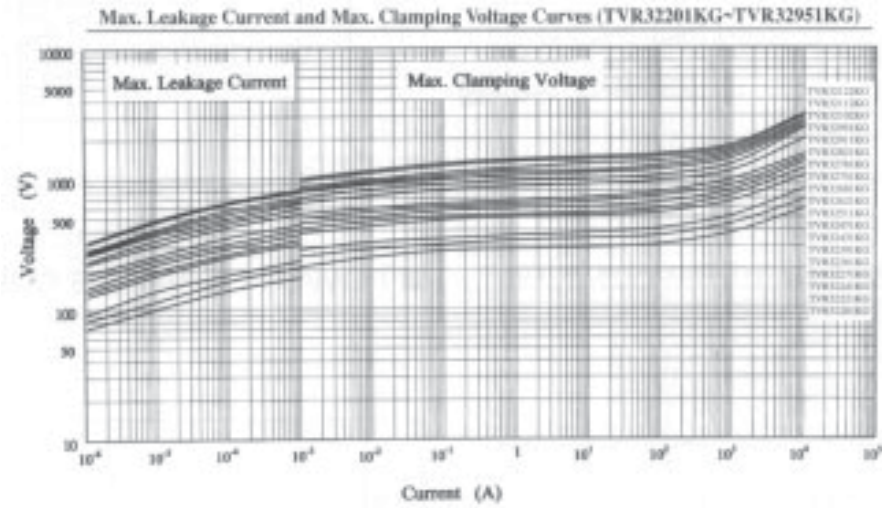
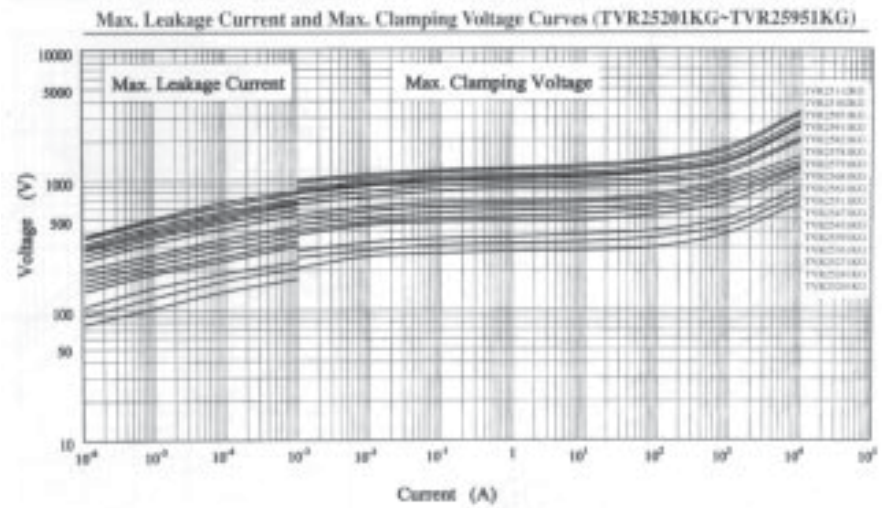



ZINC OXIDE VARISTOR Q SERIES

TVR Q TYPE

320/400/600 SERIES



Epoxy coating (Yellow)
Silicon coating (Green)

CONFIGURATION AND DIMENSION

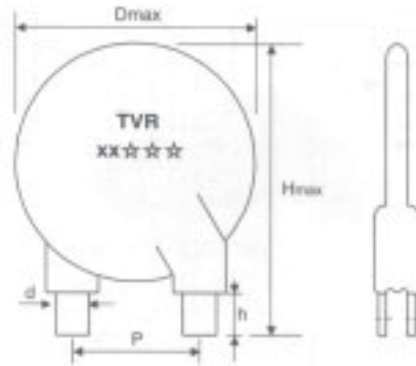

the leads with screw holes are available as per photo above.

Unit: mm

Disc Ø	D max.	H max	P±0.5	d±0.2	hmin
32	36	41	25	7.0	10
40	44	48	25	7.0	10
60	63	78	25	9.5	--

Part Number	Normal Varistor Voltage VImA(V)	Max. Allowable voltage		Max. Peak Current(8/20µs)			Max. Energy (J)	Max. Rated Power (W)	Max. Clamping Voltage V200A (V)	Typical Capacitance @1KHZ (PF)
		ACrms (V)	DC (V)	1time (A)	2times (A)	2ms (A)				
TVR32201KQ	200	130	170	25000	20000	210	1.2	340	3900	
TVR32221KQ	220	140	180	25000	20000	225	1.2	365	3500	
TVR32241KQ	240	150	200	25000	20000	240	1.2	395	3300	
TVR32271KQ	270	175	225	25000	20000	255	1.2	455	2800	
TVR32361KQ	360	230	300	25000	20000	300	1.2	595	2200	
TVR32391KQ	390	250	320	25000	20000	330	1.2	650	2000	
TVR32431KQ	430	275	350	25000	20000	360	1.2	710	1800	
TVR32471KQ	470	300	385	25000	20000	405	1.2	775	1700	
TVR32511KQ	510	320	415	25000	20000	430	1.2	845	1600	
TVR32561KQ	560	340	450	25000	20000	470	1.2	930	1400	
TVR32621KQ	620	385	505	25000	20000	550	1.2	1025	1250	
TVR32681KQ	680	420	560	25000	20000	600	1.2	1120	1150	
TVR32751KQ	750	460	615	25000	20000	660	1.2	1240	1100	
TVR32781KQ	780	485	640	25000	20000	680	1.2	1290	1050	
TVR32821KQ	820	510	670	25000	20000	550	1.2	1355	950	
TVR32911KQ	910	550	745	25000	20000	620	1.2	1500	900	
TVR32951KQ	950	575	765	25000	20000	660	1.2	1570	850	
TVR32112KQ	1100	680	895	25000	20000	760	1.2	1815	750	
TVR32122KQ	1200	750	1060	25000	20000	800	1.2	2000	650	

Part Number	Normal Varistor Voltage VImA(V)	Max. Allowable voltage		Max. Peak Current(8/20µs)			Max. Energy (J)	Max. Rated Power (W)	Max. Clamping Voltage V300A (V)	Typical Capacitance @1KHZ (PF)
		ACrms (V)	DC (V)	1time (A)	2times (A)	2ms (A)				
TVR40201KQ	200	130	170	40000	30000	310	1.4	340	6000	
TVR40221KQ	220	140	180	40000	30000	340	1.4	365	5500	
TVR40241KQ	240	150	200	40000	30000	360	1.4	395	5000	
TVR40271KQ	270	175	225	40000	30000	400	1.4	455	4500	
TVR40361KQ	360	230	300	40000	30000	460	1.4	595	3500	
TVR40391KQ	390	250	320	40000	30000	490	1.4	650	3000	
TVR40431KQ	430	275	350	40000	30000	550	1.4	710	2800	
TVR40471KQ	470	300	385	40000	30000	595	1.4	775	2600	
TVR40511KQ	510	320	415	40000	30000	640	1.4	845	2500	
TVR40561KQ	560	350	450	40000	30000	710	1.4	930	2200	
TVR40621KQ	620	385	505	40000	30000	800	1.4	1025	2000	
TVR40681KQ	680	420	560	40000	30000	910	1.4	1120	1800	
TVR40751KQ	750	460	615	40000	30000	1000	1.4	1240	1700	
TVR40781KQ	780	485	640	40000	30000	1030	1.4	1290	1600	
TVR40821KQ	820	510	670	40000	30000	860	1.4	1355	1500	
TVR40911KQ	910	550	745	40000	30000	960	1.4	1500	1400	
TVR40951KQ	950	575	765	40000	30000	1000	1.4	1570	1300	
TVR40112KQ	1100	680	895	40000	30000	1100	1.4	1815	1100	
TVR40122KQ	1200	750	1060	40000	30000	1200	1.4	2000	1000	

Part Number	Normal Varistor Voltage VImA(V)	Max. Allowable voltage		Max. Peak Current(8/20µs)			Max. Energy (J)	Max. Rated Power (W)	Max. Clamping Voltage V500A (V)	Typical Capacitance @1KHZ (PF)
		ACrms (V)	DC (V)	1time (A)	2times (A)	2ms (A)				
TVR60391KQ	390	250	320	70000	40000	800	1.6	650	7200	
TVR60431KQ	430	275	350	70000	40000	860	1.6	710	6600	
TVR60471KQ	470	300	385	70000	40000	950	1.6	775	6100	
TVR60511KQ	510	320	415	70000	40000	1000	1.6	845	5800	
TVR60561KQ	560	350	450	70000	40000	1100	1.6	930	5100	
TVR60621KQ	620	385	505	70000	40000	1200	1.6	1025	4600	
TVR60681KQ	680	420	560	70000	40000	1500	1.6	1120	4300	
TVR60751KQ	750	460	615	70000	40000	1650	1.6	1240	4100	
TVR60781KQ	780	485	640	70000	40000	1700	1.6	1290	3800	
TVR60821KQ	820	510	670	70000	40000	1350	1.6	1355	3600	
TVR60911KQ	910	550	745	70000	40000	1500	1.6	1570	3300	
TVR60951KQ	950	575	765	70000	40000	1560	1.6	1650	3000	
TVR60112KQ	1100	680	895	70000	40000	1800	1.6	1815	2700	
TVR60122KQ	1200	750	1060	70000	40000	2000	1.6	2000	2500	
TVR60182KQ	1800	1000	1465	70000	40000	3000	1.6	2970	1800	

Remark:

Operating Temperature: -40-85°C

Storage Temperature: -40-110°C

PART NUMBER CODE

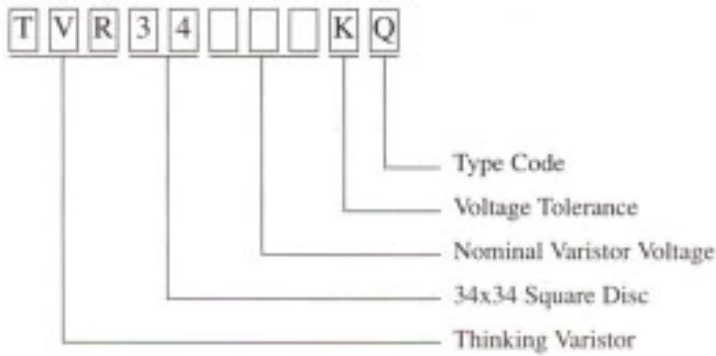

CONFIGURATION AND DIMENSION

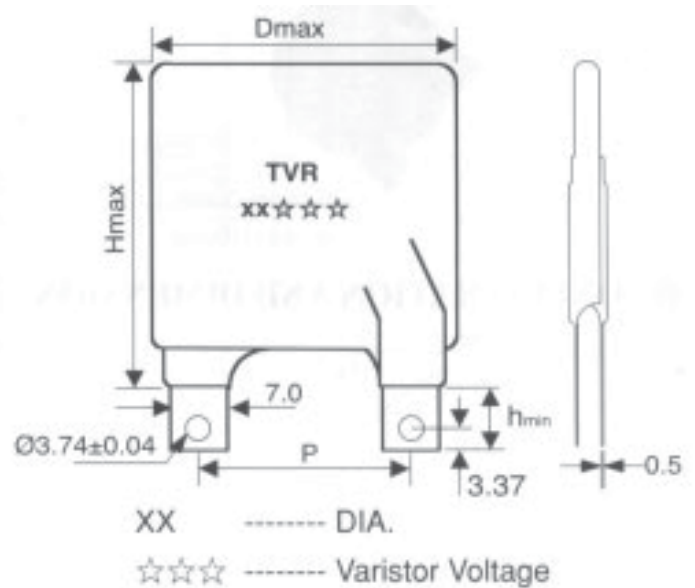

Unit: mm				
Disc Ø	D max.	H max.	h min.	P±0.5
34	38	43	10	25

Part Number	Normal Varistor Voltage VImA(V)	Max. Allowable voltage		Max. Peak Current(8/20µs)		Max. Energy 2ms (J)	Rated Power (W)	Max. Clamping Voltage V300A (V)	Typical Capacitance @1KHZ (PF)
		ACrms (V)	DC (V)	1time (A)	2times (A)				
TVR34201KQ	200	130	170	40,000	30,000	310	1.4	340	5600
TVR34221KQ	220	140	180	40,000	30,000	340	1.4	360	5000
TVR34241KQ	240	150	200	40,000	30,000	360	1.4	395	4800
TVR34271KQ	270	175	225	40,000	30,000	400	1.4	455	4100
TVR34361KQ	360	230	300	40,000	30,000	460	1.4	595	3200
TVR34391KQ	390	250	320	40,000	30,000	490	1.4	650	2800
TVR34431KQ	430	275	350	40,000	30,000	550	1.4	710	2600
TVR34471KQ	470	300	385	40,000	30,000	595	1.4	775	2400
TVR34511KQ	510	320	410	40,000	30,000	640	1.4	845	2300
TVR34561KQ	560	350	450	40,000	30,000	710	1.4	930	2000
TVR34621KQ	620	385	505	40,000	30,000	800	1.4	1025	1800
TVR34681KQ	680	420	560	40,000	30,000	910	1.4	1120	1700
TVR34751KQ	750	460	615	40,000	30,000	1000	1.4	1235	1600
TVR34781KQ	780	485	640	40,000	30,000	1030	1.4	1240	1500
TVR34821KQ	820	510	670	40,000	30,000	860	1.4	1355	1400
TVR34911KQ	910	550	745	40,000	30,000	960	1.4	1500	1300
TVR34951KQ	950	575	765	40,000	30,000	1000	1.4	1570	1200
TVR34102KQ	1000	625	825	40,000	30,000	1050	1.4	1650	1100
TVR34112KQ	1100	680	895	40,000	30,000	1200	1.4	1815	1050
TVR34122KQ	1200	750	1060	40,000	30,000	1310	1.4	2000	950

PART NUMBER CODE

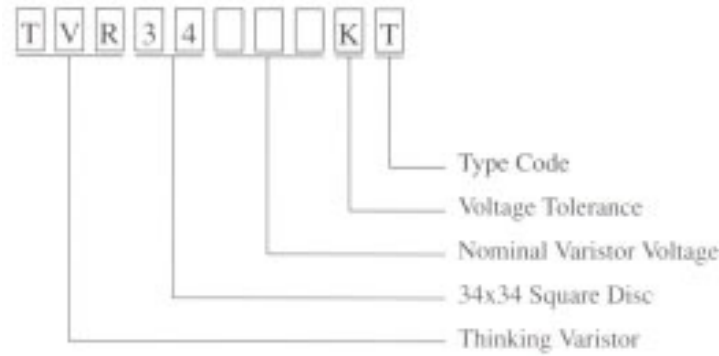

CONFIGURATION AND DIMENSION

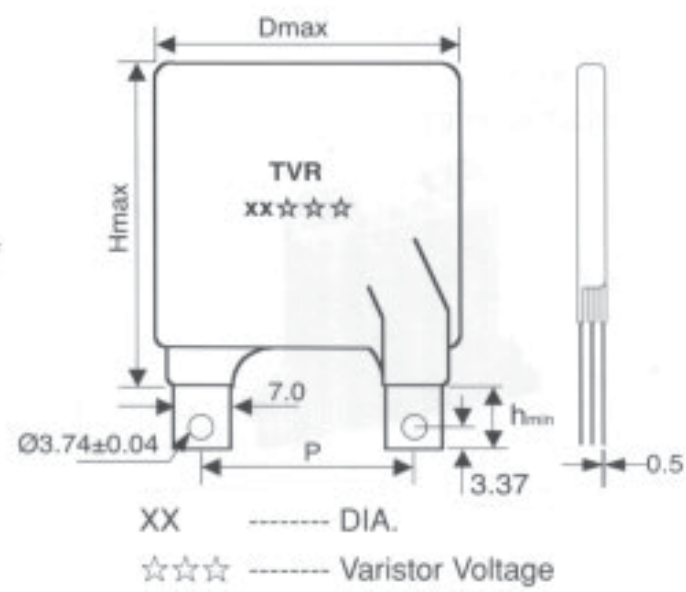

Unit: mm				
Disc Ø	D max.	H max.	h min.	P±0.5
34	38	43	10	25

Part Number	Normal Varistor Voltage VImA(V)	Max. Allowable voltage		Max. Peak Current(8/20µs)		Max. Energy 2ms (J)	Rated Power (W)	Max. Clamping Voltage V500A (V)	Typical Capacitance @1KHZ (PF)
		ACrms	DC	1time	2times				
		(V)	(V)	(A)	(A)				
TVR34201KT	200	130	170	70,000	40,000	410	1.6	340	14040
TVR34221KT	220	140	180	70,000	40,000	451	1.6	360	12760
TVR34241KT	240	150	200	70,000	40,000	490	1.6	395	11700
TVR34271KT	270	175	225	70,000	40,000	550	1.6	455	10400
TVR34361KT	360	230	300	70,000	40,000	730	1.6	595	7800
TVR34391KT	390	250	320	70,000	40,000	800	1.6	650	7200
TVR34431KT	430	275	350	70,000	40,000	860	1.6	710	6600
TVR34471KT	470	300	385	70,000	40,000	950	1.6	775	6100
TVR34511KT	510	320	410	70,000	40,000	1000	1.6	845	5800
TVR34561KT	560	350	450	70,000	40,000	1100	1.6	930	5100
TVR34621KT	620	385	505	70,000	40,000	1200	1.6	1025	4600
TVR34681KT	680	420	560	70,000	40,000	1500	1.6	1120	4300
TVR34751KT	750	460	615	70,000	40,000	1650	1.6	1240	4100
TVR34781KT	780	485	640	70,000	40,000	1700	1.6	1290	3800
TVR34821KT	820	510	670	70,000	40,000	1350	1.6	1355	3600
TVR34911KT	910	550	745	70,000	40,000	1500	1.6	1500	3300
TVR34951KT	950	575	765	70,000	40,000	1560	1.6	1570	3000
TVR34102KT	1000	625	825	70,000	40,000	1650	1.6	1650	2900
TVR34112KT	1100	680	895	70,000	40,000	1800	1.6	1815	2700
TVR34122KT	1200	750	1060	70,000	40,000	2000	1.6	2000	2500

Note: The two terminals at the same side of the products must be connected together in applications.



ZINC OXIDE VARISTOR B SERIES

TVR B TYPE

CONFIGURATION AND DIMENSION

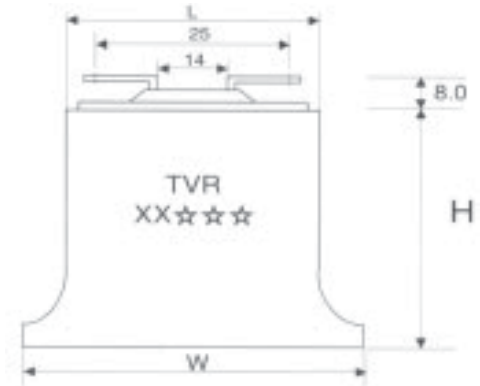

Unit: mm

Disc Ø	W ± 1	H ± 1	L ± 1
25	62	48	42
32	62	48	42

250 SERIES

Part Number	Normal Varistor Voltage	Max. Allowable voltage		Max. Peak Current(8/20µs)		Max. Energy 2ms	Max. Rated Power	Max. Clamping Voltage V300A	Typical Capacitance @1KHZ
		ACrms	DC	1time	2times				
		VimA(V)	(V)	(A)	(A)				
TVR25201KB	200	130	170	15000	10000	128	1.0	340	2200
TVR25221KB	220	140	180	15000	10000	135	1.0	365	2000
TVR25241KB	240	150	200	15000	10000	146	1.0	395	1900
TVR25271KB	270	175	225	15000	10000	170	1.0	455	1600
TVR25361KB	360	230	300	15000	10000	190	1.0	595	1300
TVR25391KB	390	250	320	15000	10000	210	1.0	650	1100
TVR25431KB	430	275	350	15000	10000	220	1.0	710	1000
TVR25471KB	470	300	385	15000	10000	225	1.0	775	950
TVR25511KB	510	320	415	15000	10000	230	1.0	845	900
TVR25561KB	560	350	450	15000	10000	235	1.0	930	800
TVR25621KB	620	385	505	15000	10000	240	1.0	1025	700
TVR25681KB	680	420	560	15000	10000	250	1.0	1120	650
TVR25751KB	750	460	615	15000	10000	275	1.0	1240	600
TVR25781KB	780	485	640	15000	10000	290	1.0	1290	550
TVR25821KB	820	510	670	15000	10000	300	1.0	1355	520
TVR25911KB	910	550	745	15000	10000	340	1.0	1500	500
TVR25951KB	950	575	765	15000	10000	355	1.0	1570	450
TVR25102KB	1000	625	825	15000	10000	375	1.0	1650	430
TVR25112KB	1100	680	895	15000	10000	390	1.0	1815	400

Remark:
 Operating Temperature: -40~85°C
 Storage Temperature: -40~110°C

320 SERIES

Part Number	Normal Varistor Voltage	Max. Allowable voltage		Max. Peak Current(8/20µs)		Max. Energy 2ms	Max. Rated Power	Max. Clamping Voltage V300A	Typical Capacitance @1KHZ
		ACrms	DC	1time	2times				
		VimA(V)	(V)	(A)	(A)				
TVR32201KB	200	130	170	25000	20000	210	1.2	340	3900
TVR32221KB	220	140	180	25000	20000	225	1.2	365	3500
TVR32241KB	240	150	200	25000	20000	240	1.2	395	3300
TVR32271KB	270	175	225	25000	20000	255	1.2	455	2800
TVR32361KB	360	230	300	25000	20000	300	1.2	595	2200
TVR32391KB	390	250	320	25000	20000	330	1.2	650	2000
TVR32431KB	430	275	350	25000	20000	360	1.2	710	1800
TVR32471KB	470	300	385	25000	20000	405	1.2	775	1700
TVR32511KB	510	320	415	25000	20000	430	1.2	845	1600
TVR32561KB	560	350	450	25000	20000	470	1.2	930	1400
TVR32621KB	620	385	505	25000	20000	550	1.2	1025	1250
TVR32681KB	680	420	560	25000	20000	600	1.2	1120	1150
TVR32751KB	750	460	615	25000	20000	660	1.2	1240	1100
TVR32781KB	780	485	640	25000	20000	680	1.2	1290	1050
TVR32821KB	820	510	670	25000	20000	555	1.2	1355	950
TVR32911KB	910	550	745	25000	20000	620	1.2	1500	900
TVR32951KB	950	575	765	25000	20000	660	1.2	1570	850
TVR32102KB	1000	625	825	25000	20000	690	1.2	1650	800
TVR32112KB	1100	680	895	25000	20000	760	1.2	1815	750
TVR32122KB	1200	750	1060	25000	20000	800	1.2	2000	650





LIFE TIMES

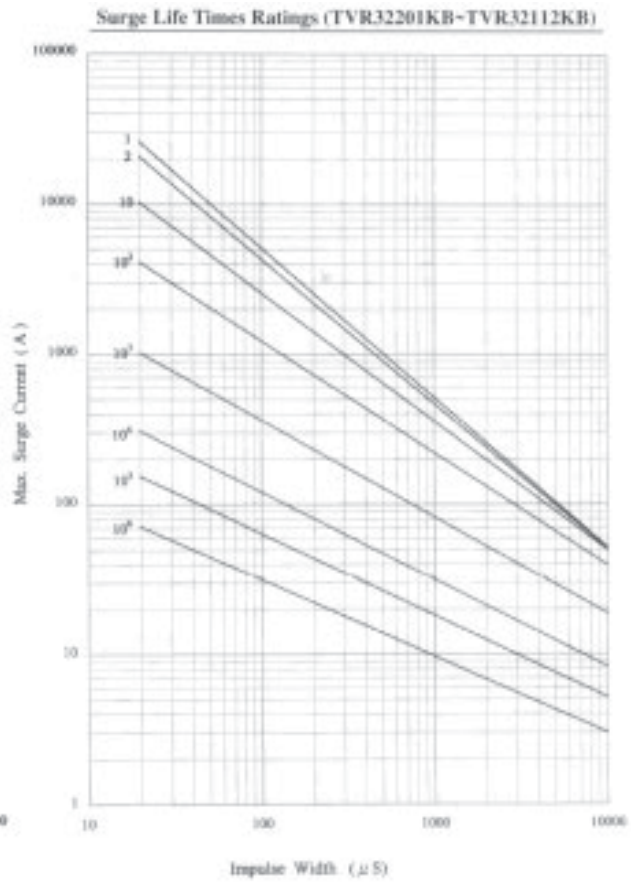
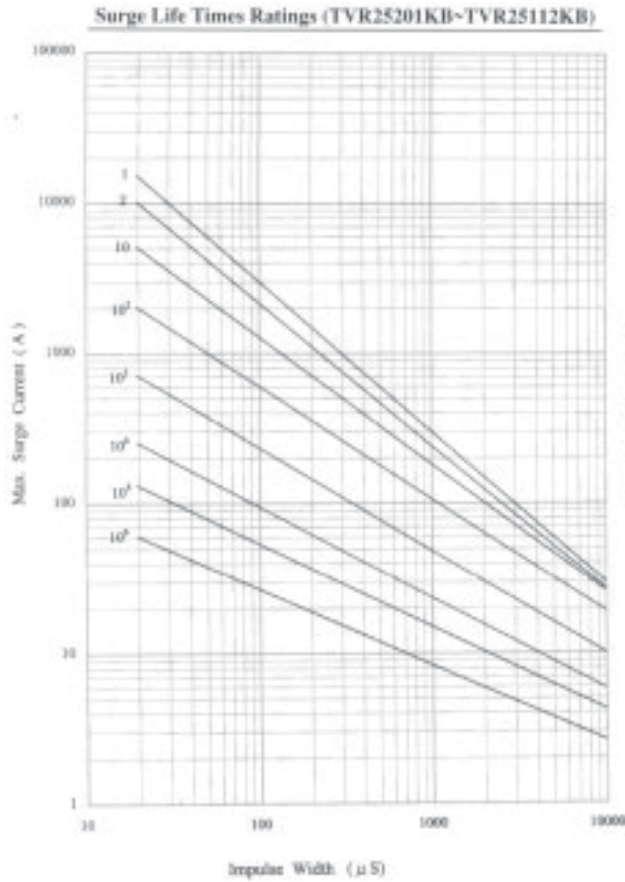

POWER DERATING CURVE

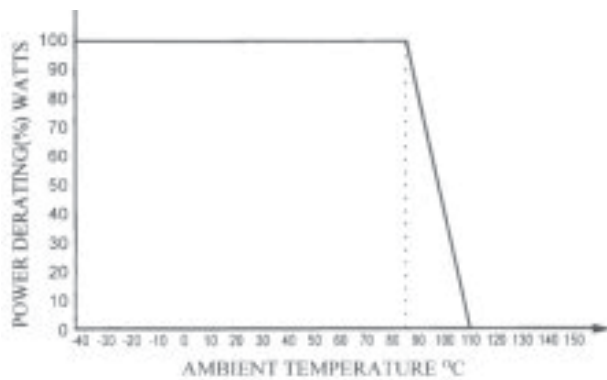



V-I CHARACTERISTIC CURVE

Max. Leakage Current and Max. Clamping Voltage Curves (TVR25201KB~TVR25112KB)

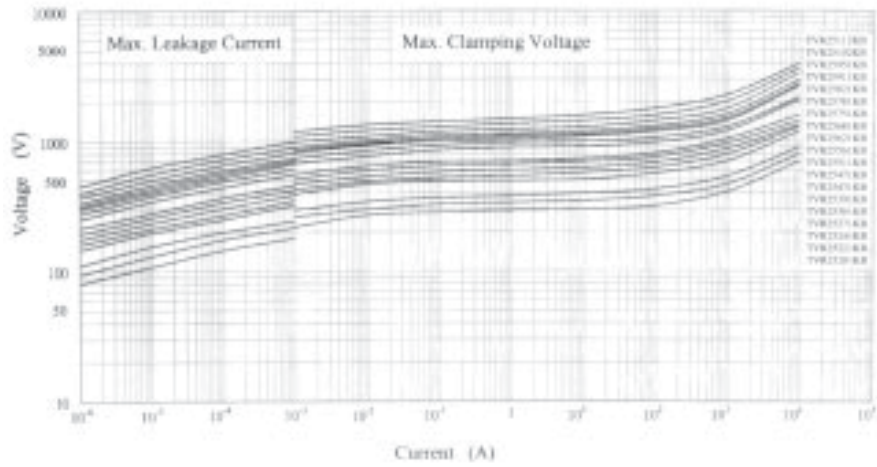

Max. Leakage Current and Max. Clamping Voltage Curves (TVR32201KB~TVR32112KB)

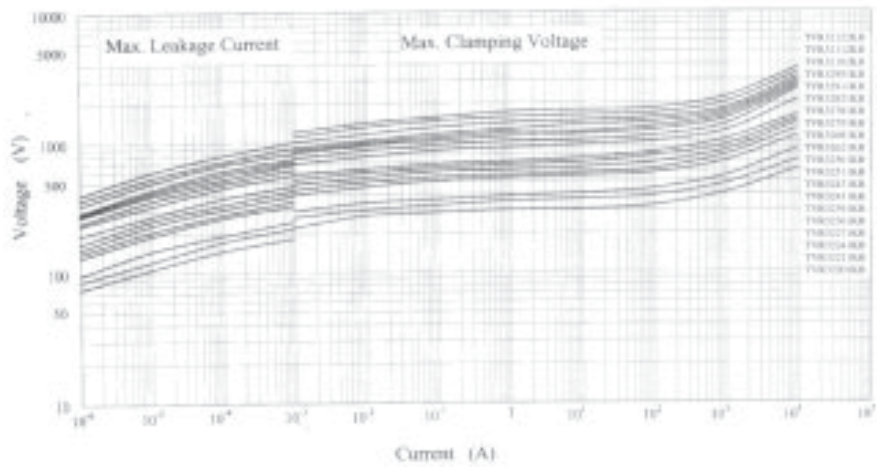



TVR-D SERIES Part Number Code

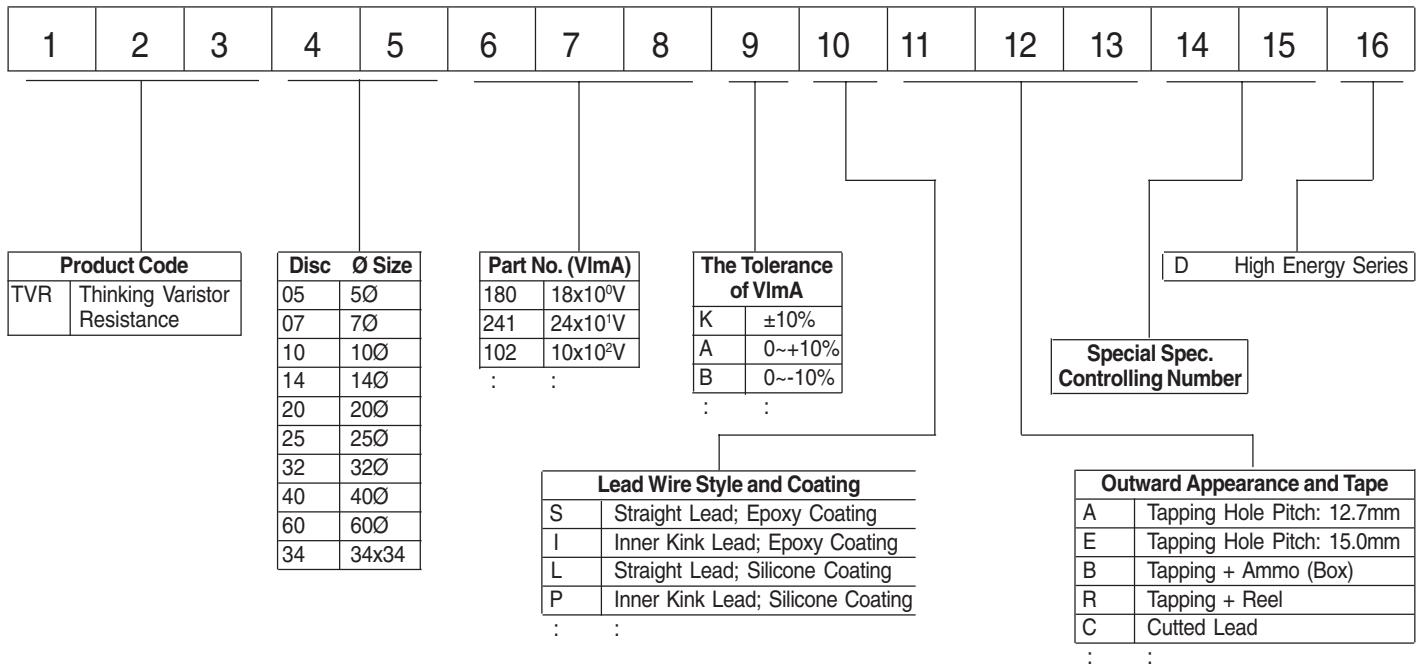



ZINC OXIDE VARISTOR 07Ø SERIES D-SERIES

07Ø D-SERIES

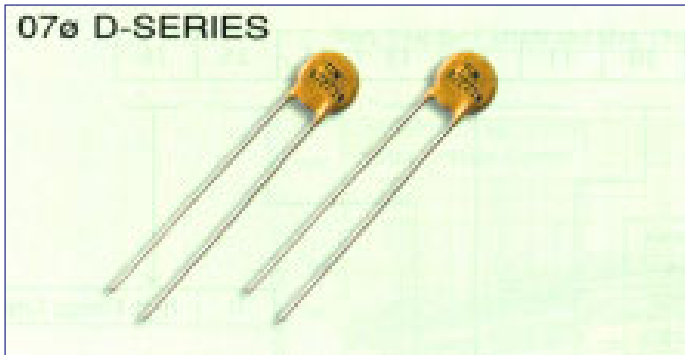

DIMENSION

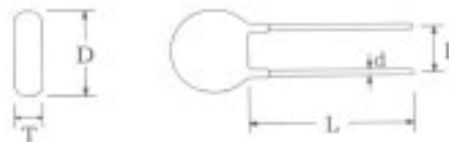

Unit: mm

Disc Ø	Dimensions			
	D max.	L min.	dnor.	Pnor.
07	9.5	30	0.6±0.02	5±1

SPECIFICATION

Part Number	Normal Varistor Voltage @1mA _{DC}	Max. Allowable Voltage		Max. Clamping Voltage @ 10A (8/20µs) (V)	Max. Peak Current (8/20µs)		Rated Power (W)	Max. Energy 10/1000µs (J)	Reference Capacitance @ 1KHZ (pf)
		AC rms (V)	DC (V)		1time (A)	2times (A)			
TVR07201	200	130	170	340	1800	1200	0.25	18	360
TVR07221	220	140	180	360	1800	1200	0.25	20	310
TVR07241	240	150	200	395	1800	1200	0.25	21	290
TVR07271	270	175	225	455	1800	1200	0.25	24	260
TVR07301	300	195	250	500	1800	1200	0.25	28	230
TVR07331	330	215	275	550	1800	1200	0.25	29	210
TVR07361	360	230	300	595	1800	1200	0.25	32	190
TVR07391	390	250	320	650	1800	1200	0.25	35	180
TVR07431	430	275	350	710	1800	1200	0.25	40	160
TVR07471	470	300	385	775	1800	1200	0.25	42	150
TVR07511	510	320	410	845	1800	1200	0.25	46	140
TVR07561	560	350	450	930	1800	1200	0.25	47	130
TVR07621	620	395	510	1020	1800	1200	0.25	51	120
TVR07681	680	420	560	1120	1800	1200	0.25	53	110
TVR07751	750	465	615	1235	1800	1200	0.25	57	100
TVR07821	820	510	670	1355	1800	1200	0.25	61	90

Operating Temperature: -40°C~85°C

Storage Temperature: -40°C~125°C



ZINC OXIDE VARISTOR 100 SERIES D-SERIES

100 D-SERIES

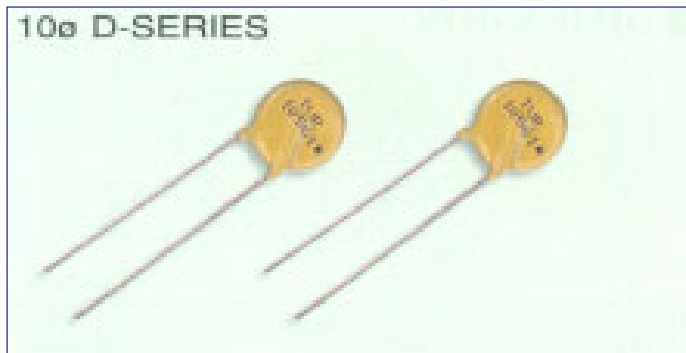

DIMENSION

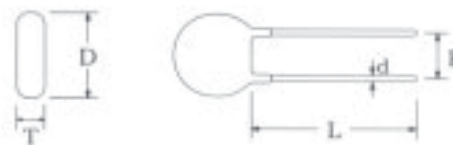

Unit: mm

Disc Ø	Dimensions			
	D max.	L min.	dnor.	Pnor.
10	14.0	30	0.8±0.02	7.5±1

SPECIFICATION

Part Number	Normal Varistor Voltage @1mA _{DC}	Max. Allowable Voltage		Max. Clamping Voltage @25A (8/20µs) (V)	Max. Peak Current (8/20µs)		Rated Power (W)	Max. Energy 10/1000µs (J)	Reference Capacitance @1KHZ (pf)
		AC rms (V)	DC (V)		1time (A)	2times (A)			
TVR10201	200	130	170	340	3500	2500	0.4	45	610
TVR10221	220	140	180	360	3500	2500	0.4	50	550
TVR10241	240	150	200	395	3500	2500	0.4	55	500
TVR10271	270	175	225	455	3500	2500	0.4	58	450
TVR10301	300	195	250	500	3500	2500	0.4	60	400
TVR10331	330	215	275	550	3500	2500	0.4	62	360
TVR10361	360	230	300	595	3500	2500	0.4	65	330
TVR10391	390	250	320	650	3500	2500	0.4	70	300
TVR10431	430	275	350	710	3500	2500	0.4	80	270
TVR10471	470	300	385	775	3500	2500	0.4	85	250
TVR10511	510	320	410	845	3500	2500	0.4	92	230
TVR10561	560	350	450	930	3500	2500	0.4	97	210
TVR10621	620	395	510	1020	3500	2500	0.4	107	190
TVR10681	680	420	560	1120	3500	2500	0.4	110	170
TVR10751	750	465	615	1235	3500	2500	0.4	115	160
TVR10821	820	510	670	1355	3500	2500	0.4	125	150
TVR10911	910	550	745	1500	3500	2500	0.4	130	140
TVR10102	1000	625	825	1650	3500	2500	0.4	145	130
TVR10112	1100	680	895	1815	3500	2500	0.4	155	120

Operating Temperature: -40°C~85°C

Storage Temperature: -40°C~125°C





ZINC OXIDE VARISTOR 1400 SERIES D-SERIES

1400 D-SERIES

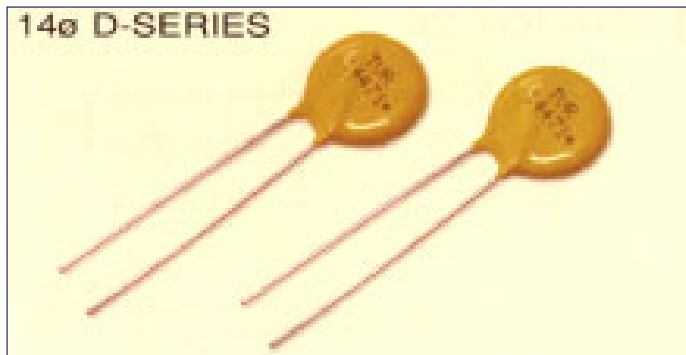

DIMENSION

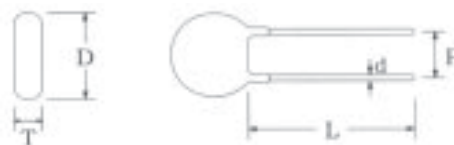

Unit: mm

Disc Ø	Dimensions			
	D max.	L min.	dnor.	Pnor.
14	18.0	30	0.8±0.02	7.5±1

SPECIFICATION

Part Number	Normal Varistor Voltage @1mA _{DC}	Max. Allowable Voltage		Max. Clamping Voltage @50A (8/20µs) (V)	Max. Peak Current (8/20µs)		Rated Power (W)	Max. Energy 10/1000µs (J)	Reference Capacitance @1KHZ (pf)
		AC rms (V)	DC (V)		1time (A)	2times (A)			
TVR14201	200	130	170	340	6500	5000	0.6	70	1000
TVR14221	220	140	180	360	6500	5000	0.6	78	1000
TVR14241	240	150	200	395	6500	5000	0.6	84	900
TVR14271	270	175	225	455	6500	5000	0.6	100	750
TVR14301	300	195	250	500	6000	5000	0.6	110	680
TVR14331	330	215	275	550	6000	5000	0.6	120	620
TVR14361	360	230	300	595	6000	5000	0.6	135	550
TVR14391	390	250	320	650	6000	5000	0.6	145	520
TVR14431	430	275	350	710	6000	5000	0.6	160	500
TVR14471	470	300	385	775	6000	5000	0.6	175	480
TVR14511	510	320	410	845	6000	5000	0.6	190	440
TVR14561	560	350	450	930	6000	5000	0.6	205	400
TVR14621	620	395	510	1020	6000	5000	0.6	215	330
TVR14681	680	420	560	1120	6000	5000	0.6	225	320
TVR14751	750	465	615	1235	6000	5000	0.6	230	310
TVR14821	820	510	670	1355	6000	5000	0.6	240	280
TVR14911	910	550	745	1500	6000	5000	0.6	255	250
TVR14102	1000	625	825	1650	6000	5000	0.6	290	230
TVR14112	1100	680	895	1815	6000	5000	0.6	310	210

Operating Temperature: -40°C~85°C

Storage Temperature: -40°C~125°C



ZINC OXIDE VARISTOR 20Ø D-SERIES

20Ø D-SERIES

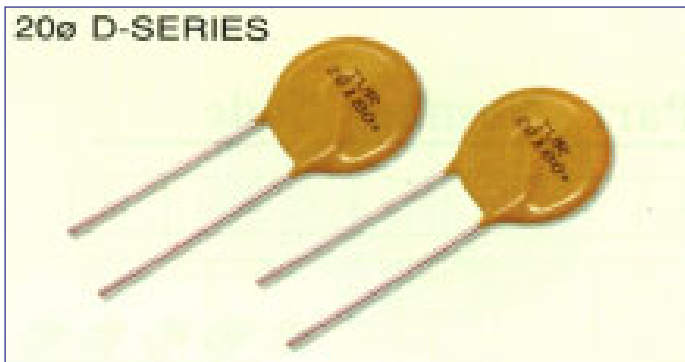

DIMENSION

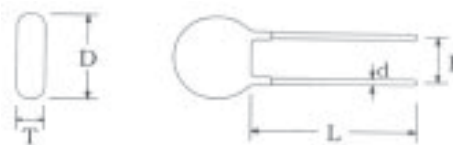

Unit: mm

Disc Ø	Dimensions			
	D max.	L min.	dnor.	Pnor.
20	23.5	26	0.8±0.02	7.5±1

SPECIFICATION

Part Number	Normal Varistor Voltage @1mA _{DC}	Max. Allowable Voltage		Max. Clamping Voltage @100A (8/20µs) (V)	Max. Peak Current (8/20µs)		Rated Power (W)	Max. Energy 10/1000µs (J)	Reference Capacitance @1KHZ (pf)
		AC rms (V)	DC (V)		1time (A)	2times (A)			
TVR20201	200	130	170	340	12000	9000	1.0	150	2000
TVR20221	220	140	180	360	12000	9000	1.0	160	2000
TVR20241	240	150	200	395	12000	9000	1.0	170	1800
TVR20271	270	175	225	455	12000	9000	1.0	190	1600
TVR20301	300	195	250	500	10000	6500	1.0	210	1500
TVR20331	330	215	275	550	10000	6500	1.0	230	1400
TVR20361	360	230	300	595	10000	6500	1.0	270	1200
TVR20391	390	250	320	650	10000	6500	1.0	300	1100
TVR20431	430	275	350	710	10000	6500	1.0	325	1050
TVR20471	470	300	385	775	10000	6500	1.0	350	950
TVR20511	510	320	410	845	10000	6500	1.0	380	900
TVR20561	560	350	450	930	10000	6500	1.0	410	800
TVR20621	620	395	510	1020	10000	6500	1.0	420	700
TVR20681	680	420	560	1120	10000	6500	1.0	430	650
TVR20751	750	465	615	1235	10000	6500	1.0	450	600
TVR20821	820	510	670	1355	10000	6500	1.0	470	530
TVR20911	910	550	745	1500	10000	6500	1.0	510	500
TVR20102	1000	625	825	1650	10000	6500	1.0	556	450
TVR20112	1100	680	895	1815	10000	6500	1.0	620	400

Operating Temperature: -40°C~85°C

Storage Temperature: -40°C~125°C



TVM-SERIES Part Number Code

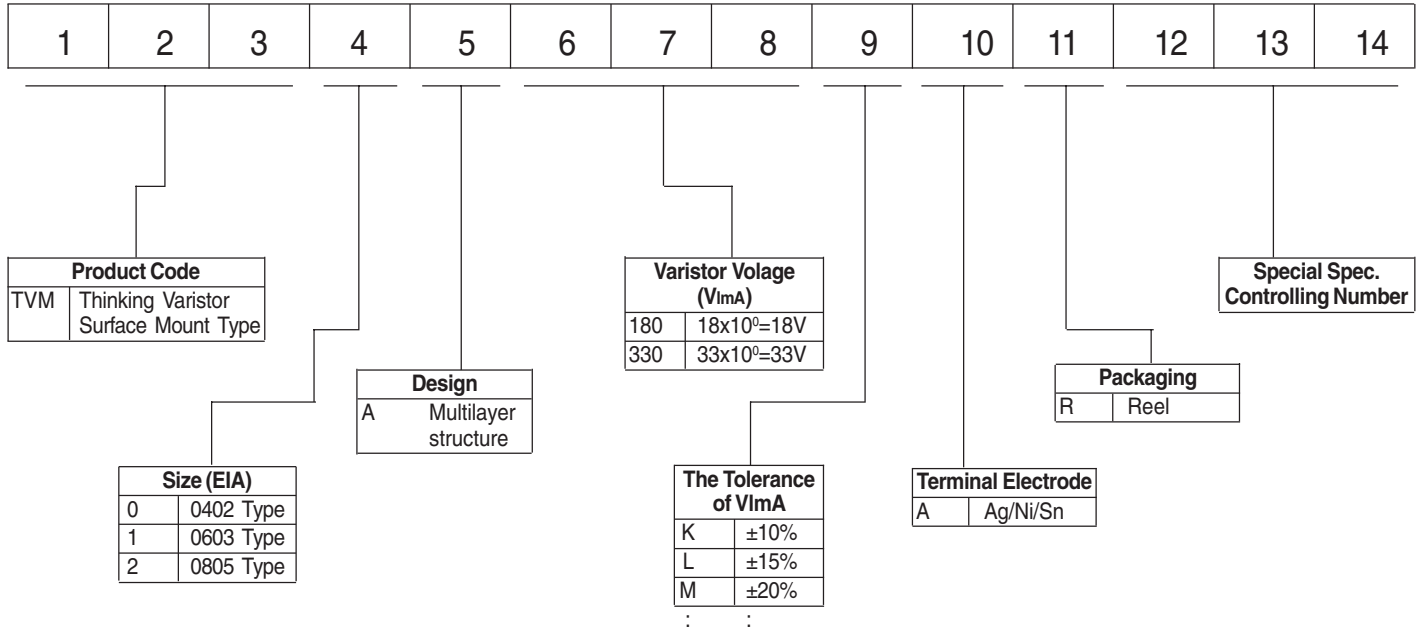



ZINC OXIDE VARISTOR 0402 SERIES

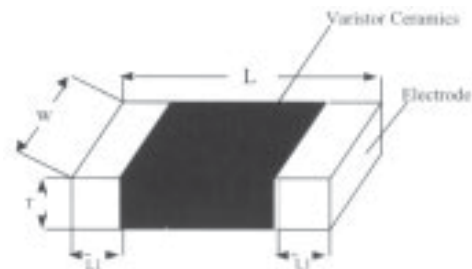

DIMENSION

Unit: mm					
Part No.	Size	L	W	T	L1
TVM0	0402	1.00±0.15	0.50±0.10	0.60max	0.20±0.1

SPECIFICATION

Part No	Varistor Voltage		Max. Allowable Voltage		Max. Clamping Voltage (8/20µs)		Max. Surge Current (8/20µs)	Max. Energy (10/1000µs)	Max. Rate Power	Reference Capacitance @1KHZ
	V _{ImA}	(±%)	V _{AC}	V _{DC}	V _P	I _p	I _{max}	W _{max}	P	C
	(V)		(V)	(V)	(VP)	(A)	(A)	(J)	(W)	(pF)
TVM0A080M	8	20	4	5.5	19	1.0	10	0.05	0.003	230
TVM0A110M	11	20	6	8	27	1.0	10	0.05	0.003	200
TVM0A12RM	12.5	20	7	9	30	1.0	10	0.05	0.003	170
TVM0A150L	15	15	8	11	33	1.0	10	0.05	0.003	130
TVM0A180K	18	10	11	14	35	1.0	10	0.05	0.003	100
TVM0A220K	22	10	14	18	44	1.0	10	0.05	0.003	80
TVM0A270K	27	10	17	22	55	1.0	10	0.05	0.003	65
TVM0A330K	33	10	20	26	63	1.0	10	0.05	0.003	45

Nonlinearity exponent (α)	≥ 20
Leakage Current (IL) at 25°C, V _{dc}	$\leq 20\mu A$

OPERATING TEMPERATURE VS POWER DERATING CURVE

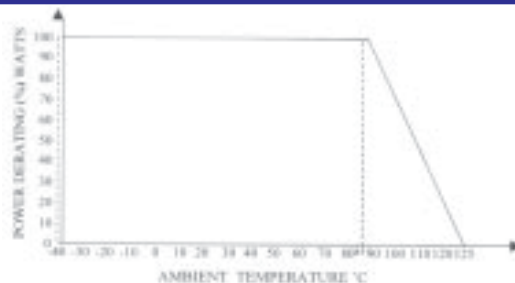



MAX. LEAKAGE CURRENT AND MAX. CLAMPING VOLTAGE CURVES

TVM0A080M~TVM0A330K

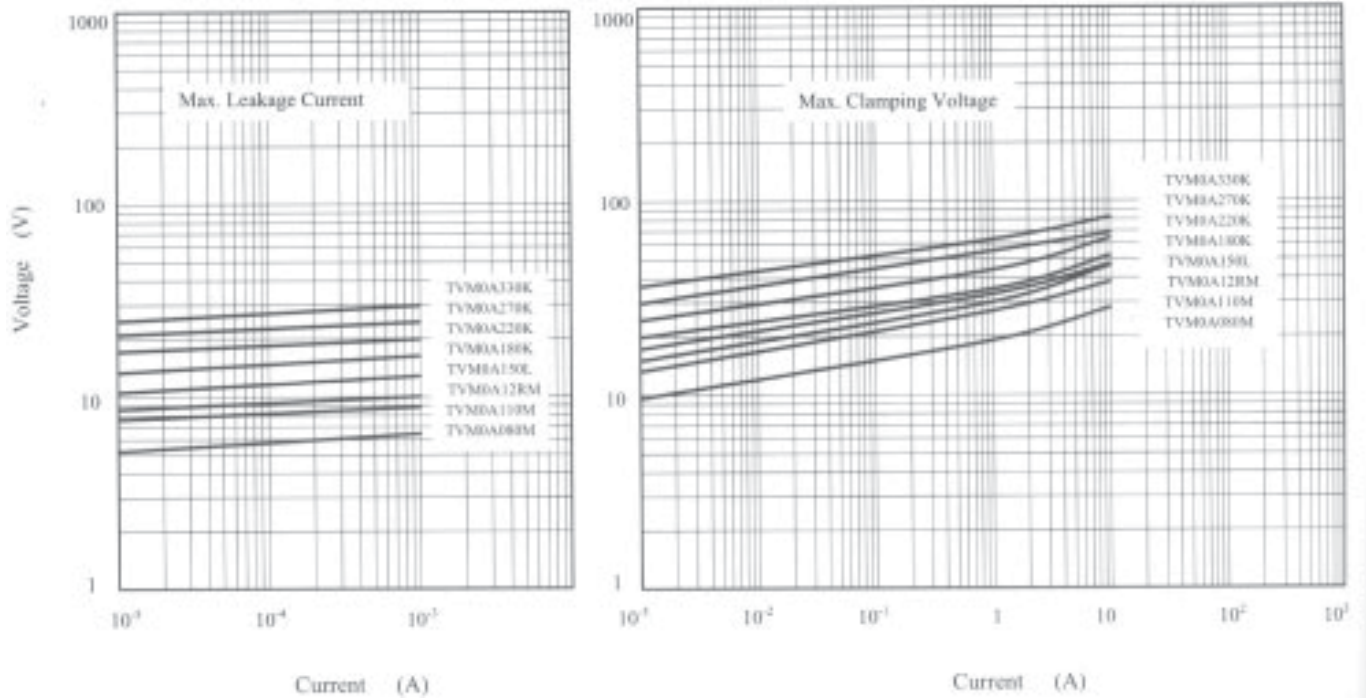

SURGE CURRENT STANDARD WAVEFORM

MAX. SURGE CURRENT DERATING CURVES

EXAMPLE: 8/20 μ S
Tr = 8 μ S
Td = 20 μ S

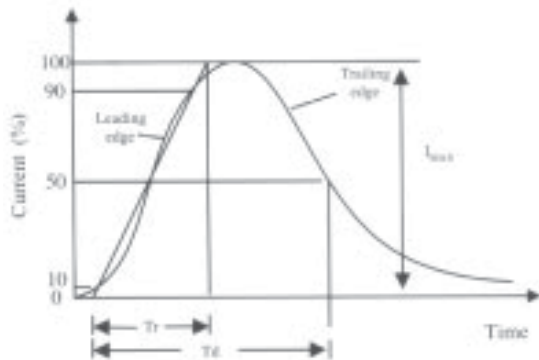

TVM0A080M~TVM0A330K

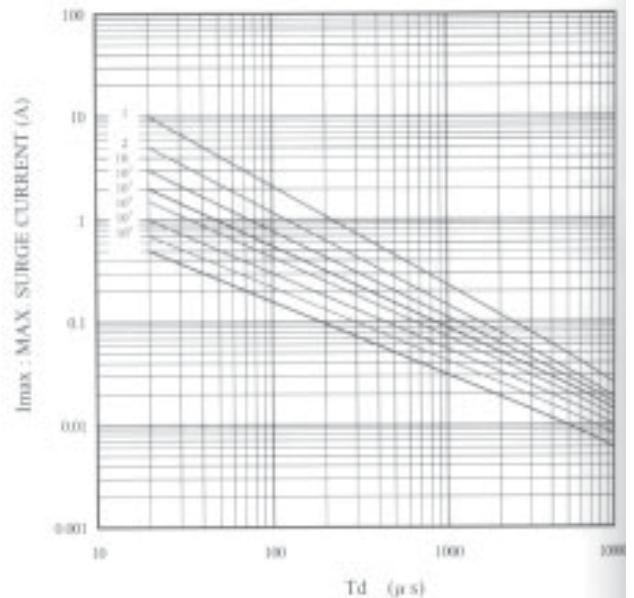



ZINC OXIDE VARISTOR 0603 SERIES

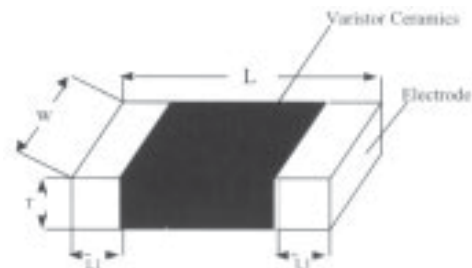

DIMENSION

Unit: mm					
Part No.	Size	L	W	T	L1
TVM1	0603	1.60±0.15	0.80±0.15	0.95max	0.25±0.15

SPECIFICATION

Part No	Varistor Voltage		Max. Allowable Voltage		Max. Clamping Voltage (8/20µs)		Max. Surge Current (8/20µs)	Max. Energy (10/1000µs)	Rate Power	Reference Capacitance @1KHZ
	V _{mA} (V)	(±%)	V _{AC} (V)	V _{DC} (V)	V _P (VP)	I _p (A)	I _{max} (A)	W _{max} (J)	P (W)	C (pF)
TVM1A080M	8	20	4	5.5	19	1.0	30	0.1	0.003	950
TVM1A110M	11	20	6	8	27	1.0	30	0.1	0.003	600
TVM1A12RM	12.5	20	7	9	30	1.0	30	0.1	0.003	570
TVM1A150L	15	15	8	11	33	1.0	30	0.1	0.003	520
TVM1A180K	18	10	11	14	35	1.0	30	0.2	0.003	350
TVM1A220K	22	10	14	18	40	1.0	30	0.2	0.003	300
TVM1A270K	27	10	17	22	46	1.0	30	0.2	0.003	180
TVM1A330K	33	10	20	26	56	1.0	30	0.3	0.003	150
TVM1A390K	39	10	25	31	67	1.0	30	0.3	0.003	100

OPERATING TEMPERATURE VS. POWER DERATING CURVE

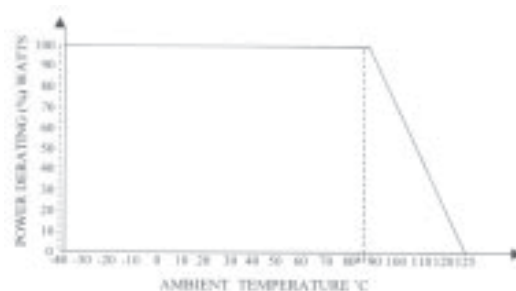

Nonlinearity exponent (α)	≥ 20
Leakage Current (IL) at 25°C, Vdc	$\leq 20\mu\text{A}$



MAX. LEAKAGE CURRENT AND MAX. CLAMPING VOLTAGE CURVES

TVM1A080M-TVM1A390K

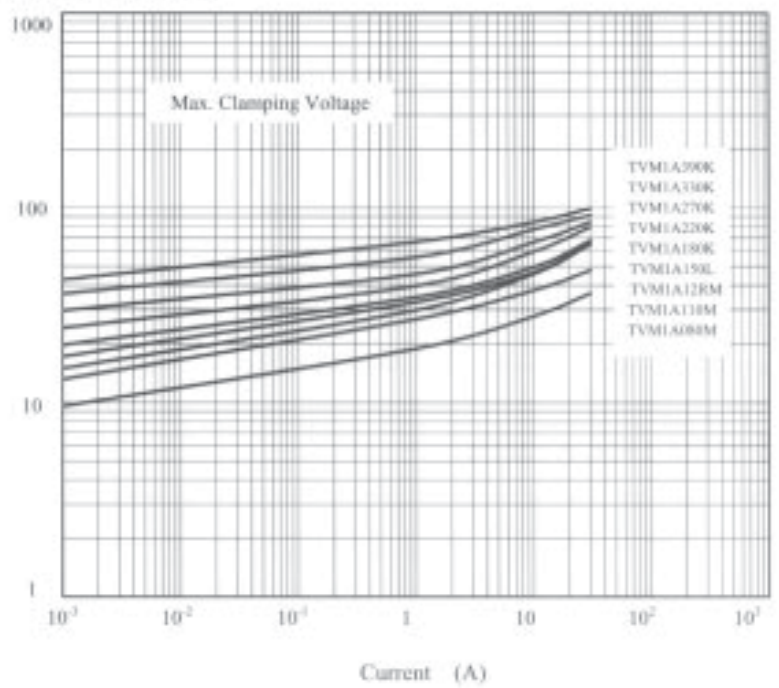
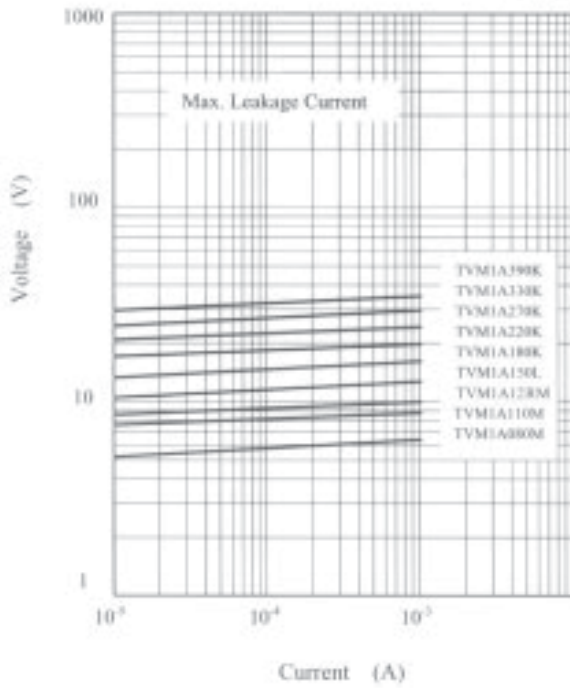

SURGE CURRENT STANDARD WAVEFORM

MAX. SURGE CURRENT DERATING CURVES

EXAMPLE: 8/20 μ S
 Tr = 8 μ S
 Td = 20 μ S

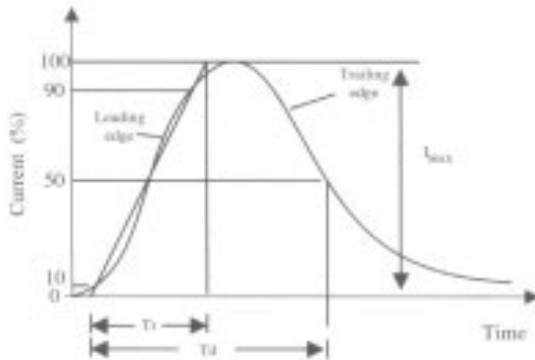

TVM1A080M-TVM1A390K

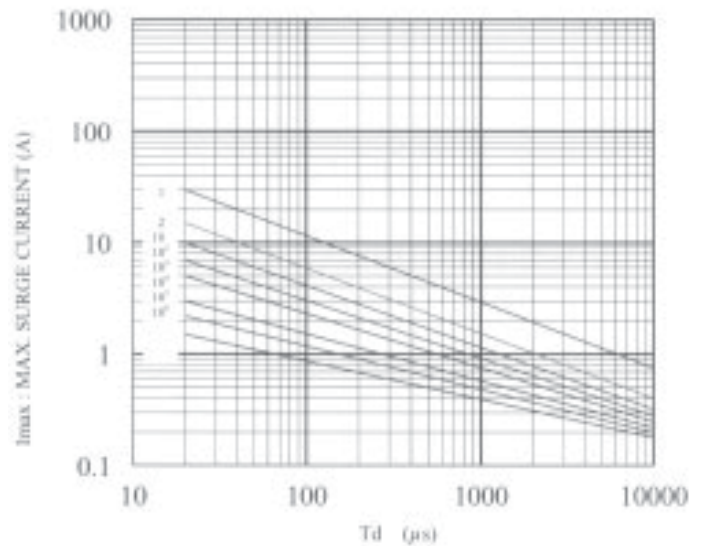



ZINC OXIDE VARISTOR 0805 SERIES

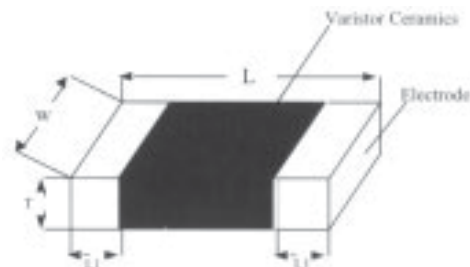

DIMENSION

Unit: mm					
Part No.	Size	L	W	T	L1
TVM2	0805	2.0±0.20	1.25±0.20	1.20max	0.40±0.20

SPECIFICATION

Part No	Varistor Voltage		Max. Allowable Voltage		Max. Clamping Voltage (8/20µs)		Max. Surge Current (8/20µs)	Max. Energy (10/1000µs)	Rate Power	Reference Capacitance @1KHZ
	V _{mA} (V)	(±%)	V _{AC} (V)	V _{DC} (V)	V _P (VP)	I _p (A)	I _{max} (A)	W _{max} (J)	P (W)	C (pF)
TVM2A080M	8	20	4	5.5	19	1.0	60	0.1	0.005	1210
TVM2A110M	11	20	6	8	27	1.0	60	0.2	0.005	1380
TVM2A12RL	12.5	15	7	9	27	1.0	60	0.2	0.005	1050
TVM2A150L	15	15	8	11	33	1.0	60	0.2	0.005	950
TVM2A180K	18	10	11	14	35	1.0	60	0.2	0.005	670
TVM2A220K	22	10	14	18	40	1.0	60	0.3	0.005	540
TVM2A270K	27	10	17	22	46	1.0	60	0.3	0.005	460
TVM2A330K	33	10	20	26	56	1.0	60	0.3	0.005	360
TVM2A390K	39	10	25	31	67	1.0	60	0.3	0.005	180
TVM2A470K	47	10	30	38	77	1.0	60	0.3	0.005	150

OPERATING TEMPERATURE VS. POWER DERATING CURVE

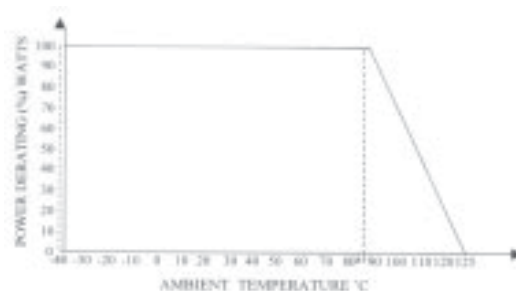

Nonlinearity exponent (α)	≥ 20
Leakage Current (IL) at 25°C, V _{dc}	$\leq 20\mu A$



MAX. LEAKAGE CURRENT AND MAX. CLAMPING VOLTAGE CURVES

TVM2A080M-TVM2A470K

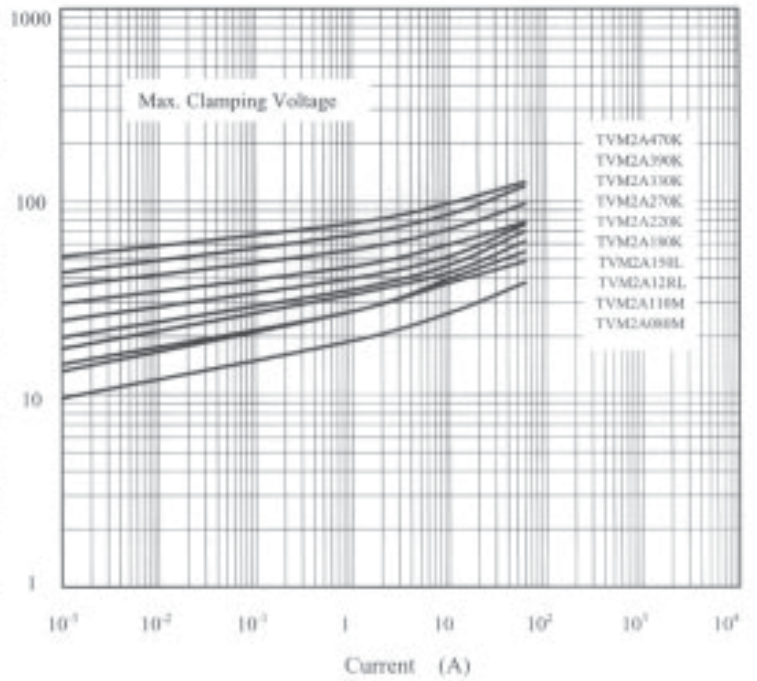
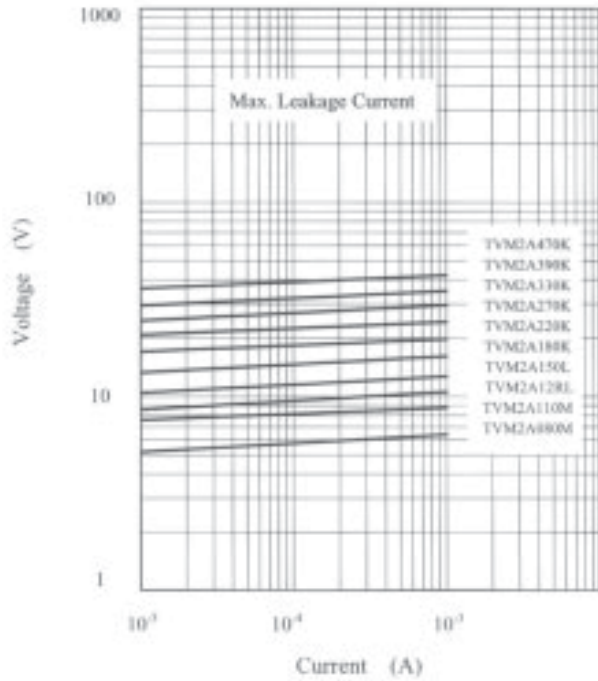

SURGE CURRENT STANDARD WAVEFORM

EXAMPLE: 8/20μS
Tr = 8μS
Td = 20μS

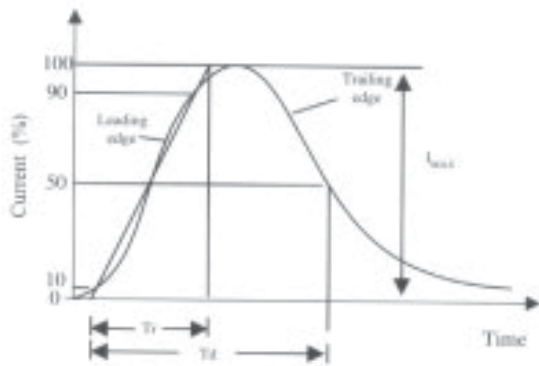

MAX. SURGE CURRENT DERATING CURVES

TVM2A080M-TVM2A470K

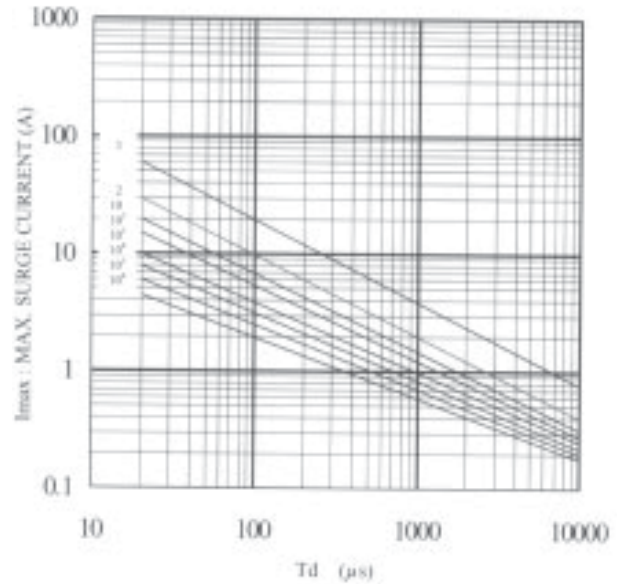



ZINC OXIDE VARISTOR 1206 SERIES

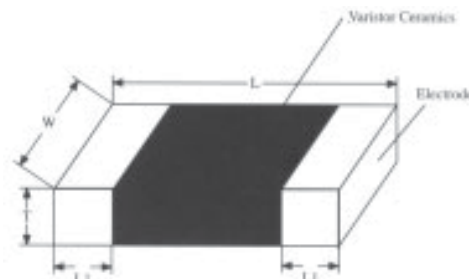

DIMENSION

Unit: mm

Part No.	Size	L	W	T	L1
TVM3	1206	3.2±0.30	1.60±0.20	1.50max	0.50±0.20

SPECIFICATION

Part No	Normal Varistor Voltage	Max. Allowable Voltage		Max. Clamping Voltage (8/20µs)		Max. Surge Current (8/20µs)	Max. Energy (10/1000µs)	Rate Power	Reference Capacitance @1KHZ
	V _{mA} (V)	V _{AC} (V)	V _{DC} (V)	V _P (V)	I _P (A)	I _{max} (A)	W _{max} (J)	P (W)	C (pF)
TVM3A080M	8	4	5.5	17	1.0	150	0.3	0.008	4580
TVM3A110M	11	6	8	25	1.0	200	0.4	0.008	3900
TVM3A150L	15	8	11	30	1.0	200	0.5	0.008	2540
TVM3A180K	18	11	14	33	1.0	200	0.5	0.008	1450
TVM3A220K	22	14	18	38	1.0	200	0.5	0.008	1200
TVM3A270K	27	17	22	44	1.0	200	0.6	0.008	1050
TVM3A330K	33	20	26	54	1.0	200	0.7	0.008	800
TVM3A390K	39	25	31	65	1.0	200	1.0	0.008	650
TVM3A470K	47	30	38	77	1.0	200	1.1	0.008	385
TVM3A560K	56	35	45	90	1.0	100	0.4	0.008	300
TVM3A680K	68	40	56	110	1.0	100	0.5	0.008	250
TVM3A820K	82	50	65	135	1.0	100	0.6	0.008	180
TVM3A101K	100	60	85	165	1.0	100	0.7	0.008	110

OPERATING TEMPERATURE VS. POWER DERATING CURVE

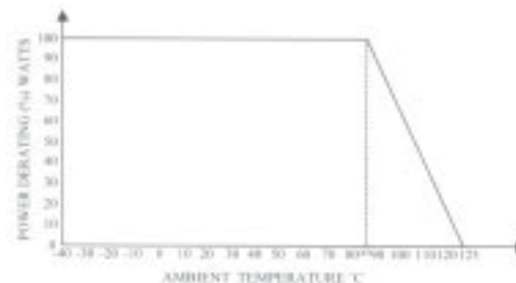

Nonlinearity exponent (α)	≥ 15
Leakage Current (IL) at 25°C, Vdc	$\leq 20\mu A$



MAX. LEAKAGE CURRENT AND MAX. CLAMPING VOLTAGE CURVES

TVM3A080M ~ TVM3A101K

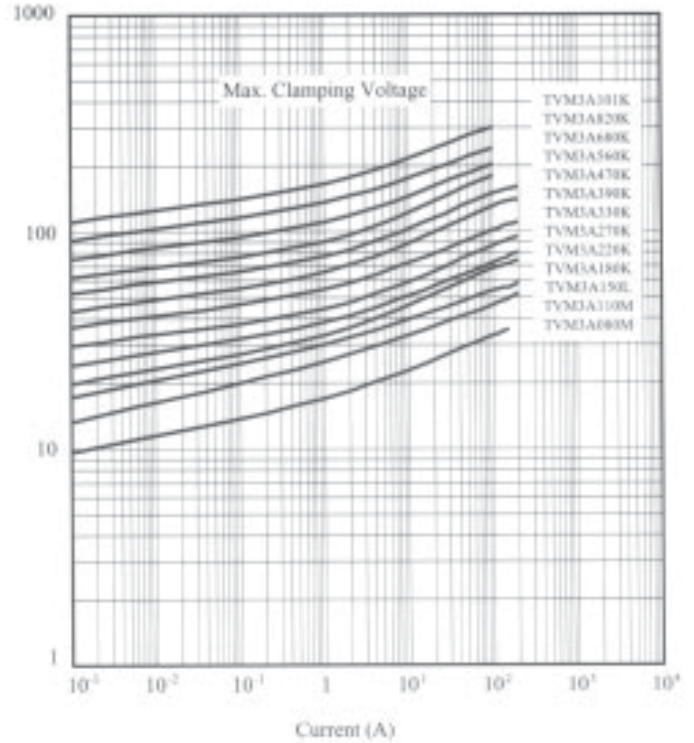
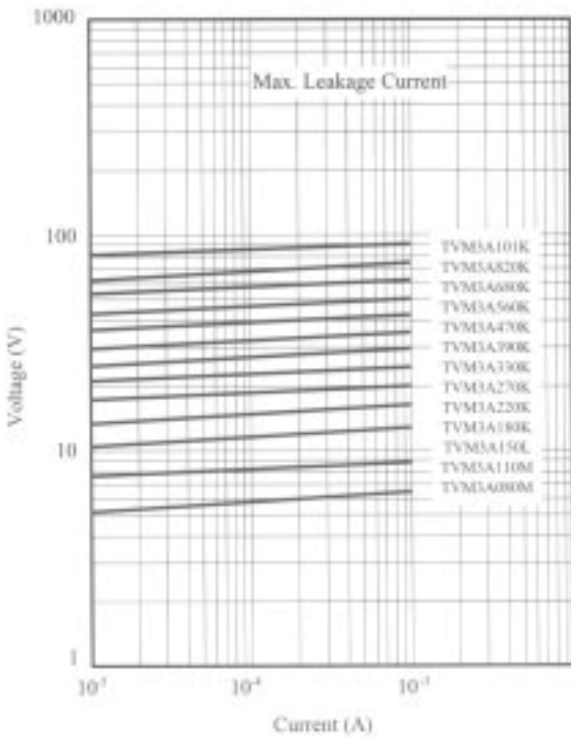

SURGE CURRENT STANDARD WAVEFORM

MAX. SURGE CURRENT DERATING CURVES

EXAMPLE: 8/20 μ S
Tr = 8 μ S
Td = 20 μ S

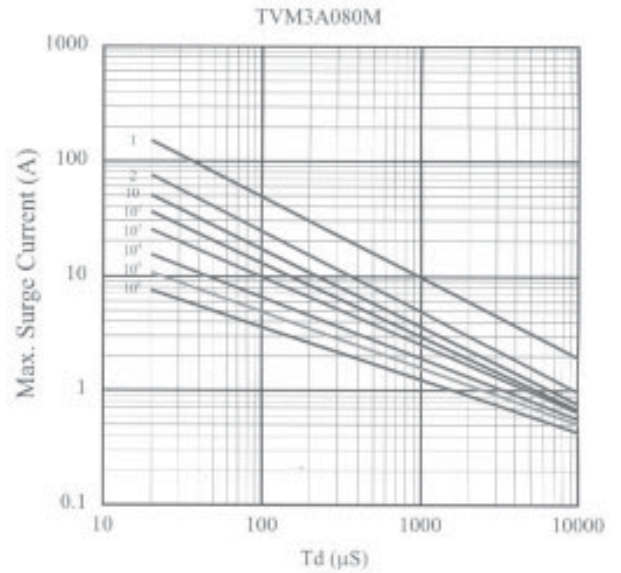



MAX. SURGE CURRENT DERATING CURVES

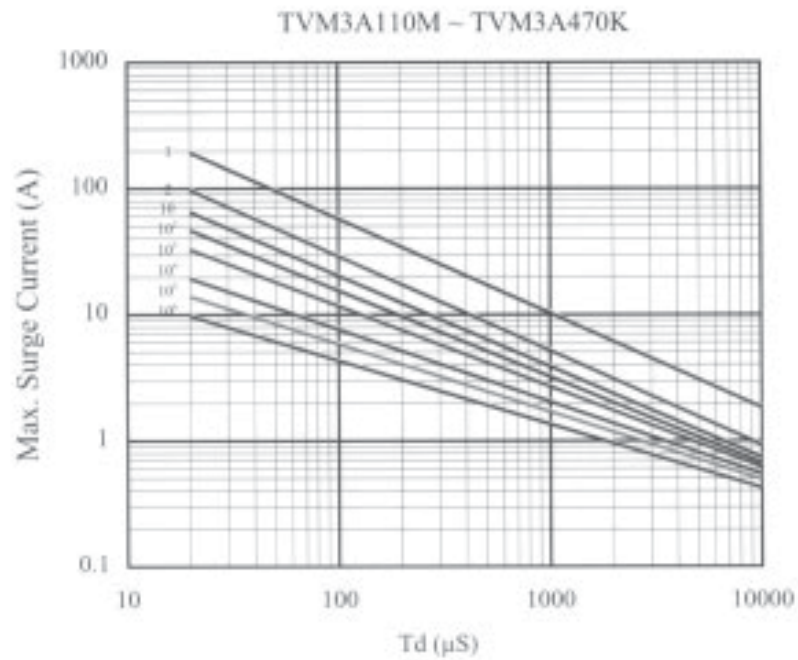

MAX. SURGE CURRENT DERATING CURVES

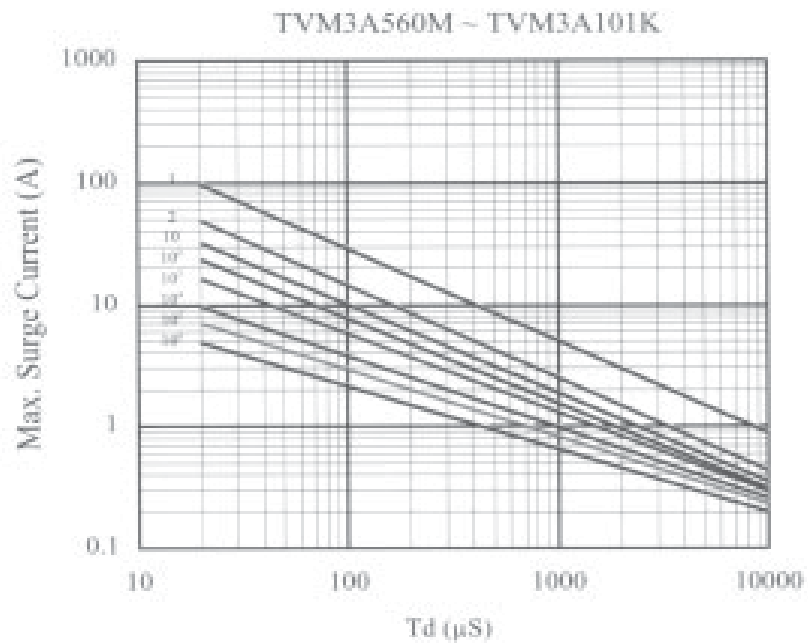



ZINC OXIDE VARISTOR 1210 SERIES

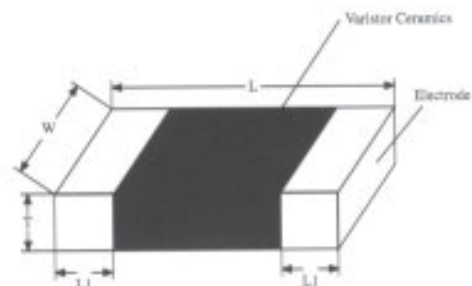

DIMENSION

Unit: mm					
Part No.	Size	L	W	T	L1
TVM4	1210	3.2±0.30	2.50±0.25	1.50max	0.50±0.20

SPECIFICATION

Part No	Normal Varistor Voltage	Max. Allowable Voltage		Max. Clamping Voltage (8/20µs)		Max. Surge Current (8/20µs)	Max. Energy (10/1000µs)	Rate Power	Reference Capacitance @1KHZ
	VImA (V)	VAC (V)	VDC (V)	VP (V)	IP (A)	I _{max} (A)	W _{max} (J)	P (W)	C (pF)
	TVM4A080M	8	4	5.5	17	2.5	250	0.4	0.01
TVM4A110M	11	6	8	25	2.5	300	0.7	0.01	8000
TVM4A150L	15	8	11	30	2.5	400	1.0	0.01	4850
TVM4A180K	18	11	14	33	2.5	400	1.2	0.01	2870
TVM4A220K	22	14	18	38	2.5	400	1.5	0.01	2370
TVM4A270K	27	17	22	44	2.5	400	1.7	0.01	2000
TVM4A330K	33	20	26	54	2.5	400	1.9	0.01	1490
TVM4A390K	39	25	31	65	2.5	300	1.7	0.01	1185
TVM4A470K	47	30	38	77	2.5	300	2.0	0.01	960
TVM4A560K	56	35	45	90	2.5	250	2.0	0.01	600
TVM4A680K	68	40	56	110	2.5	250	2.3	0.01	450
TVM4A820K	82	50	65	135	2.5	200	1.6	0.01	350
TVM4A101K	100	60	85	165	2.5	200	2.0	0.01	230

OPERATING TEMPERATURE VS. POWER DERATING CURVE

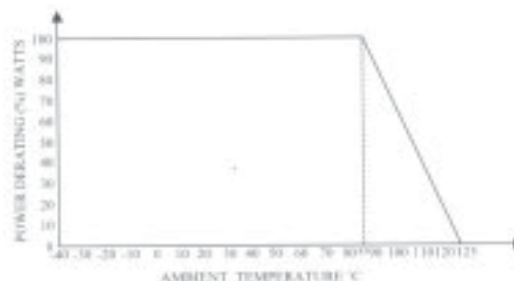

Nonlinearity exponent (α)	≥ 15
Leakage Current (IL) at 25°C, Vdc	$\leq 20\mu\text{A}$



MAX. LEAKAGE CURRENT AND MAX. CLAMPING VOLTAGE CURVES

TVM4A080M – TVM4A101K

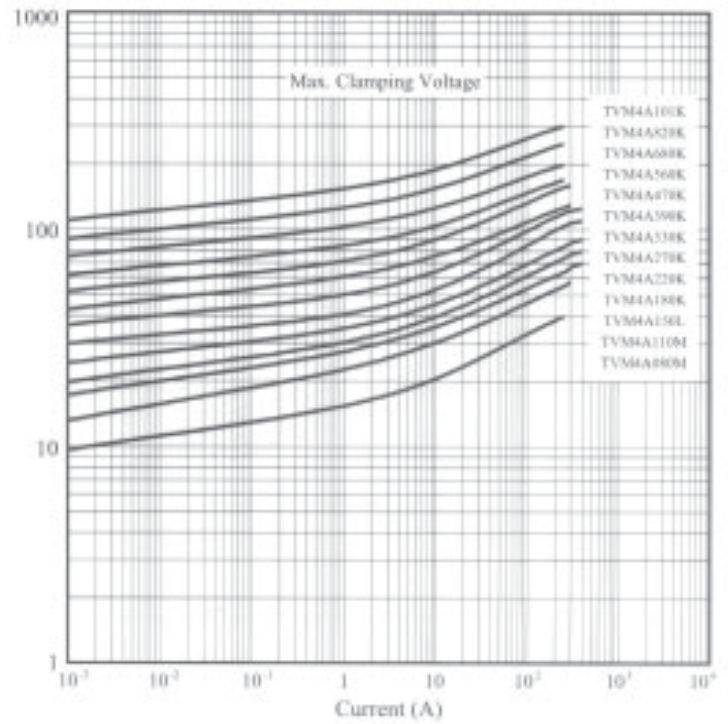
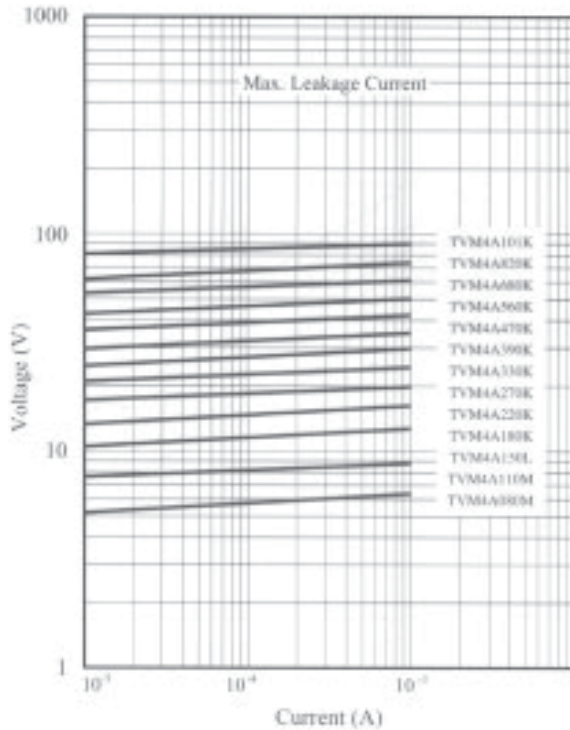

SURGE CURRENT STANDARD WAVEFORM

MAX. SURGE CURRENT DERATING CURVES

EXAMPLE: $8/20\mu\text{s}$
 $T_r = 8\mu\text{s}$
 $T_d = 20\mu\text{s}$



TVM4A080M
 TVM4A560K – TVM4A680K

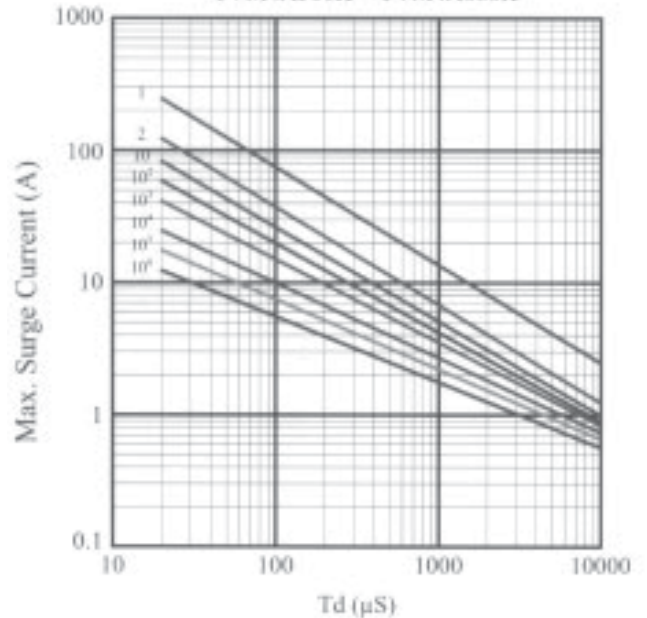



MAX SURGE CURRENT DERATING CURVES

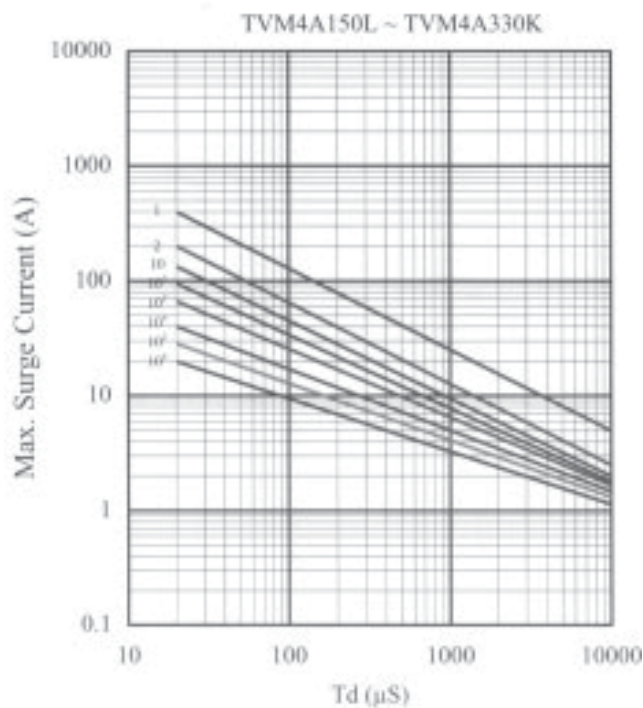

MAX SURGE CURRENT DERATING CURVES

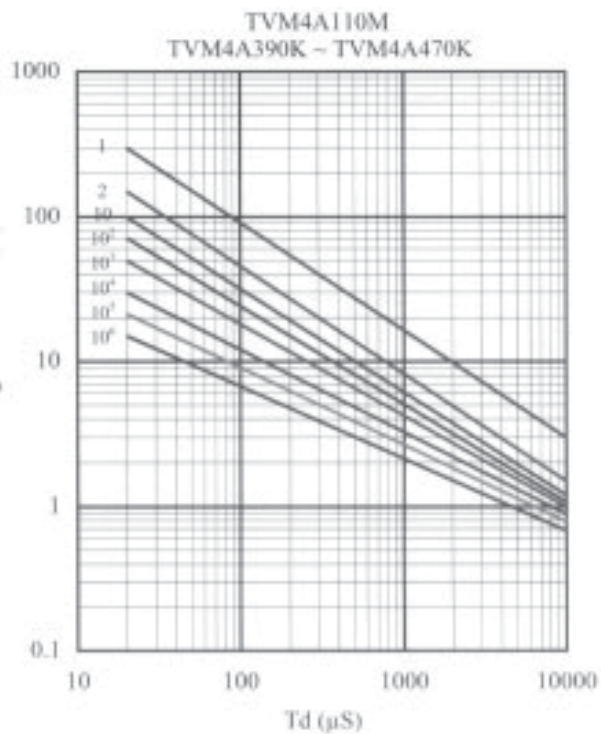

MAX SURGE CURRENT DERATING CURVES

