

High side current sense amplifier

Features

- Independent supply and input common-mode voltages
- Wide common-mode operating range: 2.8 to 30V
- Wide common-mode surviving range: -0.3 to 60V (load-dump)
- Wide supply voltage range: 4 to 24V
- Low current consumption: I_{CC} max = 300 μ A
- Internally fixed gain: 20V/V, 50V/V or 100V/V
- Buffered output

Applications

- Automotive current monitoring
- Notebook computers
- DC motor control
- Photovoltaic systems
- Battery chargers
- Precision current sources

Description

The TSC101 measures a small differential voltage on a high-side shunt resistor and translates it into a ground-referenced output voltage. The gain is internally fixed.

Wide input common-mode voltage range, low quiescent current, and tiny SOT23 packaging enable use in a wide variety of applications.

Input common-mode and power supply voltages are independent. Common-mode voltage can range from 2.8V to 30V in operating conditions and up to 60V in absolute maximum ratings.

Current consumption lower than 300 μ A and wide supply voltage range allow to connect the power supply to either side of the current measurement shunt with minimal error.

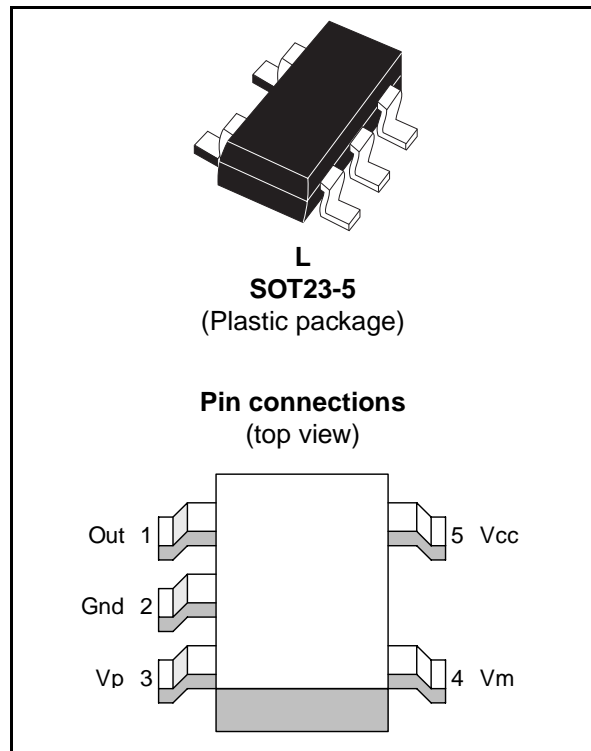

1 Application schematics and pin description

The TSC101 high-side current-sense amplifier features a 2.8V to 30V input common-mode range that is independent of supply voltage. The main advantage of this feature is to allow high-side current sensing at voltages much greater than the supply voltage (V_{CC}).

Figure 1. Application schematics

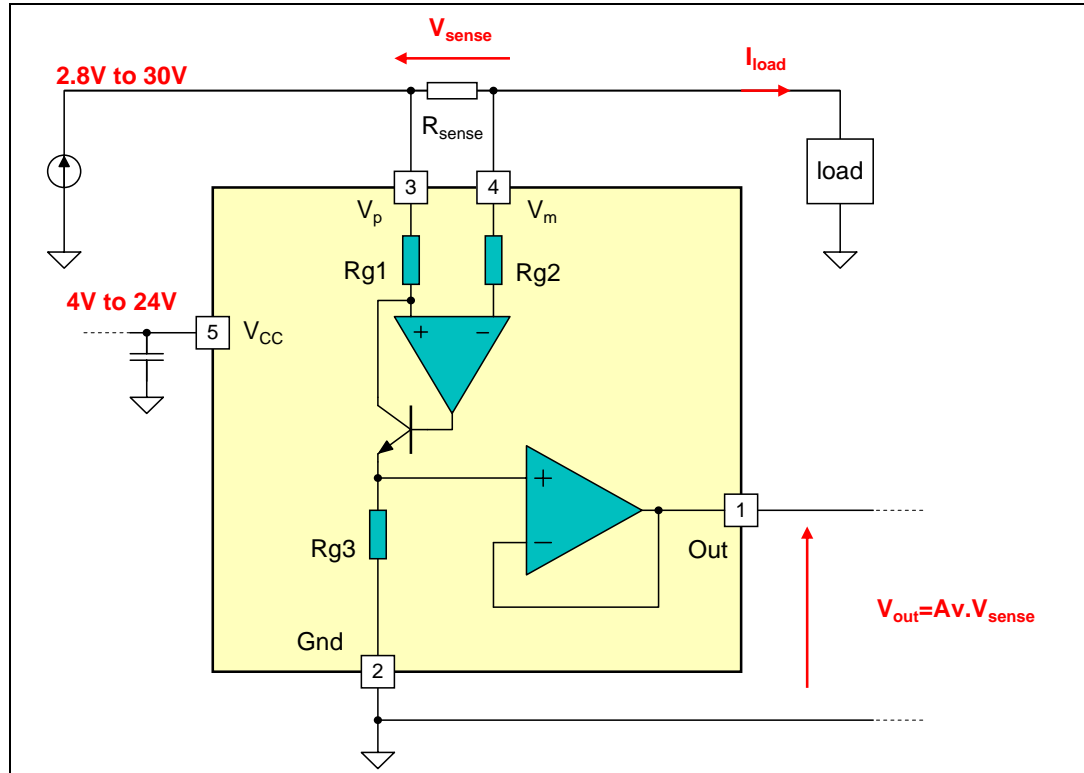

Table 1 describes the function of each pin. The pin positions are shown in the illustration on the cover page and in Figure 1 above.

Table 1. Pin descriptions

Symbol	Type	Function
Out	Analog output	The output voltage, proportional to the magnitude of the sense voltage $V_p - V_m$.
Gnd	Power supply	Ground line.
V_{CC}	Power supply	Positive power supply line.
V_p	Analog input	Connection for the external sense resistor. The measured current enters the shunt on the V_p side.
V_m	Analog input	Connection for the external sense resistor. The measured current exits the shunt on the V_m side.

2 Absolute maximum ratings and operating conditions

Table 2. Absolute maximum ratings

Symbol	Parameter	Value	Unit
V_{id}	Input pins differential voltage ($V_p - V_m$)	± 60	V
V_i	Input pin voltages (V_p and V_m) ⁽¹⁾	-0.3 to 60	V
V_{CC}	DC supply voltage ⁽¹⁾	-0.3 to 25	V
V_{out}	DC output pin voltage ⁽¹⁾	-0.3 to V_{CC}	V
T_{stg}	Storage temperature	-55 to 150	°C
T_j	Maximum junction temperature	150	°C
R_{thja}	SOT23-5 thermal resistance junction to ambient	250	°C/W
ESD	HBM: human body model ⁽²⁾	2.5	kV
	MM: machine model ⁽³⁾	150	V

1. Voltage values are measured with respect to the ground pin.
2. Human body model: A 100pF capacitor is charged to the specified voltage, then discharged through a 1.5k Ω resistor between two pins of the device. This is done for all couples of connected pin combinations while the other pins are floating.
3. Machine model: A 200pF capacitor is charged to the specified voltage, then discharged directly between two pins of the device with no external series resistor (internal resistor < 5 Ω). This is done for all couples of connected pin combinations while the other pins are floating.

Table 3. Operating conditions

Symbol	Parameter	Value	Unit
V_{CC}	DC supply voltage from T_{min} to T_{max}	4.0 to 24	V
T_{oper}	Operational temperature range (T_{min} to T_{max})	-40 to 125	°C
V_{icm}	Common mode voltage range	2.8 to 30	V

3 Electrical characteristics

Table 4. Supply⁽¹⁾

Symbol	Parameter	Test conditions	Min.	Typ.	Max.	Unit
I_{CC}	Total supply current	$V_{sense}=0V$ $T_{min} < T_{amb} < T_{max}$		165	300	μA

1. Unless otherwise specified, the test conditions are $T_{amb}=25^{\circ}C$, $V_{CC}=12V$, $V_{sense}=V_p-V_m=50mV$, $V_m=12V$, no load on Out.

Table 5. Input⁽¹⁾

Symbol	Parameter	Test conditions	Min.	Typ.	Max.	Unit
CMR	Common mode rejection Variation of V_{out} versus V_{icm} referred to input ⁽²⁾	$2.8V < V_{icm} < 30V$ $T_{min} < T_{amb} < T_{max}$	90	105		dB
SVR	Supply voltage rejection Variation of V_{out} versus V_{CC} ⁽³⁾	$4.0V < V_{CC} < 24V$ $V_{sense}=30mV$ $T_{min} < T_{amb} < T_{max}$	90	105		dB
V_{os}	Input offset voltage ⁽⁴⁾	$T_{amb} = 25^{\circ}C$ $T_{min} < T_{amb} < T_{max}$		± 0.2 ± 0.9	± 1.5 ± 2.3	mV
dV_{os}/dT	Input offset drift vs. T	$T_{min} < T_{amb} < T_{max}$		-3		$\mu V/^{\circ}C$
I_{lk}	Input leakage current	$V_{CC} = 0V$ $T_{min} < T_{amb} < T_{max}$			1	μA
I_{ib}	Input bias current	$V_{sense} = 0V$ $T_{min} < T_{amb} < T_{max}$		5.5	8	μA

1. Unless otherwise specified, the test conditions are $T_{amb}=25^{\circ}C$, $V_{CC}=12V$, $V_{sense}=V_p-V_m=50mV$, $V_m=12V$, no load on Out.

2. See [Common mode rejection ratio \(CMR\) on page 11](#) for the definition of CMR.

3. See [Supply voltage rejection ratio \(SVR\) on page 11](#) for the definition of SVR.

4. See [Gain \(Av\) and input offset voltage \(\$V_{os}\$ \) on page 11](#) for the definition of V_{os} .

Table 6. Output⁽¹⁾

Symbol	Parameter	Test conditions	Min.	Typ.	Max.	Unit
A_v	Gain	TSC101A TSC101B TSC101C		20 50 100		V/V
ΔA_v	Gain accuracy	$T_{amb}=25^{\circ}\text{C}$ $T_{min} < T_{amb} < T_{max}$			± 2.5 ± 4.5	%
$\Delta V_{out}/\Delta T$	Output voltage drift vs. T ⁽²⁾	$T_{min} < T_{amb} < T_{max}$		0.4		mV/°C
$\Delta V_{out}/\Delta I_{out}$	Output stage load regulation	$-10\text{mA} < I_{out} < 10\text{mA}$ I_{out} sink or source current		3	4	mV/mA
ΔV_{out}	Total output voltage accuracy ⁽³⁾	$V_{sense}=50\text{mV}$ $T_{amb}=25^{\circ}\text{C}$ $T_{min} < T_{amb} < T_{max}$			± 2.5 ± 4.5	%
ΔV_{out}	Total output voltage accuracy	$V_{sense}=100\text{mV}$ $T_{amb}=25^{\circ}\text{C}$ $T_{min} < T_{amb} < T_{max}$			± 3.5 ± 5	%
ΔV_{out}	Total output voltage accuracy	$V_{sense}=20\text{mV}$ $T_{amb}=25^{\circ}\text{C}$ $T_{min} < T_{amb} < T_{max}$			± 8 ± 11	%
ΔV_{out}	Total output voltage accuracy	$V_{sense}=10\text{mV}$ $T_{amb}=25^{\circ}\text{C}$ $T_{min} < T_{amb} < T_{max}$			± 15 ± 20	%
$I_{sc-sink}$	Short-circuit sink current	Out connected to V_{CC} , $V_{sense}=-1\text{V}$	30	60		mA
$I_{sc-source}$	Short-circuit source current	Out connected to Gnd $V_{sense}=1\text{V}$	15	26		mA
V_{oh}	Output stage high-state saturation voltage $V_{oh}=V_{CC}-V_{out}$	$V_{sense}=1\text{V}$ $I_{out}=1\text{mA}$		0.8	1	V
V_{ol}	Output stage low-state saturation voltage	$V_{sense}=-1\text{V}$ $I_{out}=1\text{mA}$		50	100	mV

1. Unless otherwise specified, the test conditions are $T_{amb}=25^{\circ}\text{C}$, $V_{CC}=12\text{V}$, $V_{sense}=V_p-V_m=50\text{mV}$, $V_m=12\text{V}$, no load on Out.
2. See [Output voltage drift versus temperature on page 12](#) for the definition.
3. Output voltage accuracy is the difference with the expected theoretical output voltage $V_{out-th}=A_v \cdot V_{sense}$. See [Output voltage accuracy on page 13](#) for a more detailed definition.

Table 7. Frequency response⁽¹⁾

Symbol	Parameter	Test conditions	Min.	Typ.	Max.	Unit
ts	Output settling to 1% final value	V _{sense} =10mV to 100mV, C _{load} =47pF TSC101A TSC101B TSC101C		3 6 10		μs
SR	Slew rate	V _{sense} =10mV to 100mV	0.55	0.9		V/μs
BW	3dB bandwidth	C _{load} =47pF, V _{sense} =100mV TSC101A TSC101B TSC101C		500 670 450		kHz

1. Unless otherwise specified, the test conditions are T_{amb}=25°C, V_{CC}=12V, V_{sense}=V_p-V_m=50mV, V_m=12V, no load on Out.

Table 8. Noise⁽¹⁾

Symbol	Parameter	Test conditions	Min.	Typ.	Max.	Unit
	Total output voltage noise			50		nV/√Hz

1. Unless otherwise specified, the test conditions are T_{amb}=25°C, V_{CC}=12V, V_{sense}=V_p-V_m=50mV, V_m=12V, no load on Out.

Electrical characteristics curves

In all of the electrical characteristics curves that follow, the tested device is a TSC101C, and the test conditions are T_{amb}=25°C, V_{CC}=12V, V_{sense}=V_p-V_m=50mV, V_m=12V, no load on Out unless otherwise specified.

Figure 2. Supply current vs. supply voltage
($V_{sense} = 0V$)

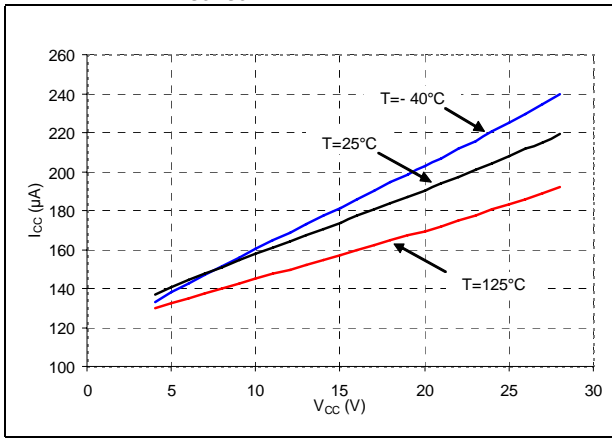

Figure 3. Supply current vs. V_{sense}

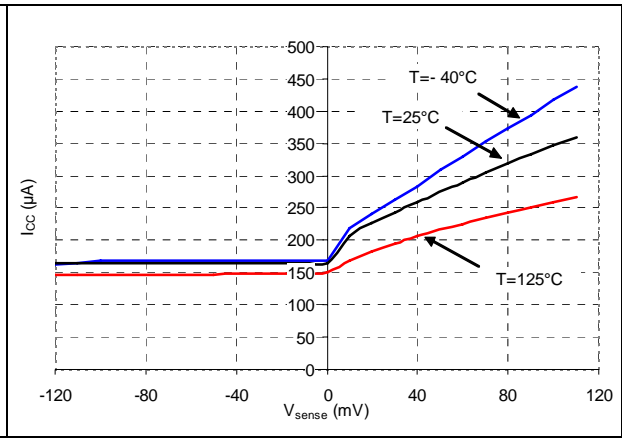

Figure 4. V_p pin input bias current vs. V_{sense}

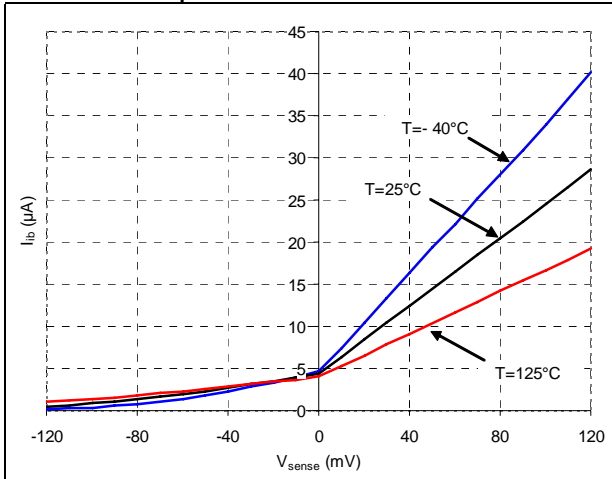

Figure 5. V_m pin input bias current vs. V_{sense}

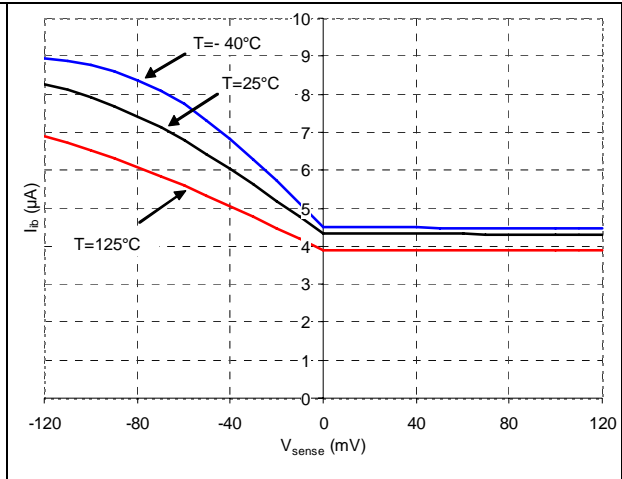

Figure 6. Minimum common mode operating voltage vs. temperature

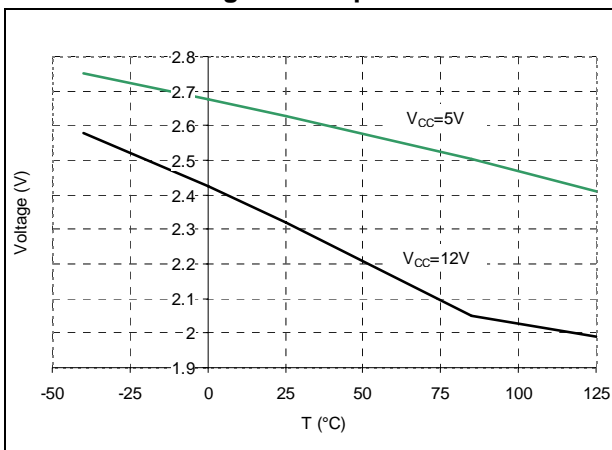

Figure 7. Output stage low-state saturation voltage versus output current ($V_{sense} = -1V$)

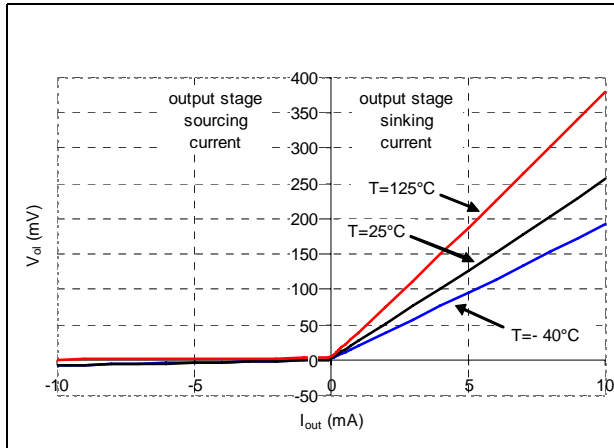

Figure 8. Output stage high-state saturation voltage versus output current ($V_{sense} = +1V$)

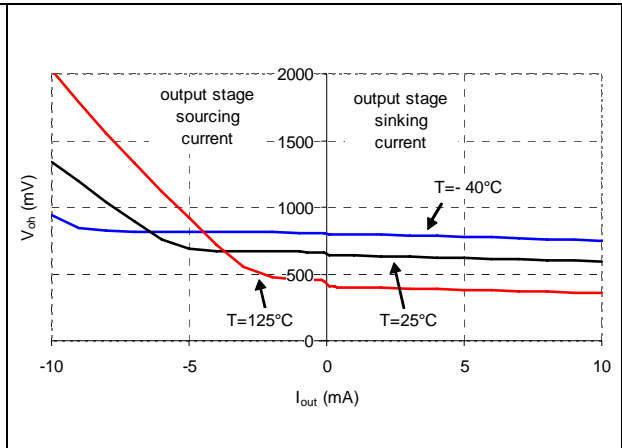

Figure 9. Output short-circuit source current versus temperature (Out pin connected to ground)

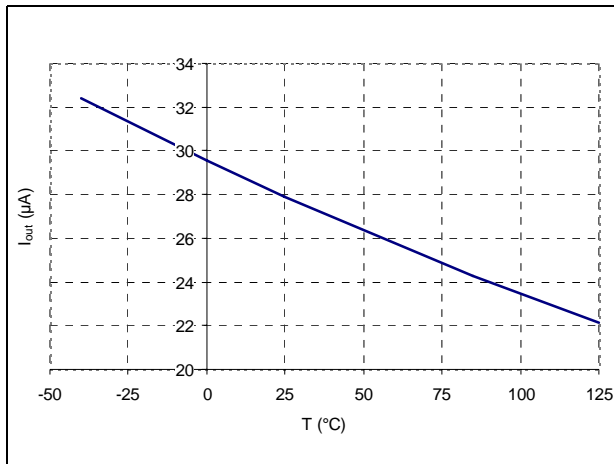

Figure 10. Output short-circuit sink current versus temperature (Out pin connected to VCC)

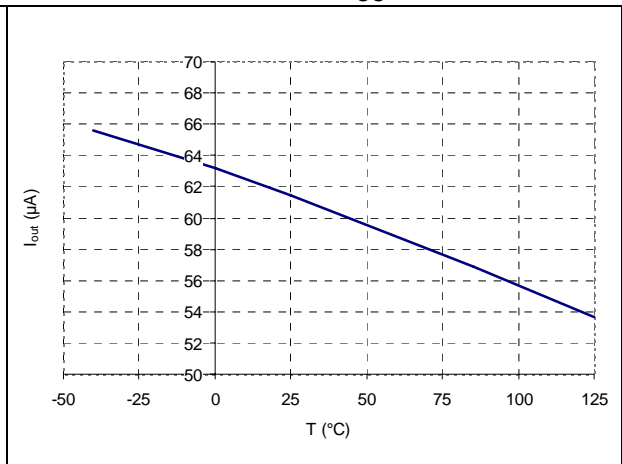

Figure 11. Output stage load regulation

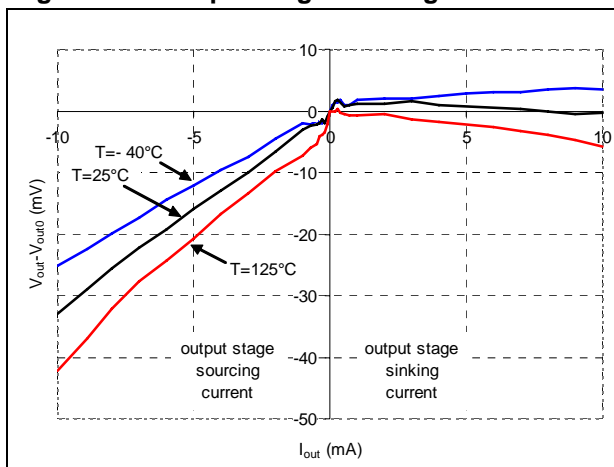

Figure 12. Input offset drift versus temperature

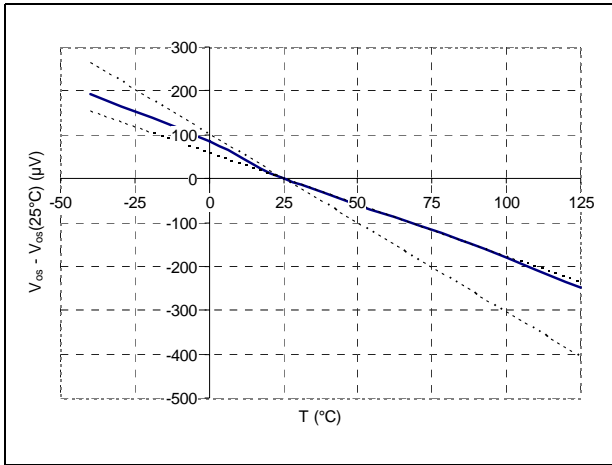

Figure 13. Output voltage drift versus temperature

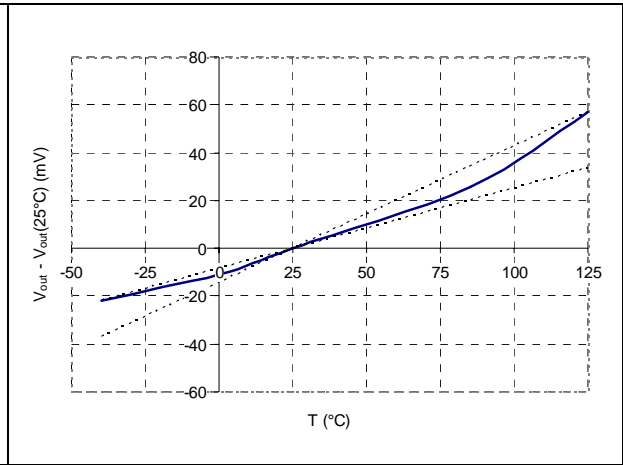

Figure 14. Bode diagram ($V_{sense}=100\text{mV}$)

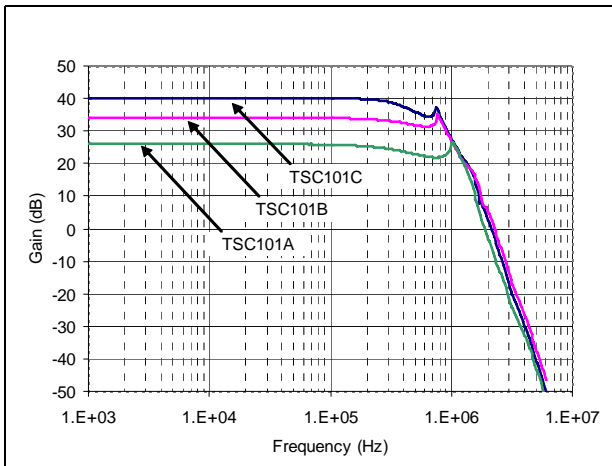

Figure 15. Power-supply rejection ratio versus frequency

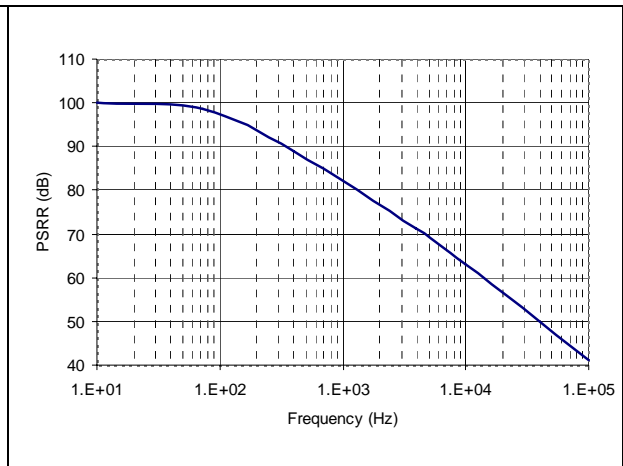

Figure 16. Total output voltage accuracy versus V_{sense}

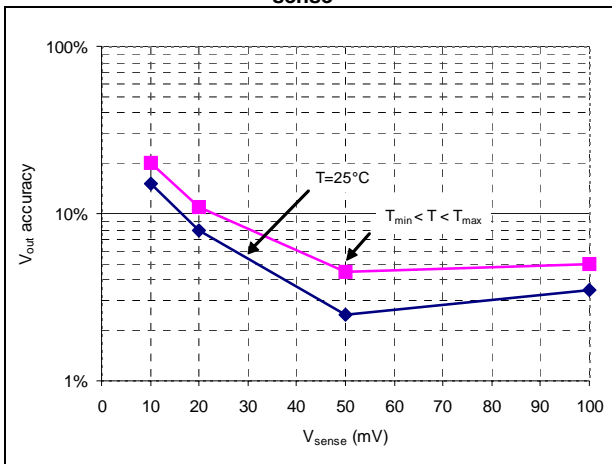

Figure 17. Output voltage versus V_{sense}

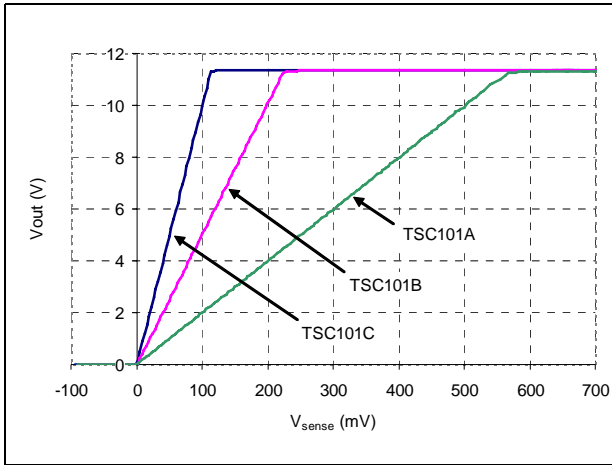

Figure 18. Output voltage versus V_{sense} (detail for low V_{sense} values)

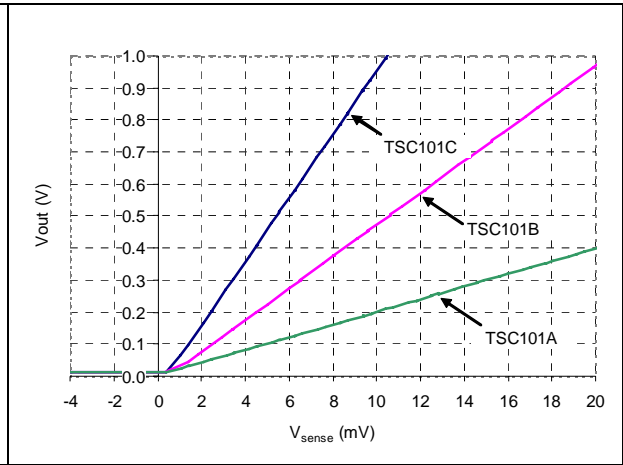
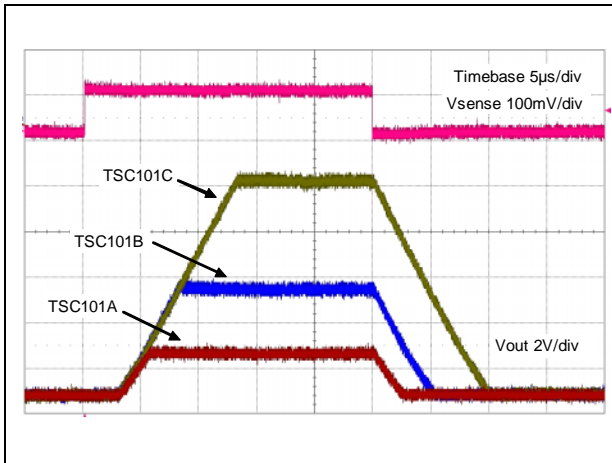

Figure 19. Step response



4 Parameter definitions

Common mode rejection ratio (CMR)

The common-mode rejection ratio (CMR) measures the ability of the current-sensing amplifier to reject any DC voltage applied on both inputs V_p and V_m . The CMR is referred back to the input so that its effect can be compared with the applied differential signal. The CMR is defined by the formula:

$$\text{CMR} = -20 \cdot \log \frac{\Delta V_{\text{out}}}{\Delta V_{\text{icm}} \cdot A_v}$$

Supply voltage rejection ratio (SVR)

The supply-voltage rejection ratio (SVR) measures the ability of the current-sensing amplifier to reject any variation of the supply voltage V_{CC} . The SVR is referred back to the input so that its effect can be compared with the applied differential signal. The SVR is defined by the formula:

$$\text{SVR} = -20 \cdot \log \frac{\Delta V_{\text{out}}}{\Delta V_{CC} \cdot A_v}$$

Gain (A_v) and input offset voltage (V_{os})

The input offset voltage is defined as the intersection between the linear regression of the V_{out} versus V_{sense} curve with the X-axis (see [Figure 20](#)). If V_{out1} is the output voltage with $V_{\text{sense}}=V_{\text{sense1}}=50\text{mV}$ and V_{out2} is the output voltage with $V_{\text{sense}}=V_{\text{sense2}}=5\text{mV}$, then V_{os} can be calculated with the following formula:

$$V_{os} = V_{\text{sense1}} - \left(\frac{V_{\text{sense1}} - V_{\text{sense2}}}{V_{\text{out1}} - V_{\text{out2}}} \cdot V_{\text{out1}} \right)$$

The amplification gain A_v is defined as the ratio between output voltage and input differential voltage:

$$A_v = \frac{V_{\text{out}}}{V_{\text{sense}}}$$

Figure 20. V_{out} versus V_{sense} characteristics: detail for low V_{sense} values

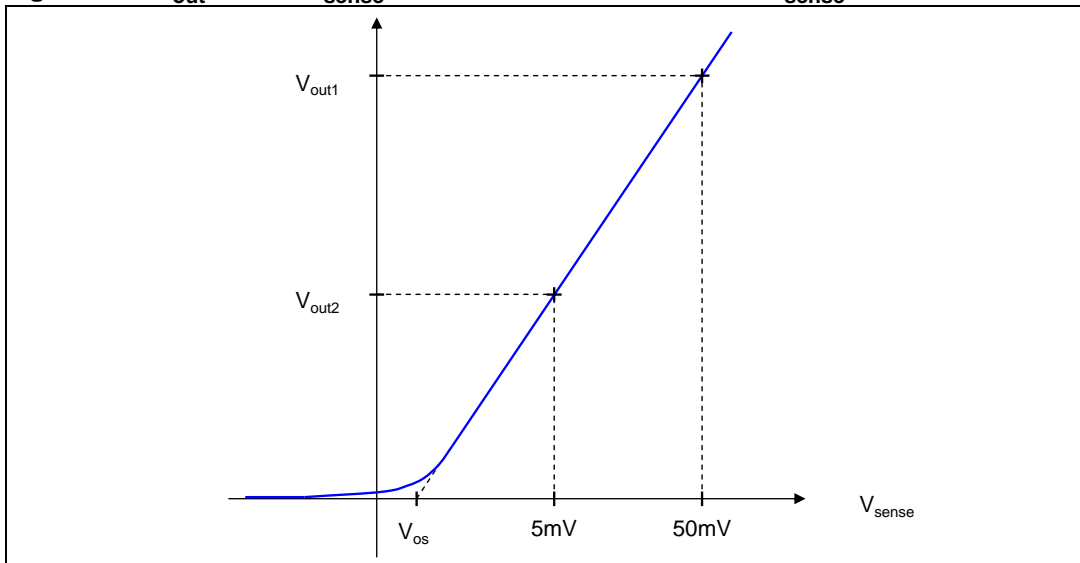

Output voltage drift versus temperature

The output voltage drift versus temperature is defined as the maximum variation of V_{out} with respect to its value at 25°C, over the temperature range. It is calculated as follows:

$$\frac{\Delta V_{out}}{\Delta T} = \max \frac{V_{out}(T_{amb}) - V_{out}(25^\circ C)}{T_{amb} - 25^\circ C}$$

with $T_{min} < T_{amb} < T_{max}$.

Figure 21 provides a graphical definition of output voltage drift versus temperature. On this chart, V_{out} is always comprised in the area defined by dotted lines representing the maximum and minimum variation of V_{out} versus T.

Figure 21. Output voltage drift versus temperature

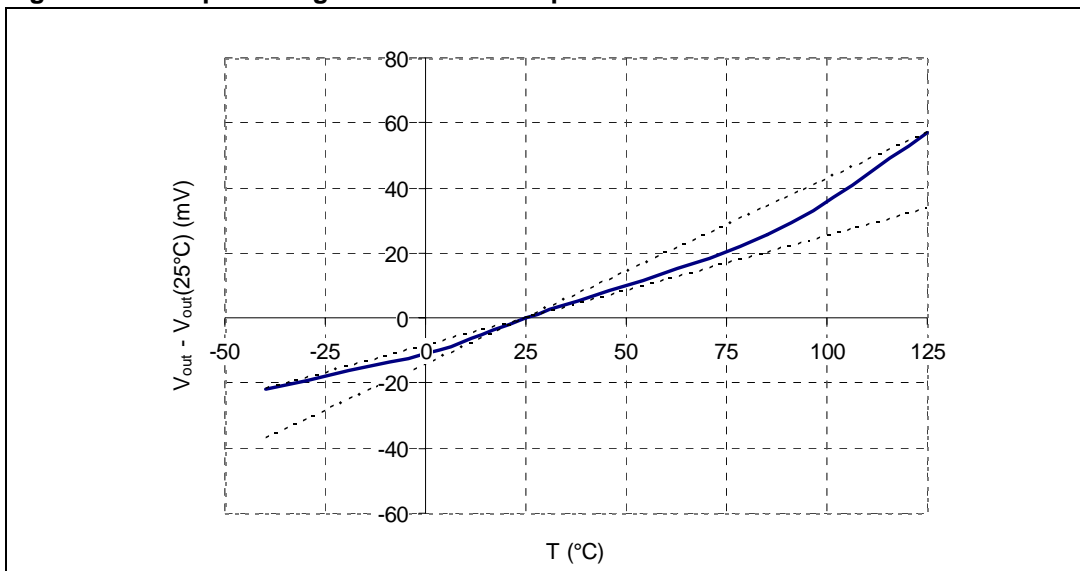

Output voltage accuracy

The output voltage accuracy is the difference between the actual output voltage and the theoretical output voltage. Ideally, the current sensing output voltage should be equal to the input differential voltage multiplied by the theoretical gain, as in the following formula:

$$V_{\text{out-th}} = A_V \cdot V_{\text{sense}}$$

The actual value is very slightly different, mainly due to the effects of:

- the input offset voltage V_{OS} ,
- non-linearity

Figure 22. V_{out} vs. V_{sense} theoretical and actual characteristics

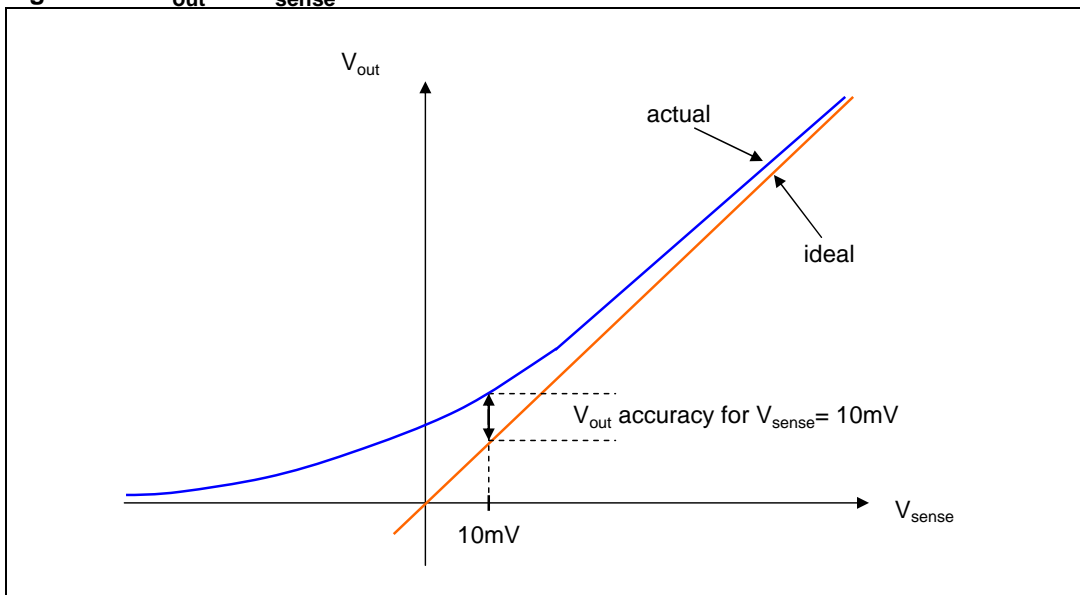

The output voltage accuracy, expressed in percentage, can be calculated with the following formula:

$$\Delta V_{\text{out}} = \frac{\text{abs}(V_{\text{out}} - (A_V \cdot V_{\text{sense}}))}{A_V \cdot V_{\text{sense}}}$$

with $A_V=20\text{V/V}$ for TSC101A, $A_V=50\text{V/V}$ for TSC101B and $A_V=100\text{V/V}$ for TSC101C.

5 Application information

The TSC101 can be used to measure current and to feed back the information to a microcontroller, as shown in [Figure 23](#).

Figure 23. Typical application schematic

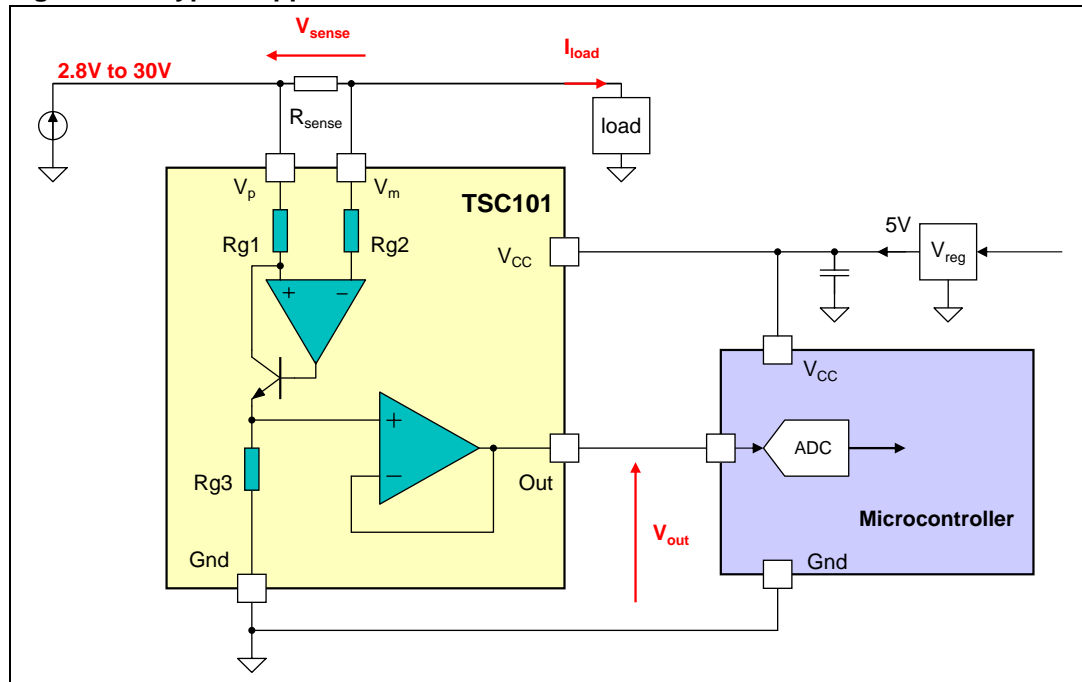

The current from the supply flows to the load through the R_{sense} resistor causing a voltage drop equal to V_{sense} across R_{sense} . The amplifier input currents are negligible, therefore its inverting input voltage is equal to V_m . The amplifier's open-loop gain forces its non-inverting input to the same voltage as the inverting input. As a consequence, the amplifier adjusts current flowing through R_{g1} so that the voltage drop across R_{g1} exactly matches V_{sense} .

Therefore, the drop across R_{g1} is:

$$V_{R_{g1}} = V_{sense} = R_{sense} \cdot I_{load}$$

If $I_{R_{g1}}$ is the current flowing through R_{g1} , then $I_{R_{g1}}$ is given by the formula:

$$I_{R_{g1}} = V_{sense} / R_{g1}$$

The $I_{R_{g1}}$ current flows entirely into resistor R_{g3} (the input bias current of the buffer is negligible). Therefore, the voltage drop on the R_{g3} resistor can be calculated as follows:

$$V_{R_{g3}} = R_{g3} \cdot I_{R_{g1}} = (R_{g3} / R_{g1}) \cdot V_{sense}$$

Because the voltage across the R_{g3} resistor is buffered to the Out pin, V_{out} can be expressed as:

$$V_{out} = (R_{g3} / R_{g1}) \cdot V_{sense} \text{ or } V_{out} = (R_{g3} / R_{g1}) \cdot R_{sense} \cdot I_{load}$$

The resistor ratio R_{g3} / R_{g1} is internally set to 20V/V for TSC101A, to 50V/V for TSC101B and to 100V/V for TSC101C.

The R_{sense} resistor and the R_{g3} / R_{g1} resistor ratio (equal to A_v) are important parameters because they define the full scale output range of your application. Therefore, they must be selected carefully.

6 Package information

In order to meet environmental requirements, STMicroelectronics offers these devices in ECOPACK® packages. These packages have a lead-free second level interconnect. The category of second level interconnect is marked on the package and on the inner box label, in compliance with JEDEC Standard JESD97. The maximum ratings related to soldering conditions are also marked on the inner box label. ECOPACK is an STMicroelectronics trademark. ECOPACK specifications are available at: www.st.com.

Figure 24. SOT23-5 package

Ref.	Dimensions					
	Millimeters			Mils		
	Min.	Typ.	Max.	Min.	Typ.	Max.
A	0.90		1.45	35.4		57.1
A1	0.00		0.15	0.00		5.9
A2	0.90		1.30	35.4		51.2
b	0.35		0.50	13.7		19.7
C	0.09		0.20	3.5		7.8
D	2.80		3.00	110.2		118.1
E	2.60		3.00	102.3		118.1
E1	1.50		1.75	59.0		68.8
e		0.95			37.4	
e1		1.9			74.8	
L	0.35		0.55	13.7		21.6

The figure shows two views of the SOT23-5 package. The left view is a side profile showing dimensions A (total width), A1 (lead width), A2 (lead length), C (lead thickness), and L (lead height). The right view is a top-down view showing dimensions D (package width), E (package height), E1 (package height excluding leads), e (lead pitch), e1 (lead spacing), and b (lead width).

7 Ordering information

Table 9. Order codes

Part number	Temperature range	Package	Packaging	Marking	Gain
TSC101AILT	-40°C, +125°C	SOT23-5	Tape & reel	O104	20
TSC101BILT				O105	50
TSC101CILT				O106	100
TSC101AIYLT ⁽¹⁾	-40°C, +125°C	SOT23-5 (Automotive grade)	Tape & reel	O101	20
TSC101BIYLT ⁽¹⁾				O102	50
TSC101CIYLT ⁽¹⁾				O103	100

1. Qualification and characterization according to AEC Q100 and Q003 or equivalent, advanced screening according to AEC Q001 & Q 002 or equivalent are on-going.

8 Revision history

Table 10. Document revision history

Date	Revision	Changes
5-Mar-2007	Rev 1	First release, preliminary data.
22-Oct-2007	Rev 2	Document status promoted from preliminary data to datasheet. Added test results in electrical characteristics tables. Added electrical characteristics curves.

Please Read Carefully:

Information in this document is provided solely in connection with ST products. STMicroelectronics NV and its subsidiaries ("ST") reserve the right to make changes, corrections, modifications or improvements, to this document, and the products and services described herein at any time, without notice.

All ST products are sold pursuant to ST's terms and conditions of sale.

Purchasers are solely responsible for the choice, selection and use of the ST products and services described herein, and ST assumes no liability whatsoever relating to the choice, selection or use of the ST products and services described herein.

No license, express or implied, by estoppel or otherwise, to any intellectual property rights is granted under this document. If any part of this document refers to any third party products or services it shall not be deemed a license grant by ST for the use of such third party products or services, or any intellectual property contained therein or considered as a warranty covering the use in any manner whatsoever of such third party products or services or any intellectual property contained therein.

UNLESS OTHERWISE SET FORTH IN ST'S TERMS AND CONDITIONS OF SALE ST DISCLAIMS ANY EXPRESS OR IMPLIED WARRANTY WITH RESPECT TO THE USE AND/OR SALE OF ST PRODUCTS INCLUDING WITHOUT LIMITATION IMPLIED WARRANTIES OF MERCHANTABILITY, FITNESS FOR A PARTICULAR PURPOSE (AND THEIR EQUIVALENTS UNDER THE LAWS OF ANY JURISDICTION), OR INFRINGEMENT OF ANY PATENT, COPYRIGHT OR OTHER INTELLECTUAL PROPERTY RIGHT.

UNLESS EXPRESSLY APPROVED IN WRITING BY AN AUTHORIZED ST REPRESENTATIVE, ST PRODUCTS ARE NOT RECOMMENDED, AUTHORIZED OR WARRANTED FOR USE IN MILITARY, AIR CRAFT, SPACE, LIFE SAVING, OR LIFE SUSTAINING APPLICATIONS, NOR IN PRODUCTS OR SYSTEMS WHERE FAILURE OR MALFUNCTION MAY RESULT IN PERSONAL INJURY, DEATH, OR SEVERE PROPERTY OR ENVIRONMENTAL DAMAGE. ST PRODUCTS WHICH ARE NOT SPECIFIED AS "AUTOMOTIVE GRADE" MAY ONLY BE USED IN AUTOMOTIVE APPLICATIONS AT USER'S OWN RISK.

Resale of ST products with provisions different from the statements and/or technical features set forth in this document shall immediately void any warranty granted by ST for the ST product or service described herein and shall not create or extend in any manner whatsoever, any liability of ST.

ST and the ST logo are trademarks or registered trademarks of ST in various countries.

Information in this document supersedes and replaces all information previously supplied.

The ST logo is a registered trademark of STMicroelectronics. All other names are the property of their respective owners.

© 2007 STMicroelectronics - All rights reserved

STMicroelectronics group of companies

Australia - Belgium - Brazil - Canada - China - Czech Republic - Finland - France - Germany - Hong Kong - India - Israel - Italy - Japan - Malaysia - Malta - Morocco - Singapore - Spain - Sweden - Switzerland - United Kingdom - United States of America

www.st.com

