



### SOT-25



### Pin Definition:

1. Enable
2. Output
3. N.C
4. Ground
5. SW

## General Description

The TS1909 is a high efficiency VFM Step-up DC/DC converter for small, low input voltage or battery powered systems with ultra low quiescent supply current. The TS1909 accept a positive input voltage from start-up voltage to  $V_{OUT}$  and convert it to a higher output voltage in the 2.5 to 5V range.

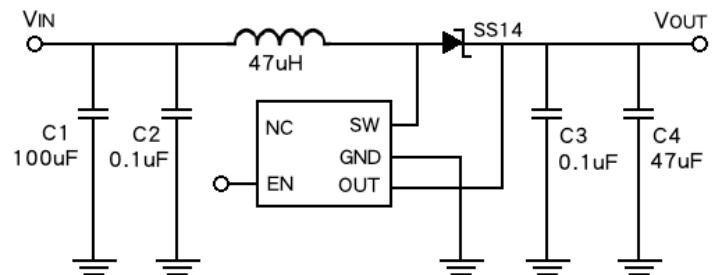
The TS1909 combine ultra low quiescent supply current and high efficiency to give maximum battery life. The high switching frequency and the internally limited peak inductor current permits the use of small, low cost inductors. Only three external components are needed an inductor a diode and an output capacitor. The TS1909 is suitable to be used in battery powered equipment where low noise, low ripple and ultra low supply current are required.

Typical applications are pagers, cameras & video camera, cellular telephones, wireless telephones, palmtop computer, battery backup supplies, battery powered equipment.

## Features

- Very Low Supply Current 22 $\mu$ A (Typ.)
- Maximum shutdown current <1 $\mu$ A
- Output Voltage Accuracy  $\pm 2.5\%$
- Output Current up to 100mA
- Low Ripple and Low Noise
- Very Low Start-up Voltage
- High Efficiency Typ. 87% @  $V_{OUT}=5V$
- Few External Components

## Typical Application Circuit



## Ordering Information

Part No.	Package	Packing
TS1909CX5xx RF	SOT-25	3Kpcs / 7" Reel

Note: Where **xx** denotes voltage option.

Available output: **27**=2.7V, **30**=3V, **33**=3.3V, **50**=5V

## Absolute Maximum Rating

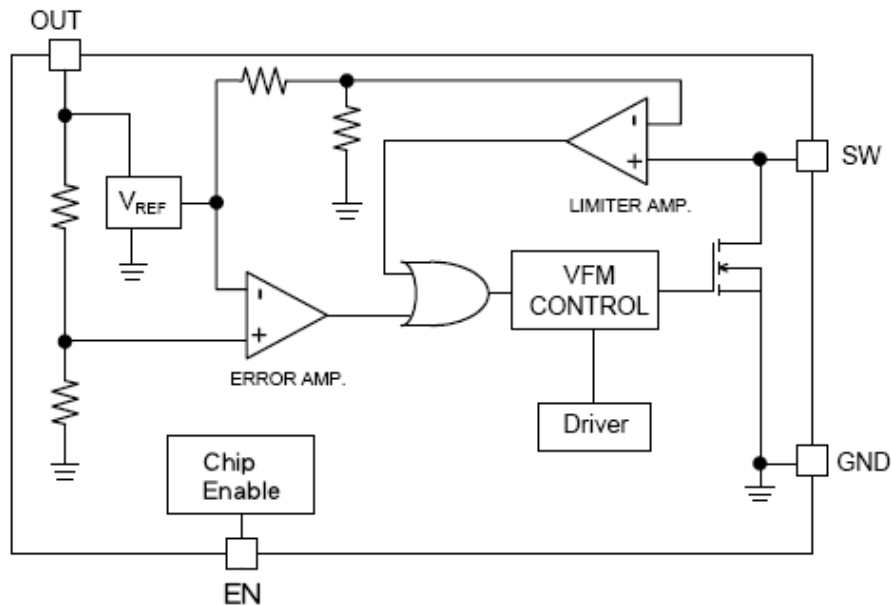
Parameter	Symbol	Limit	Unit
$V_{IN}$ Pin Voltage	$V_{IN}$	5.5	V
SW Voltage	$V_{SW}$	5.5	V
OUT Pin Voltage	$V_{OUT}$	5.5	V
Storage Temperature Range	$T_{STG}$	-40 to +150	$^{\circ}C$
Operating Junction Temperature Range	$T_J$	-20 to +100	$^{\circ}C$
Power Dissipation	$P_D$	$(T_J - T_A) / \theta_{JA}$	mW
Thermal Resistance from Junction to case	$\theta_{JC}$	110	$^{\circ}C/W$
Thermal Resistance from Junction to ambient	$\theta_{JA}$	250	$^{\circ}C/W$

**Note:**  $\theta_{JA}$  is measured with the PCB copper area of approximately 1 inch (Multi-layer) that need connect to GND pin.

**Electrical Specifications** ( $T_a = 25^\circ\text{C}$ ,  $V_{IN}=5\text{V}$ ,  $EN=V_{IN}$ ,  $I_L=0\text{A}$  unless otherwise noted)

Characteristics	Symbol	Conditions	Min	Typ	Max	Units
Output Voltage Accuracy	$\Delta V_{OUT}$		-2.5	--	+2.5	%
Start-up Voltage ( $V_{IN}-V_F$ ) (Note 1)	$V_{START-UP}$	$I_{OUT}=1\text{mA}$ , $V_{IN}=\text{rising from 0 to 2V}$	--	0.8	1.2	V
Hold-on Voltage	$V_{HOLD}$	$I_{OUT}=1\text{mA}$ , $V_{IN}=\text{falling from 2 to 0V}$	0.6	--	--	V
Supply Current	$I_{SUPPLY}$	No Load	--	22	--	$\mu\text{A}$
Internal Switch $R_{DS(ON)}$	$RLX_{(DSON)}$	$ILX=150\text{mA}$	--	850	--	$\text{m}\Omega$
Internal Leakage Current	$ILX_{(Leak)}$	$VLX=4\text{V}$ , Forced $V_{OUT}=3.8\text{V}$	--	--	0.5	$\mu\text{A}$
Maximum Oscillator Frequency	$F_{OSC}$		--	150	--	KHz
Oscillator Duty On	$D_{ON}$	To be measure on SW pin	--	77	--	%
Enable Input Threshold	$V_{ENH}$	Driver ON	0.75	--	--	V
	$V_{ENL}$	Driver OFF	--	--	0.2	
Enable Input Current	$I_{ENH}$	$V_{EN}=V_{IN}$	--	--	0.1	$\mu\text{A}$
	$I_{ENL}$	$V_{EN}=0\text{V}$	--	--	-0.1	
Efficiency	$\eta$	$V_{OUT}=2.5\text{V}\sim 3.0\text{V}$ , $I_{OUT}=50\text{mA}$	--	82	--	%
		$V_{OUT}=3.1\text{V}\sim 4.0\text{V}$ , $I_{OUT}=50\text{mA}$	--	83	--	%
		$V_{OUT}=4.1\text{V}\sim 5.0\text{V}$ , $I_{OUT}=50\text{mA}$	--	87	--	%

**Block Diagram**



### Detailed Description

The TS1909 architecture is built around a VFM CONTROL logic core, switching frequency is set through a built in oscillator.  $T_{ON}$  time is fixed (Typ. 5 $\mu$ S) while  $T_{OFF}$  time is determined by the error amplifier output, a logic signal coming from the comparison made by the Error Amplifier Stage between the signal coming from the output voltage divider network and the internal Band-Gap voltage reference ( $V_{REF}$ ).  $T_{OFF}$  reaches a minimum (Typ. 1.7 $\mu$ S) when heavy load conditions are met (Clock frequency 150KHz). An over current conditions, through the internal power switch, causes a voltage drop  $VLX=R_{DS(ON)} \times ISW$  and the VLX limiter block forces the internal switch to be off, so narrowing  $T_{ON}$  time and limiting internal power dissipation. In this case the switching frequency may be higher than the 150KHz set by the internal clock generator.

VFM control ensures very low quiescent current and high conversion efficiency even with very light loads. Since the Output Voltage pin is also used as the device Supply Voltage, the versions with higher output voltage present an higher internal supply voltage that results in lower power switch  $R_{DS(ON)}$ , slightly greater output power and higher efficiency. Moreover, bootstrapping allows the input voltage to sag to 0.6V (at  $I_{OUT}=1mA$ ) once the system is started. If the input voltage exceeds the output voltage, the output will follow the input, however, the input or output voltage must not be forced above 5.5V.

### Application Information

#### Input/Output Capacitor Selection

The Output Ripple Voltage, as well as the Efficiency, is strictly related to the behavior of these elements. The output ripple voltage is the product of the peak inductor current and the output capacitor Equivalent Series Resistance (ESR). Best performances are obtained with good high frequency characteristics capacitors and low ESR. The best compromise for the value of the Output Capacitance is 47 $\mu$ F Tantalum Capacitor; Lower values may cause higher Output Ripple Voltage and lower Efficiency without compromising the functionality of the device. An Input Capacitor is required to compensate, if present, the series impedance between the Supply Voltage Source and the Input Voltage of the Application.

#### Inductor Selection

A 47 $\mu$ H inductor is recommended for most TS1909 applications. However, the inductance value is not critical, and the TS1909 will work with inductors in the 33 $\mu$ H to 120 $\mu$ H.

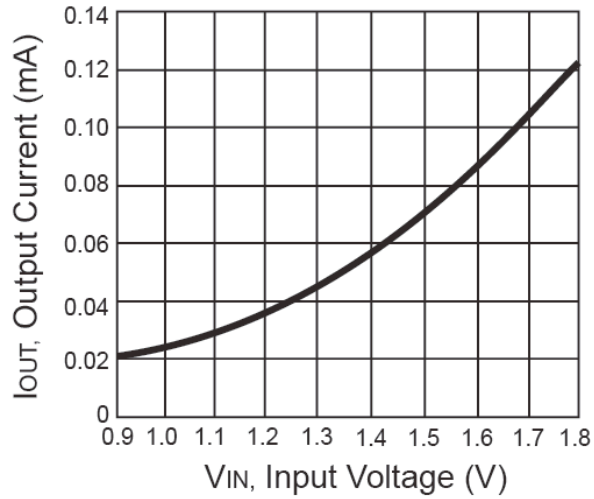
#### Diode Selection

Schottky diodes with higher current ratings usually have lower forward voltage drop, larger diode capacitance and fast reverse recovery, it is the ideal choices for TS1909 applications. The forward voltage drop of a Schottky diode represents the conduction losses in the system, while the diode capacitance (CT or CD) represents the switching losses. For diode selection, both forward voltage drop and diode capacitance need to be considered.

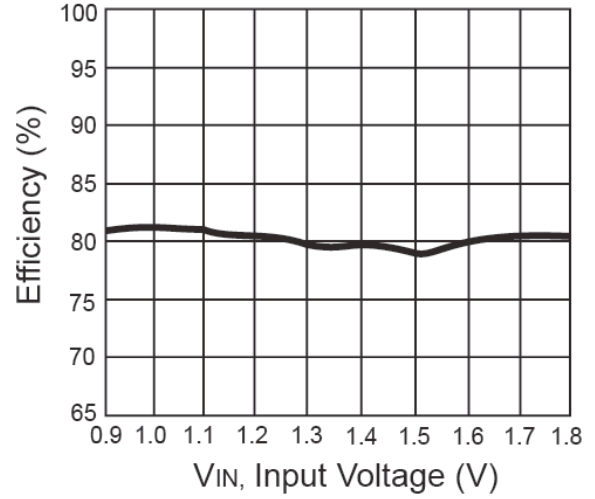
#### PCB layout guide

When laying out the PC board, the following suggestions should be taken to ensure proper operation of the TS1909. These items are also illustrated graphically in below. The power traces, including the GND trace, the SW trace and the VCC trace should be kept short, direct and wide to allow large current flow. Put enough multiply-layer pads when they need to change the trace layer. Do not trace signal line under inductor.

### Electrical Characteristics Curve

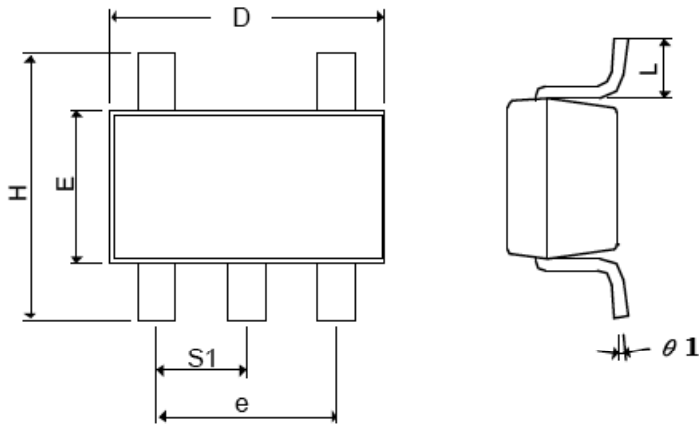


**Figure 1. Output Current vs. Input Voltage**



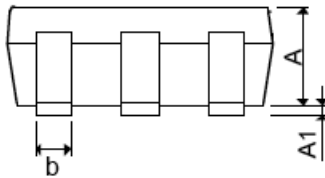
**Figure 2 Efficiency vs. Input Voltage**

**SOT-25 Mechanical Drawing**

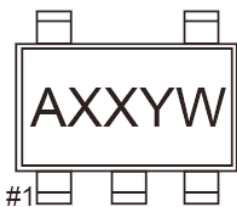


DIM	MILLIMETERS		INCHES	
	MIN	MAX	MIN	MAX.
A+A1	0.09	1.25	0.0354	0.0492
B	0.30	0.50	0.0118	0.0197
C	0.09	0.25	0.0035	0.0098
D	2.70	3.10	0.1063	0.1220
E	1.40	1.80	0.0551	0.0709
E	1.90 BSC		0.0748 BSC	
H	2.40	3.00	0.09449	0.1181
L	0.35 BSC		0.0138 BSC	
Θ1	0°	10°	0°	10°
S1	0.95 BSC		0.0374 BSC	

**Front View**



**Marking Diagram**



- A** = Device Code
- XX** = Voltage Code  
(tc =2.7V, tf =3V, ti =3.3V, tz =5V)
- Y** = Year Code
- W** = Week Code  
01~26 (A~Z)  
27~52 (A~Z)

### Notice

Specifications of the products displayed herein are subject to change without notice. TSC or anyone on its behalf, assumes no responsibility or liability for any errors or inaccuracies.

Information contained herein is intended to provide a product description only. No license, express or implied, to any intellectual property rights is granted by this document. Except as provided in TSC's terms and conditions of sale for such products, TSC assumes no liability whatsoever, and disclaims any express or implied warranty, relating to sale and/or use of TSC products including liability or warranties relating to fitness for a particular purpose, merchantability, or infringement of any patent, copyright, or other intellectual property right.

The products shown herein are not designed for use in medical, life-saving, or life-sustaining applications. Customers using or selling these products for use in such applications do so at their own risk and agree to fully indemnify TSC for any damages resulting from such improper use or sale.