

APPLICATIONS

- Rectification
- Freewheel Diode
- DC Motor Control
- Power Supplies
- Welding
- Battery Chargers

KEY PARAMETERS

V_{RRM}	2800V
$I_{F(AV)}$	1960A
I_{FSM}	31250A

FEATURES

- Double Side Cooling
- High Surge Capability

VOLTAGE RATINGS

Type Number	Repetitive Peak Reverse Voltage V_{RRM} V	Conditions
TR2004SF28	2800	$V_{RSM} = V_{RRM} + 100V$
TR2004SF27	2700	
TR2004SF26	2600	
TR2004SF25	2500	
TR2004SF24	2400	

Lower voltage grades available.

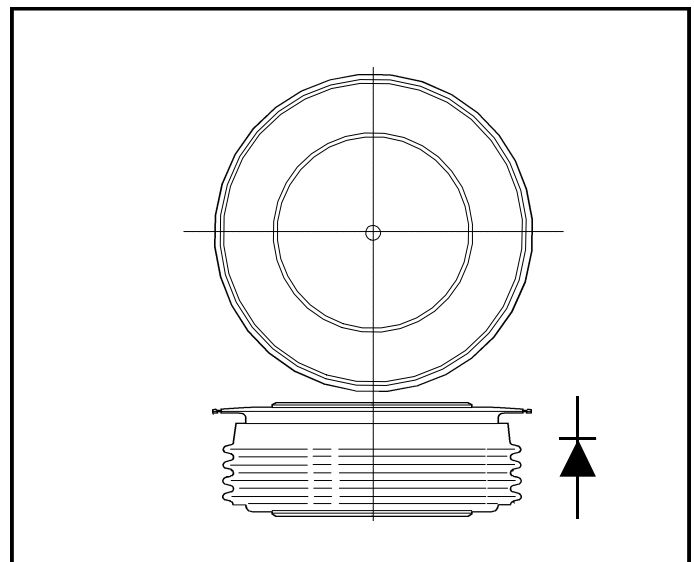

Outline type code: F.
See Package Details for further information.

CURRENT RATINGS

Symbol	Parameter	Conditions	Max.	Units
Double Side Cooled				
$I_{F(AV)}$	Mean forward current	Half wave resistive load, $T_{case} = 100^{\circ}C$	1960	A
$I_{F(RMS)}$	RMS value	$T_{case} = 100^{\circ}C$	3077	A
I_F	Continuous (direct) forward current	$T_{case} = 100^{\circ}C$	2750	A
Single Side Cooled (Anode side)				
$I_{F(AV)}$	Mean forward current	Half wave resistive load, $T_{case} = 100^{\circ}C$	1300	A
$I_{F(RMS)}$	RMS value	$T_{case} = 100^{\circ}C$	2040	A
I_F	Continuous (direct) forward current	$T_{case} = 100^{\circ}C$	1600	A

TR2004SF

SURGE RATINGS

Symbol	Parameter	Conditions	Max.	Units
I_{FSM}	Surge (non-repetitive) forward current	10ms half sine; $T_{case} = 175^{\circ}C$ $V_R = 50\% V_{RRM} - 1/4$ sine	25.0	kA
I^2t	I^2t for fusing		3.12×10^6	A ² s
I_{FSM}	Surge (non-repetitive) forward current	10ms half sine; $T_{case} = 175^{\circ}C$ $V_R = 0$	31.25	kA
I^2t	I^2t for fusing		4.88×10^6	A ² s

THERMAL AND MECHANICAL DATA

Symbol	Parameter	Conditions	Min.	Max.	Units	
$R_{th(j-c)}$	Thermal resistance - junction to case	Double side cooled	dc	-	0.022	$^{\circ}C/W$
		Single side cooled	Anode dc	-	0.038	$^{\circ}C/W$
			Cathode dc	-	0.052	$^{\circ}C/W$
$R_{th(c-h)}$	Thermal resistance - case to heatsink	Clamping force 19.5kN with mounting compound	Double side	-	0.004	$^{\circ}C/W$
			Single side	-	0.008	$^{\circ}C/W$
T_{vj}	Virtual junction temperature	Forward (conducting)		-	185	$^{\circ}C$
		Reverse (blocking)		-	175	$^{\circ}C$
T_{stg}	Storage temperature range		-55	180	$^{\circ}C$	
-	Clamping force		18.0	22.0	kN	

CHARACTERISTICS

Symbol	Parameter	Conditions	Min.	Max.	Units
V_{FM}	Forward voltage	At 3400A peak, $T_{case} = 25^{\circ}C$	-	1.3	V
I_{RRM}	Peak reverse current	At V_{RRM} , $T_{case} = 175^{\circ}C$	-	50	mA
Q_S	Total stored charge	$I_F = 2000A$, $dI_{RR}/dt = 3A/\mu s$,	-	2500	μC
I_{RR}	Peak recovery current	$T_{case} = 175C$, $V_R = 100V$	-	105	A
V_{TO}	Threshold voltage	At $T_{vj} = 175C$	-	0.82	V
r_T	Slope resistance	At $T_{vj} = 175C$	-	0.16	m Ω

CURVES

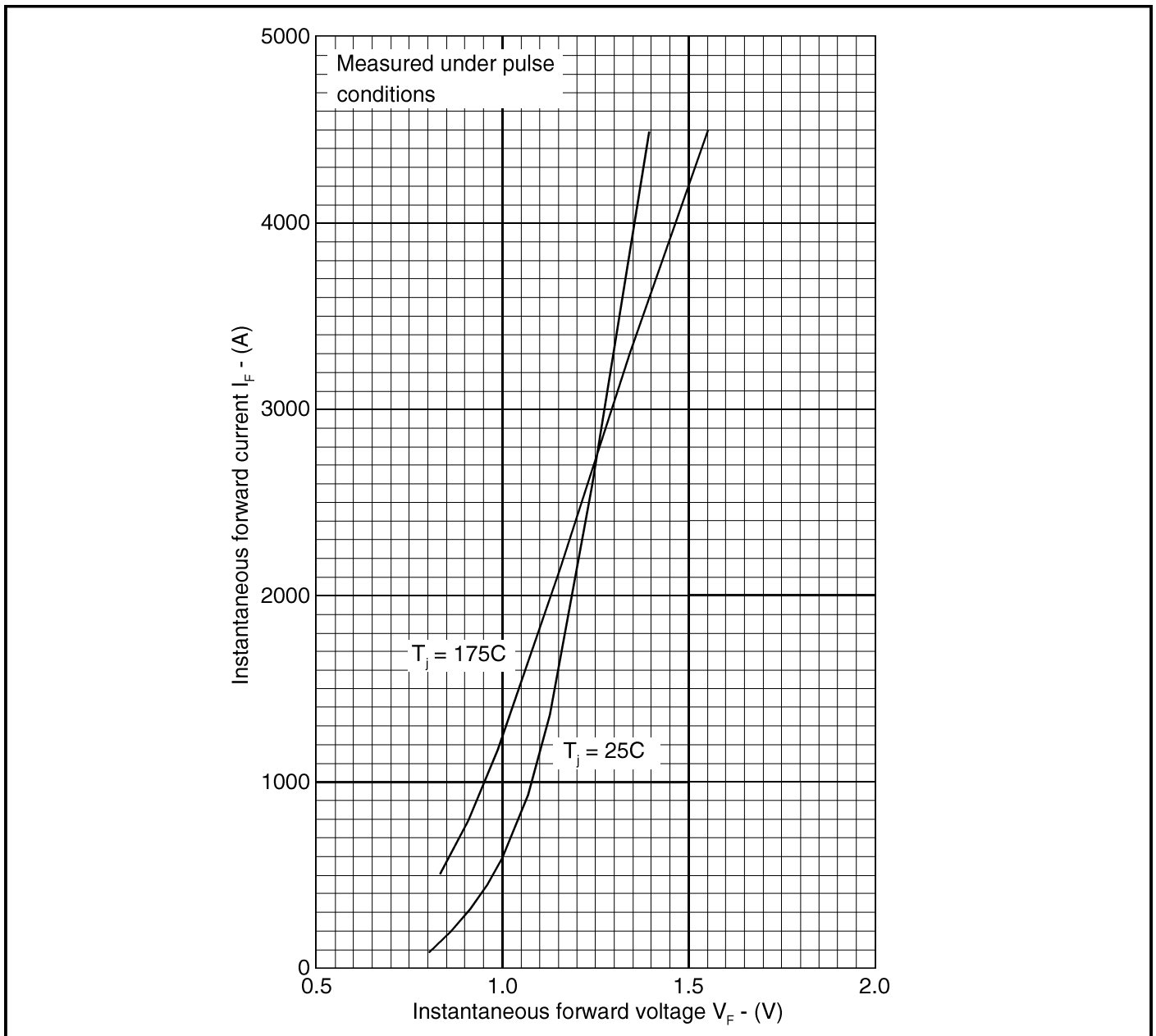

Fig.1 Maximum (limit) forward characteristics

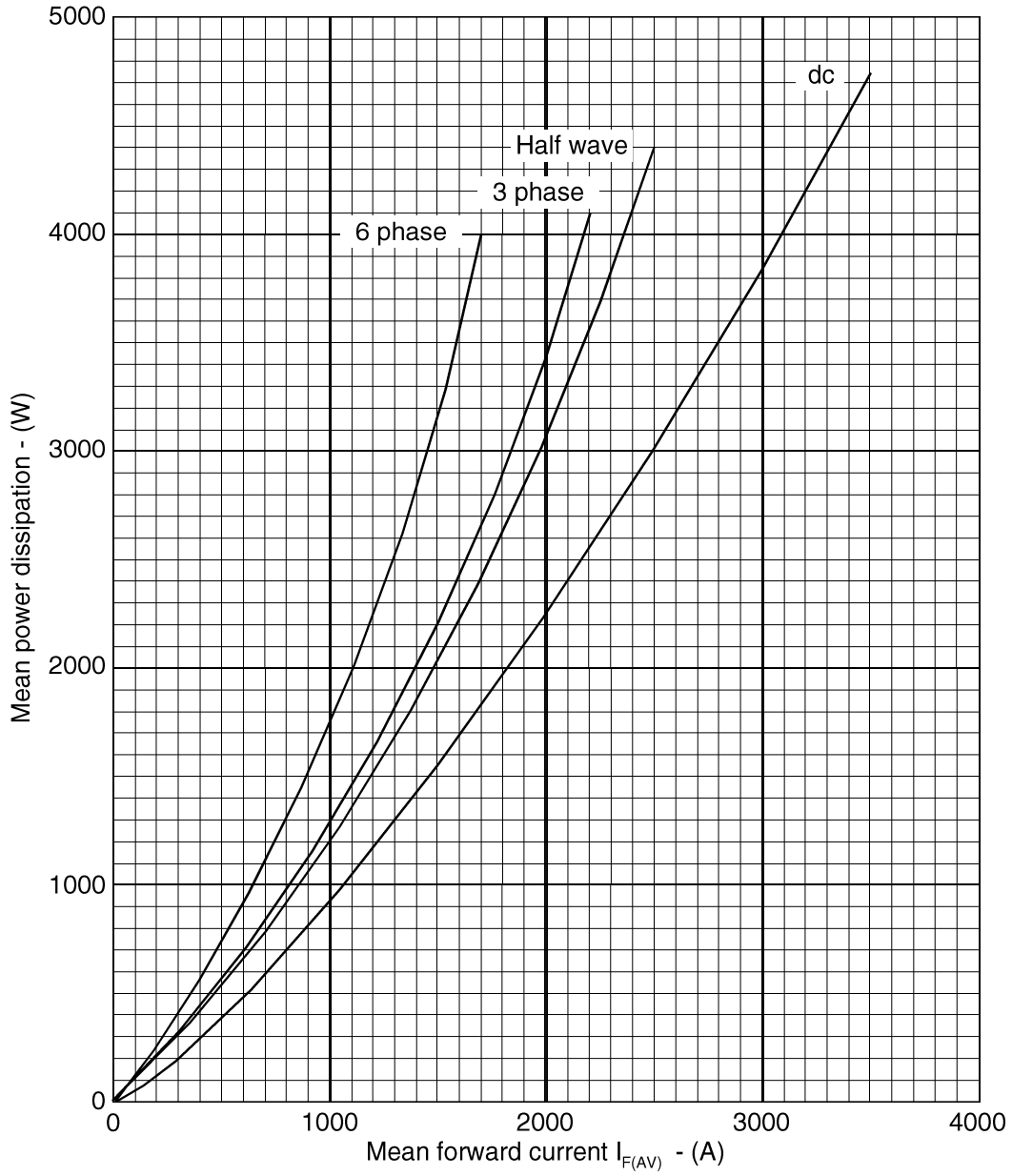

Fig.2 Dissipation curves

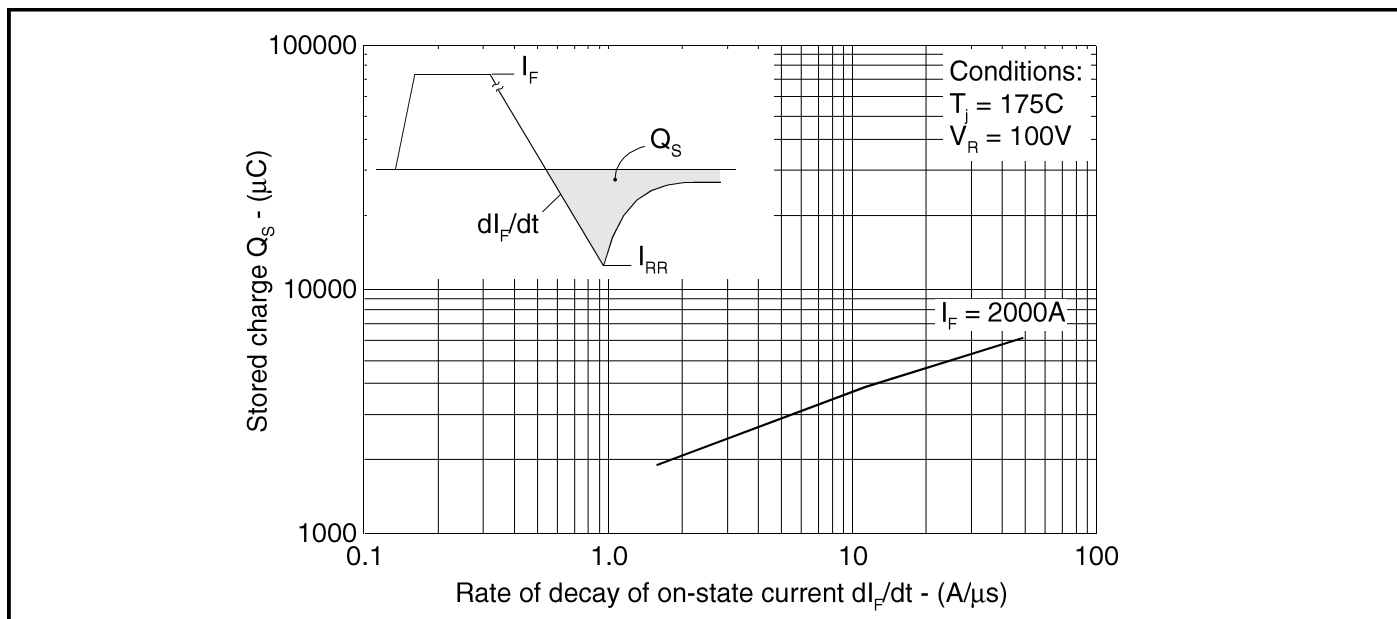

Fig.3 Maximum total stored charge

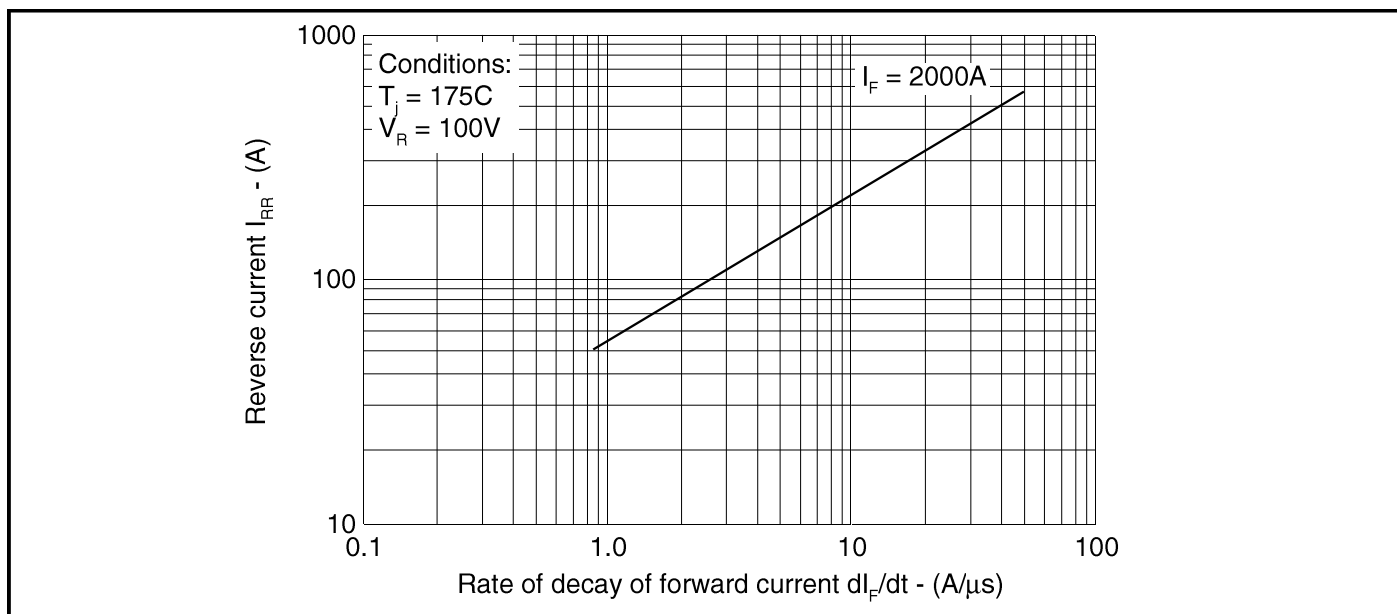

Fig.4 Maximum reverse recovery current

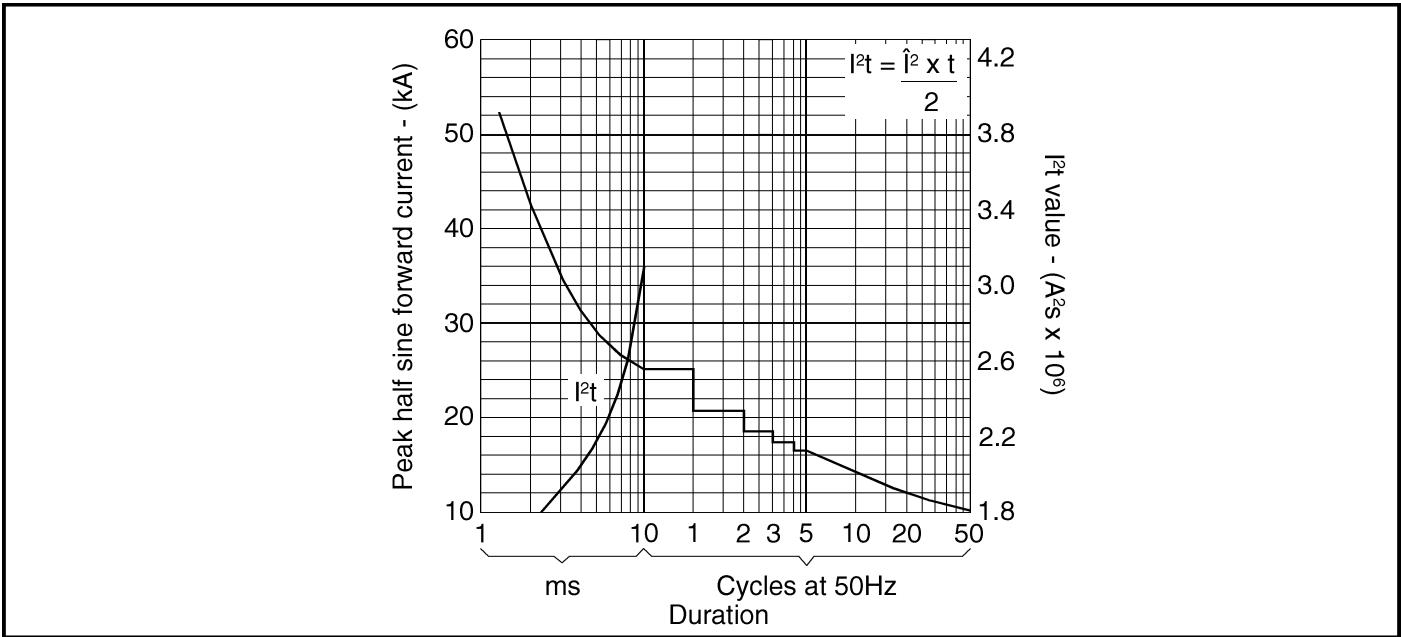

Fig.5 Surge (non-repetitive) forward current vs time ($T_{case} = 175C$)

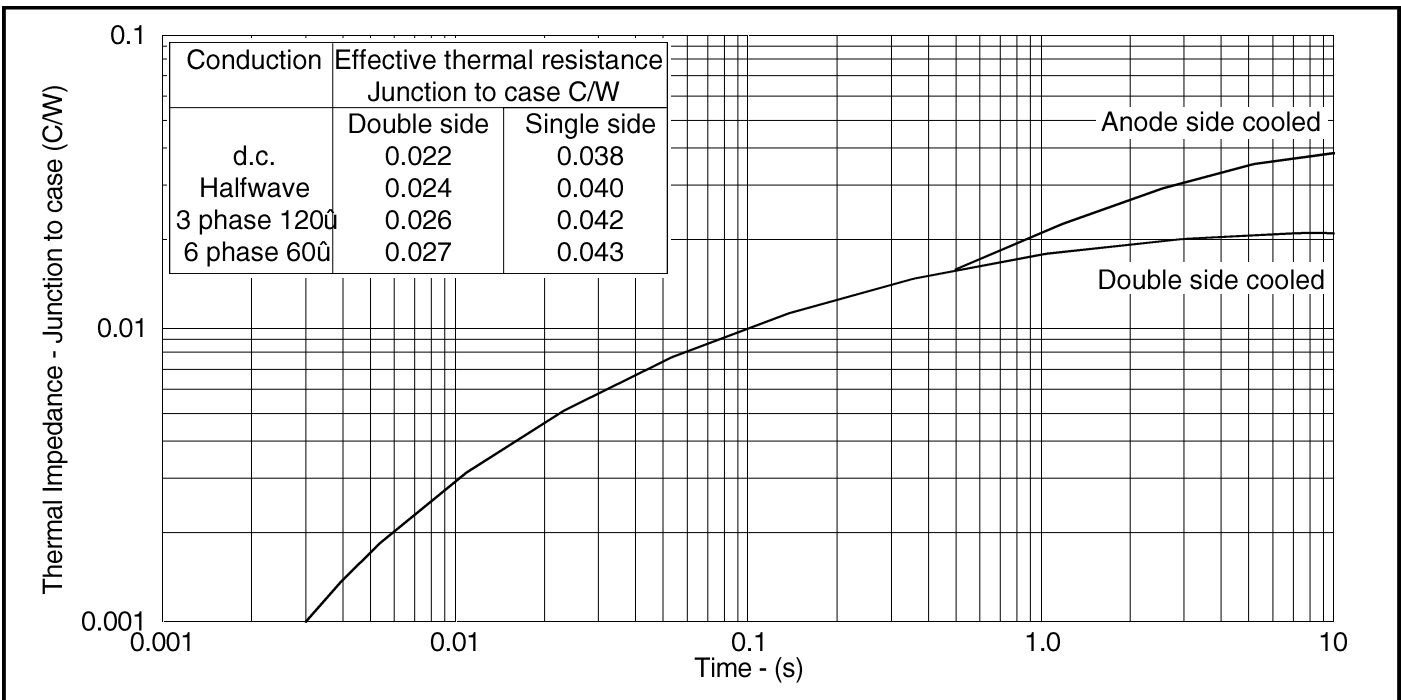

Fig.6 Maximum (limit) transient thermal impedance - junction to case - (C/W)

PACKAGE DETAILS

For further package information, please contact your local Customer Service Centre. All dimensions in mm, unless stated otherwise. DO NOT SCALE.

