

Product Description:

The TQS5200 is a high power, single-pole double-throw switch configured for TX-RX or Antenna Diversity switching applications for the WLAN market. The device exhibits industry-leading insertion loss, isolation and power handling. It requires no fixed supply voltage and operates with a positive control voltage. The switch is manufactured using TriQuint's GaAs pHEMT process and is packaged in an ultra-small, low-profile 1.3mm x 2mm x 0.4mm SLIM-7 package.

Selected Electrical Specifications:

Parameter	min	typ	max	units
Frequency Range	2400	-	2500	MHz
Insertion Loss		0.6	0.8	dB
Isolation	23	28		dB
Return Loss	12.5	15		dB
Input P-1dB		31.5		dBm

Parameter	min	typ	max	units
Frequency Range	4900	-	6000	MHz
Insertion Loss		0.8	1.0	dB
Isolation	23	28		dB
Return Loss	12.5	15		dB
Input P-1dB		29		dBm

Test Conditions: Ta=25°C; Pin=0dBm; Vcntrl=3.0V/0.0V as required

SPDT Switch for Single-band and Dual-band, 802.11a/b/g Systems

Features

- Integrated SPDT Switch for Single-band and Dual-band 802.11a/b/g WLAN Systems
- 1.0 to 6.0 GHz Frequency Coverage
- Low Insertion Loss
- High Isolation
- Positive Control Voltage
- GaAs pHEMT Technology
- Leadless 1.3 x 2.0 x 0.4 mm SMT Package

Applications

- 802.11b WLAN
- 802.11g WLAN
- 802.11a WLAN
- TX-RX Switching
- Antenna Diversity Switching

TQS5200

Preliminary Datasheet

Absolute Maximum Ratings

Parameter	Symbol	Value		Unit
		min	max	
Control Voltage Range	Vcntrl	-5	5	V
RF Input Power	Pin		3	W
Junction Temperature @ 30 dBm input, 25° C	Tj		50	°C
Storage Temperature	T _a	-40	150	°C
Operating Temperature Range	To _{per}	-40	85	°C

DC Electrical Performance

Parameter,	min	typ	max	Unit
Logic Level Low - State 0	0	-	0.2	V
Logic Level High - State 1	2.5	-	5.0	V
Gate Leakage		1	50	uA

General Electrical Characteristics^{1,2}

Parameter	min	typ	max	min	typ	max	units
Frequency Range	2400	-	2500	4900	-	6000	MHz
Insertion Loss		0.6	0.8		0.8	1.0	dB
Isolation	23	28		23	28		dB
Return Loss	12.5	15		12.5	15		dB
Input P-1dB (with Vcntrl=3V/0.0V)		31.5			29		dBm
Harmonics, 2fo, Pin=+20dBm (with Vcntrl=3V/0.0V)		85			80		dBc
Harmonics, 3fo, Pin=+20dBm (with Vcntrl=3V/0.0V)		70			70		dBc

¹Test Conditions: T_a=25°C, Vcntrl=3V/0V unless otherwise noted,

²AC performance is guaranteed at 25 Deg-C,

Applications Information

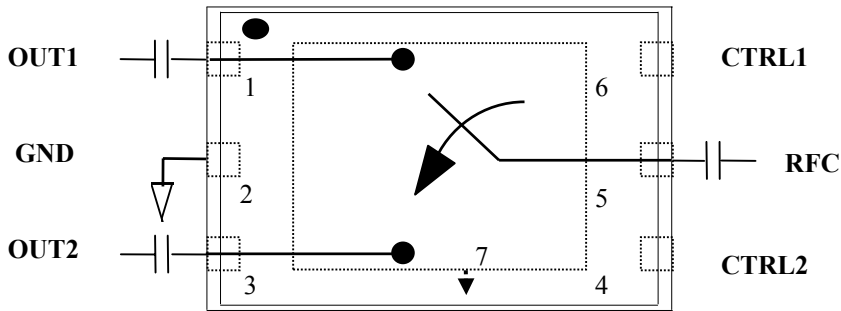

Pin Assignments

PIN	Symbol	Description
1	OUT1	RF Output 1
2	GND	Ground
3	OUT2	RF Output 2
4	CTRL2	RF Output 2 Control
5	RFC	Common RF Port
6	CTRL1	RF Output 1 Control
7	GND	Ground

Truth Table

CTRL1	CTRL2	RFC - OUT1	RFC - OUT2
+2.5V to 5.0V	0.0V +/- 0.2V	ON	OFF
0.0V +/- 0.2V	+2.5V to 5.0V	OFF	ON

TQS5200

Preliminary Datasheet

Evaluation Board – TQS5200 SPDT SW; CSH211 V2.0 Evaluation board

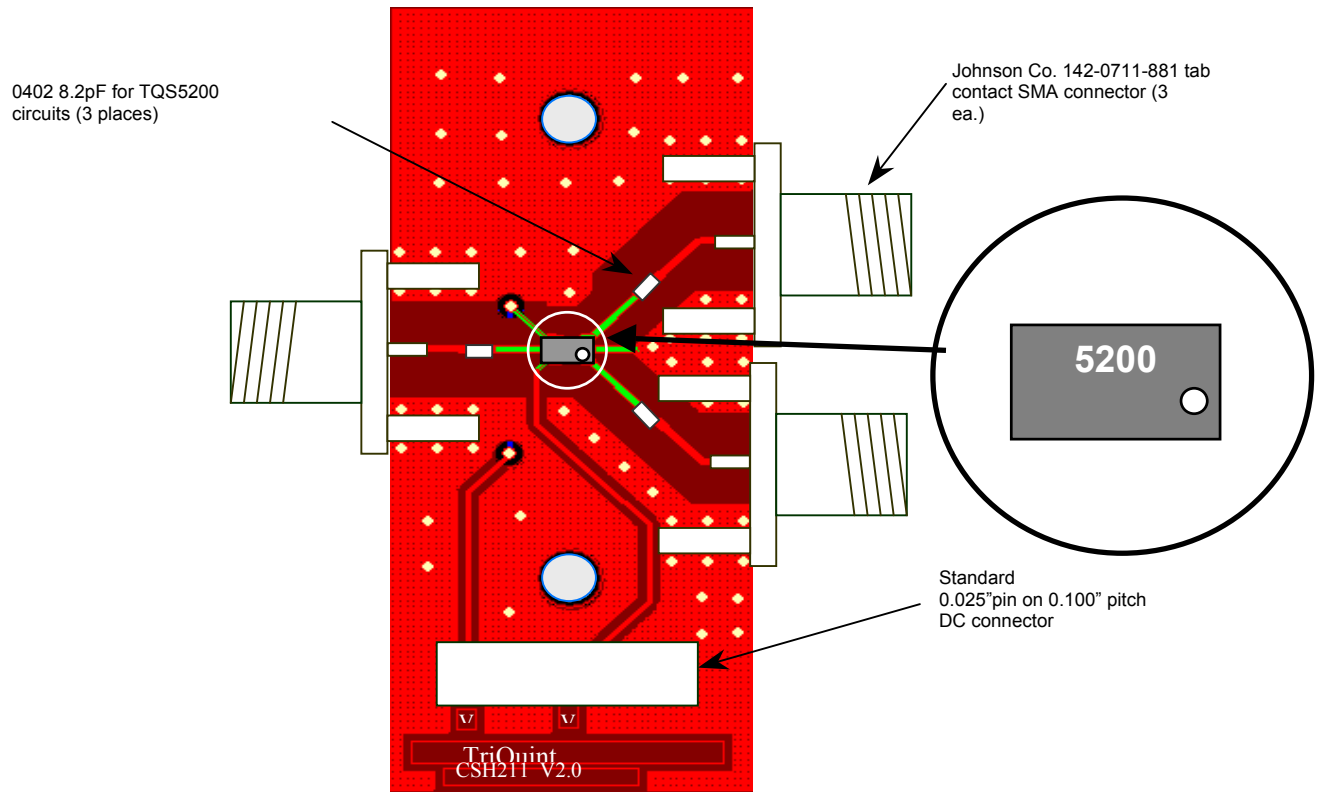

Bill of Materials

Layer/Descriptions
Dielectric: FR4: Er=4.6
Top: 1 oz. Plated Copper
Dielectric 1 : 6 mils
Mid 1: 1 oz. Copper
Dielectric 2: 28 mils
Mid 2: 1 oz. Copper
Dielectric 3: 6 mils
Bottom: 1 oz. Plated Copper

TQS5200 measured performance; in TriQuint CSH211 V2.0 Evaluation Board

Measurement conditions: $T_a = 25^\circ\text{C}$; $V_{ctrl} = 3.0\text{V}/0.0\text{V}$; unless otherwise noted.

Insertion Loss

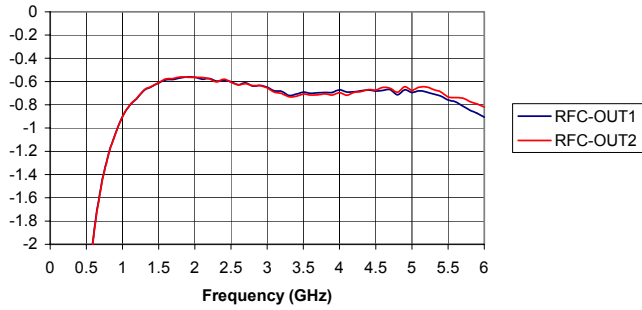

Isolation

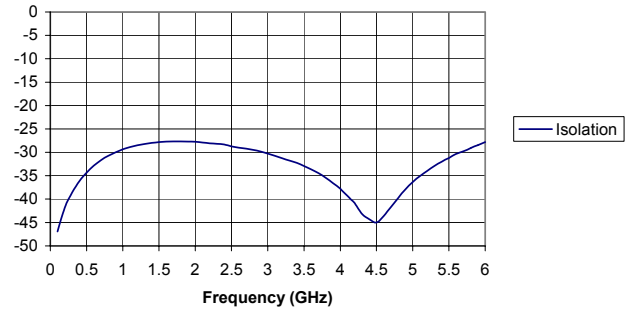

Return Loss

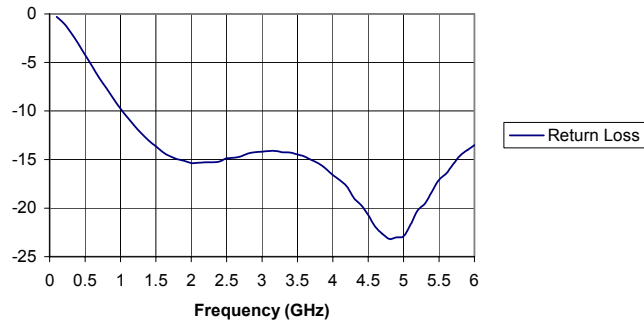

TQS5200

Preliminary Datasheet

TQS5200 Measured Performance; in TriQuint CSH211 V2.0 Evaluation Board- Continued
 Measurement conditions: $T_a = 25^\circ\text{C}$; $V_{ctrl}=3.0\text{V}/0.0\text{V}$, Frequency=2.5GHz; unless otherwise noted.

Insertion Loss versus Input Power

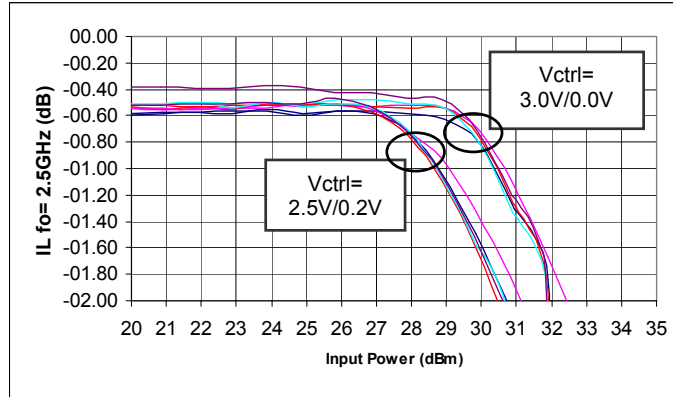

2nd Harmonic versus Input Power

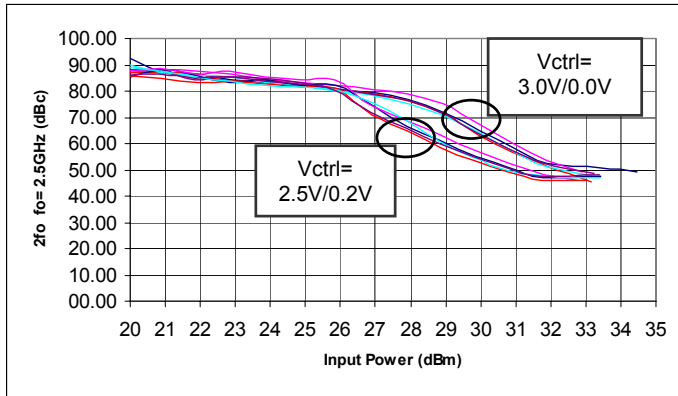

3rd Harmonic versus Input Power

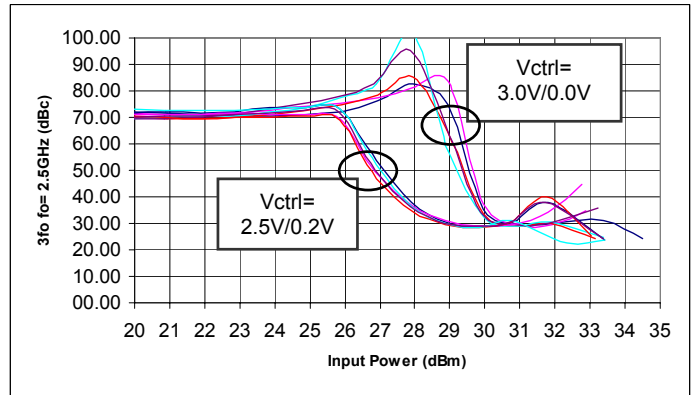

Application Data

Package Outline – SLIM7

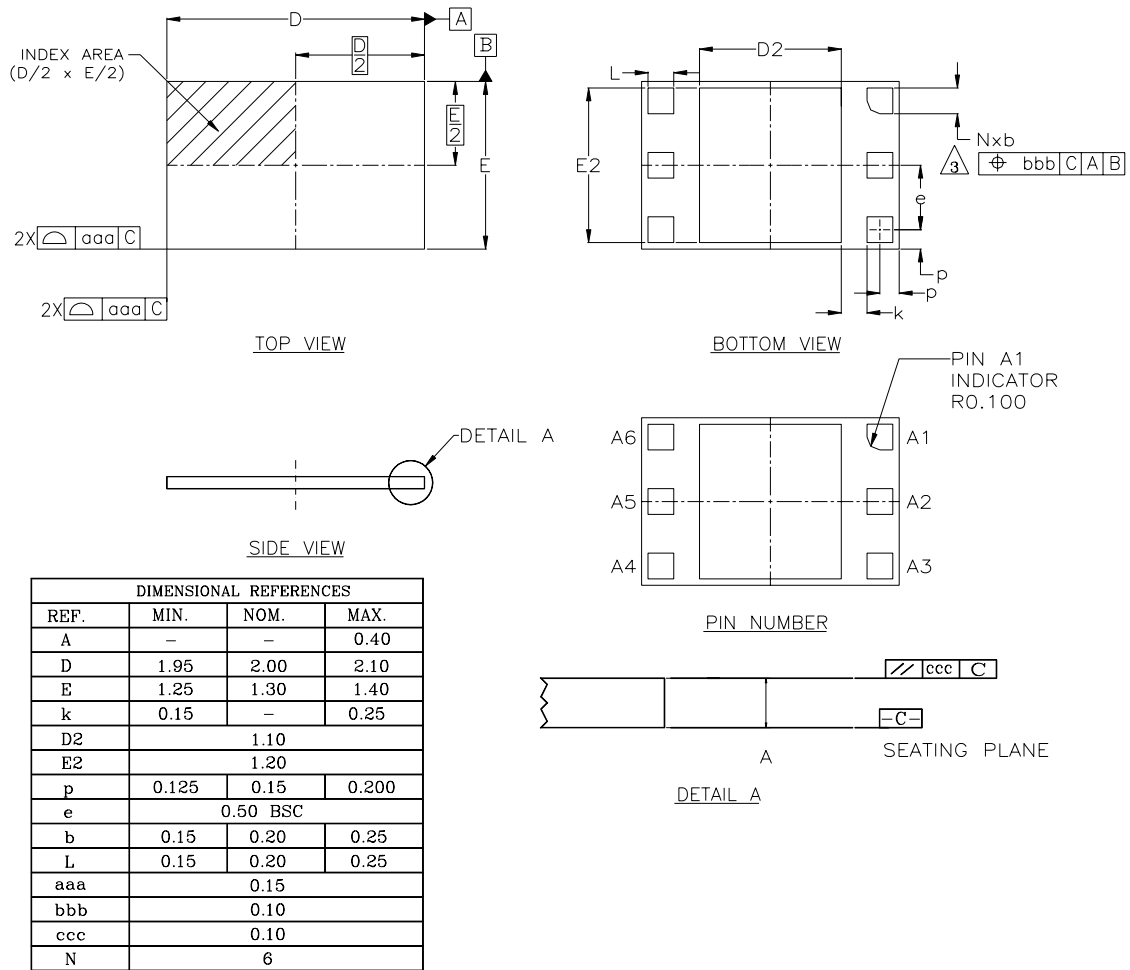

NOTES:

1. ALL DIMENSIONS ARE IN MILLIMETERS.
2. 'e' REPRESENTS THE BASIC LAND GRID PITCH.
3. "N" IS THE TOTAL NUMBER OF I/O
4. DIMENSIONING AND TOLERANCING PER ASME Y14.5M-1994
5. b IS MEASURED AT THE MAXIMUM I/O SIDE LENGTH.
6. LAND DESIGNATION PER JESD 95-1, SPP-002.
7. PACKAGE WARP SHALL BE 0.050MM MAXIMUM.
8. NO METAL CUT ON PAD IS ALLOWED

TQS5200

Preliminary Datasheet

Package Marking

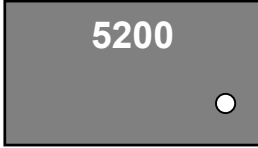

Pin 1

Line 1: 5200
Line 2: XXXX TriQuint Assembly Lot Number
Line 3: Manufacturing year and work-week

Ordering Information:

Type	Marking	Package ¹⁾
TQS5200	5200	SLIM-7

ESD: **E**lectrostatic **d**ischarge sensitive device
Observe handling Precautions!

Additional Information

For latest specifications, additional product information, worldwide sales and distribution locations, and information about TriQuint:

Web: www.triquint.com **Tel:** (503) 615-9000
Email: info_wireless@tqs.com **Fax:** (503) 615-8902

For technical questions and additional information on specific applications:

Email: info_wireless@tqs.com

The information provided herein is believed to be reliable; TriQuint assumes no liability for inaccuracies or omissions. TriQuint assumes no responsibility for the use of this information, and all such information shall be entirely at the user's own risk. Prices and specifications are subject to change without notice. No patent rights or licenses to any of the circuits described herein are implied or granted to any third party.

TriQuint does not authorize or warrant any TriQuint product for use in life-support devices and/or systems.

Copyright © 2003 TriQuint Semiconductor, Inc. All rights reserved.

Revision 1.2 , August 5, 2003