

POSITIVE-TO-NEGATIVE DC-DC CONVERTER

FEATURES

- Positive-to-Negative Converter
- Adjustable Output Voltage
- On/Off Control
- Thermal Protection Sensor
- Broad Operating Voltage Range
- Miniature Package (SOT-23L)

APPLICATIONS

- Pagers
- Cassette Recorders
- Cordless Telephones
- Portable Instrumentation
- Radio Control Systems
- Battery Operated Equipment
- Local Area Network (LAN) Receivers

DESCRIPTION

The TK11830 is a positive-to-negative DC-DC converter. This IC converts a positive input voltage into a regulated negative output voltage. This DC-DC converter features an On/Off function with an active low control. The internal voltage reference provides a stable output voltage which can be set from -0.5 to -12.5 V. The thermal protection feature provides oscillator shutdown in the event of an overload condition. The wide input voltage range of 2.5 to 15 V and a 60 mA output current capability allow flexible operation in a large number of applications.

The TK11830 is available in a miniature SOT-23L surface mount package. Optimized Toko inductors are available.

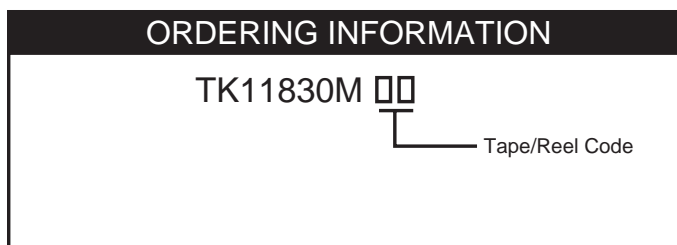
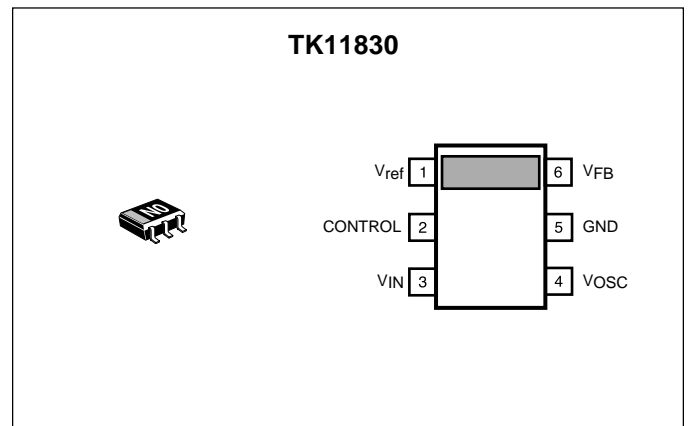

TAPE/REEL CODE
TL: Tape Left

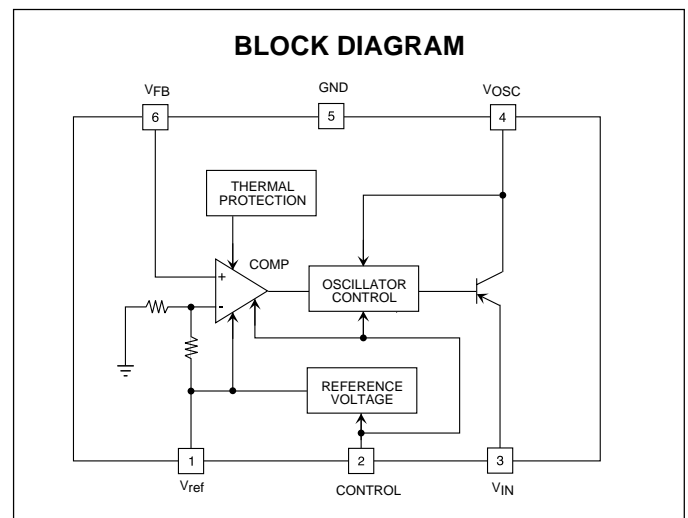

TK11830

ABSOLUTE MAXIMUM RATINGS

Supply Voltage	16 V	Operating Temperature Range	-20 to +75 °C
Operating Voltage	Min. 2.5 V	Junction Temperature	150 °C
Power Dissipation (Note 1)	400 mW	Lead Soldering Temperature (10 s)	235 °C
Storage Temperature Range	-55 to +150 °C		

TK11830 ELECTRICAL CHARACTERISTICS

Test Conditions: $V_{IN} = 5\text{ V}$, $L = 470\ \mu\text{H}$, $T_A = 25\text{ °C}$, unless otherwise specified.

SYMBOL	PARAMETER	TEST CONDITIONS	MIN	TYP	MAX	UNITS
V_{IN}	Input Voltage	$V_{IN} + V_{OUT} \leq 16\text{ V}$	2.5		15	V
V_{ref}	Reference Voltage		1.23	1.28	1.33	V
ΔV_{ref}	Temperature Coefficient of Reference Voltage	$T_A = -30\text{ to }+80\text{ °C}$		± 0.1		mV/°C
$I_{IN(OFF)}$	Input Current at Shutdown	$R_{CONT} = 300\text{ k}\Omega$, Output OFF, $V_{IN} = 5\text{ V}$		25	100	μA
Line Reg	Line Regulation	$V_{IN} = 2.5\text{ to }10\text{ V}$, $V_{OUT} = -5\text{ V}$, $I_{OUT} = 20\text{ mA}$		10	50	mV
Load Reg	Load Regulation	$V_{OUT} = -5\text{ V}$, $I_{OUT} = 1\text{ to }50\text{ mA}$		20	100	mV
I_{OUT}	Output Current	$V_{OUT} = -5\text{ V}$	50	60		mA
ON/OFF CONTROL TERMINAL						
I_{CONT}	Control Terminal Current	$V_{CONT} = 0.4\text{ V}$, $R_{CONT} = 300\text{ k}\Omega$			0.2	μA
		$V_{CONT} = 5.0\text{ V}$, $R_{CONT} = 300\text{ k}\Omega$		3.0		μA
$V_{CONT(ON)}$	Control Voltage (ON)	$R_{CONT} = 300\text{ k}\Omega$, Output ON			0.4	V
$V_{CONT(OFF)}$	Control Voltage (OFF)	$R_{CONT} = 300\text{ k}\Omega$, Output OFF	2.2			V

Note 1: Power dissipation is 400 mW (internally limited) when mounted as recommended. Derate at 3.2 mW/°C for operation above 25 °C.

Gen Note: Output capacitor should have low ESR at reduced temperatures if used below 0 °C.

Gen Note: Parameters with min. or max. values are 100% tested at $T_A = 25\text{ °C}$.

TEST CIRCUIT

Note: Toko Inductor (470 μ H): 646CY-471M
 or 636CE-471K (D73C)
 $V_{OUT} = (V_{ref} / 5) \times [1 - 4 \times (R_2 / R_1)]$,
 where $V_{ref} = 1.28$ V

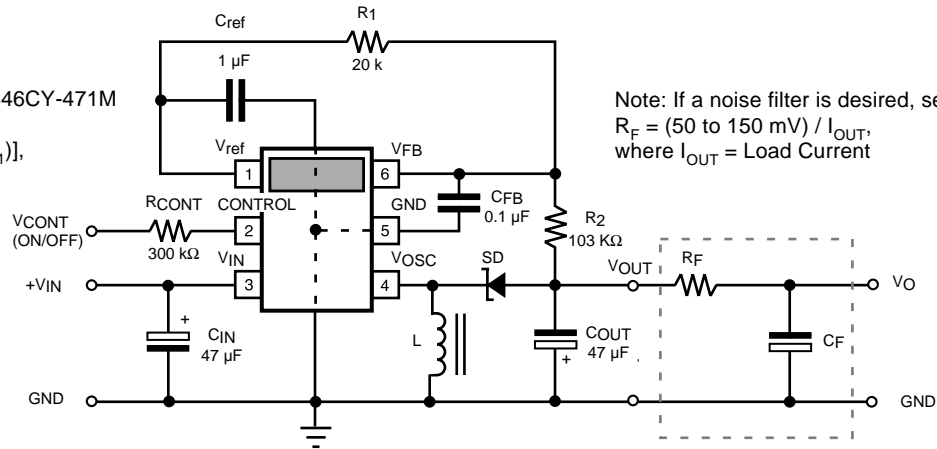

TYPICAL PERFORMANCE CHARACTERISTICS

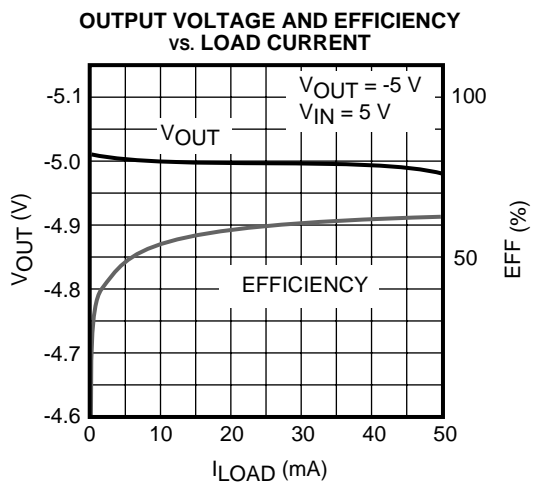
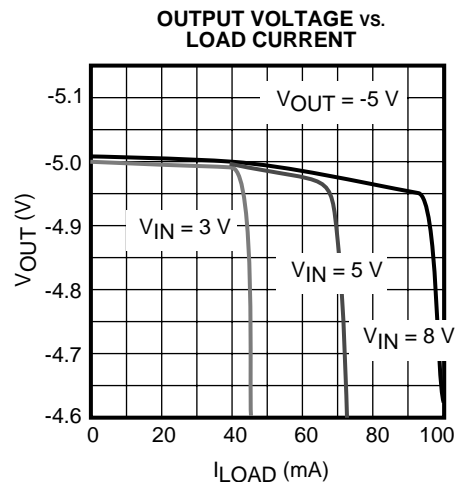
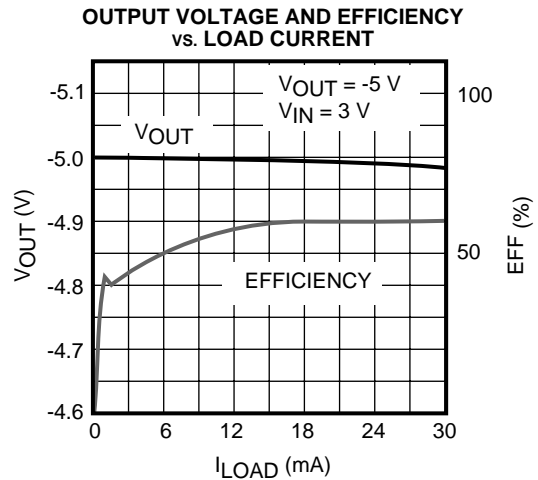
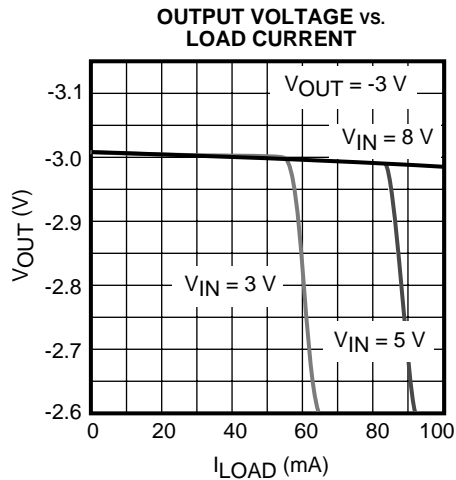

TYPICAL PERFORMANCE CHARACTERISTICS (CONT.)

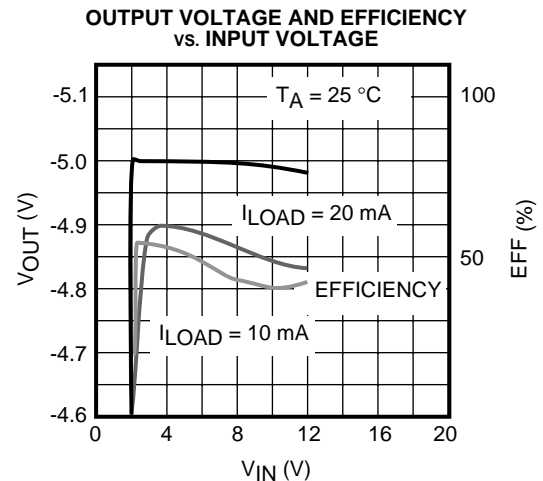
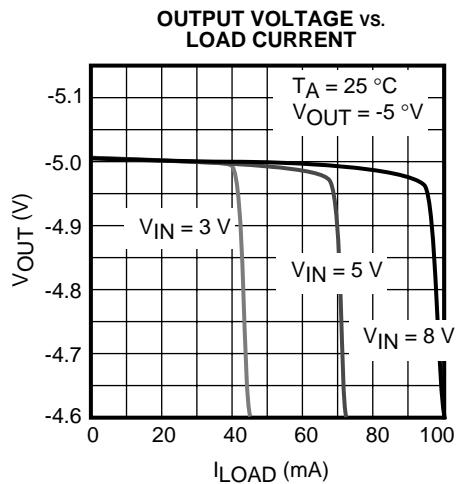
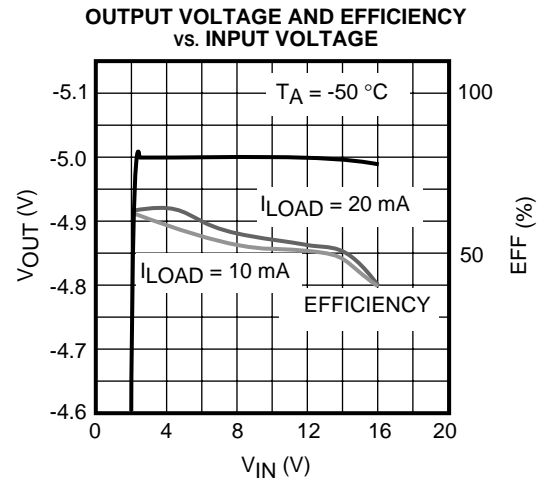
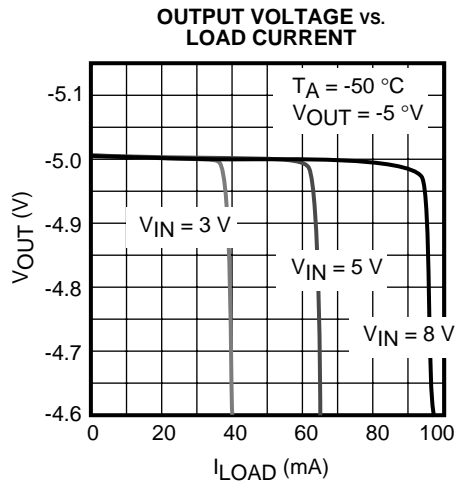
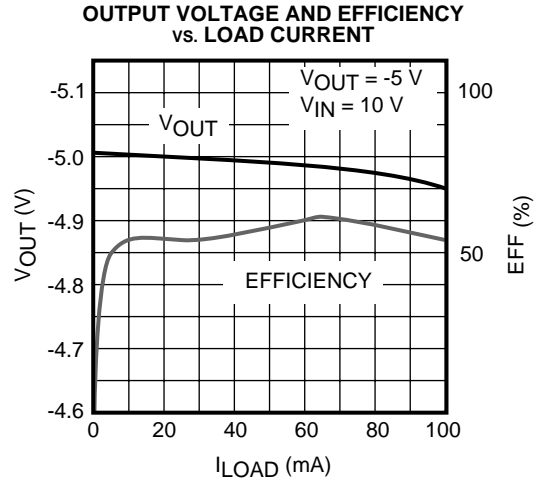
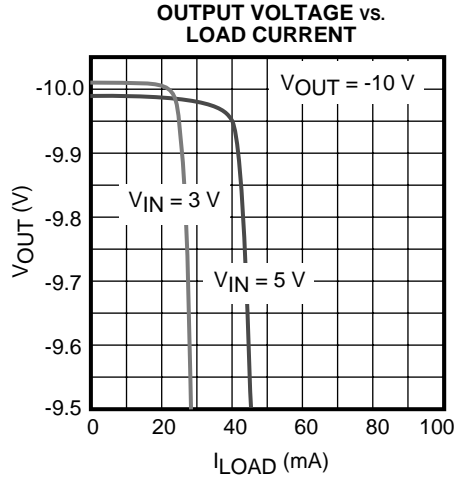

TYPICAL PERFORMANCE CHARACTERISTICS (CONT.)

OUTPUT VOLTAGE vs. LOAD CURRENT

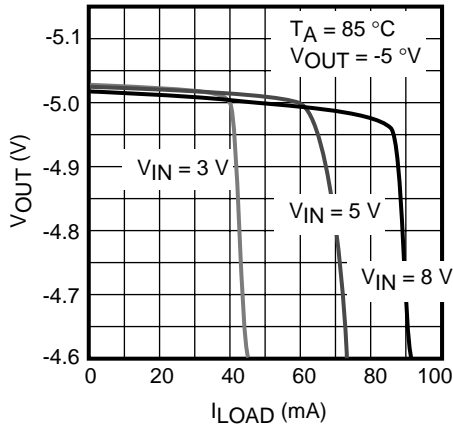

OUTPUT VOLTAGE AND EFFICIENCY vs. INPUT VOLTAGE

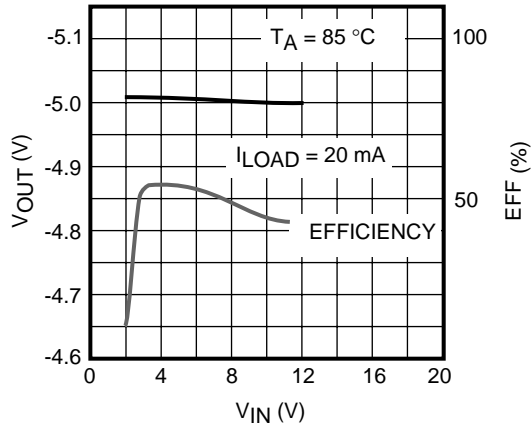

OUTPUT VOLTAGE vs. INPUT VOLTAGE

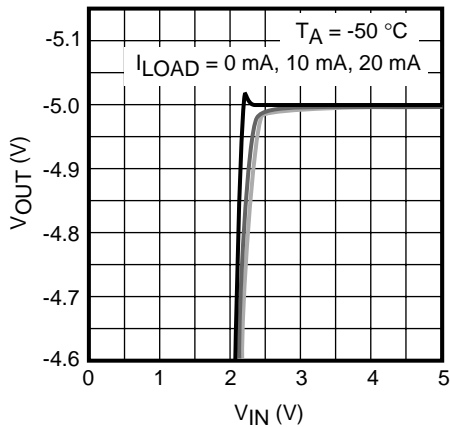

INPUT CURRENT (SHUTDOWN) vs. INPUT VOLTAGE

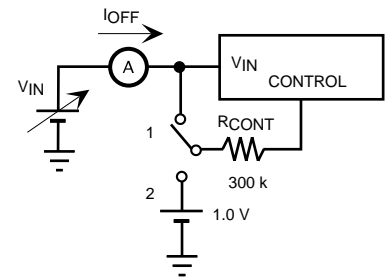
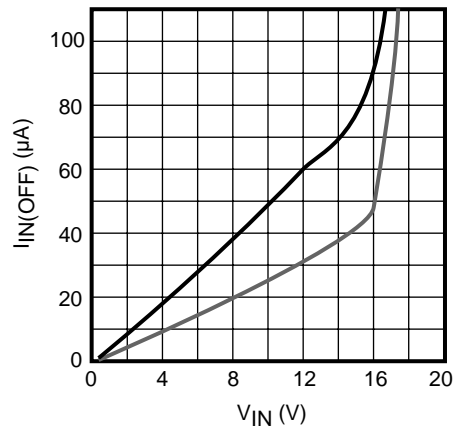

OUTPUT VOLTAGE vs. INPUT VOLTAGE

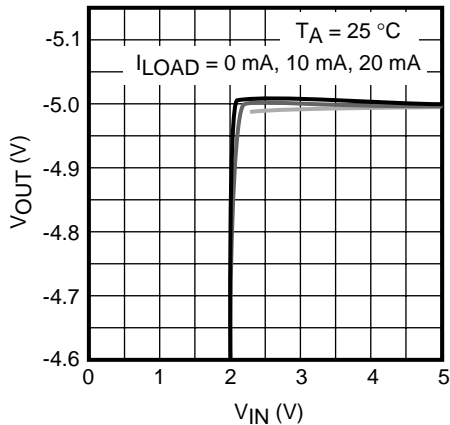

OUTPUT VOLTAGE AND CONTROL CURRENT vs. CONTROL VOLTAGE

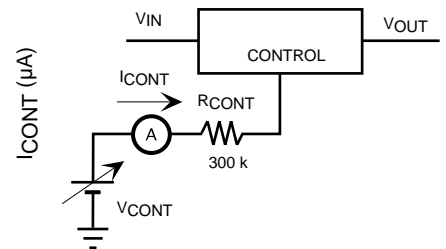
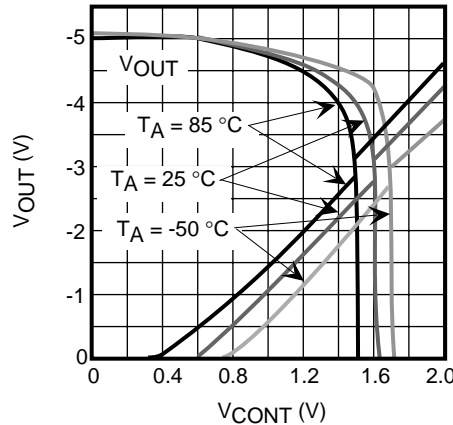

TYPICAL PERFORMANCE CHARACTERISTICS (CONT.)

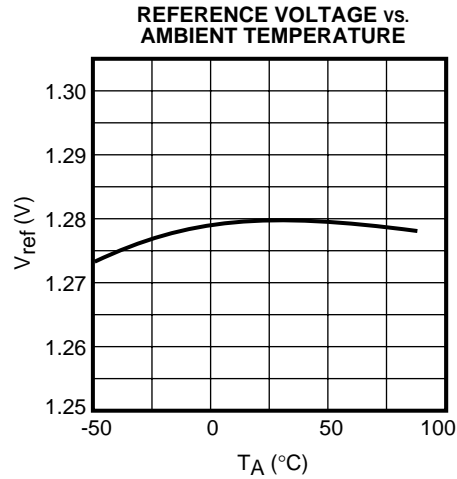
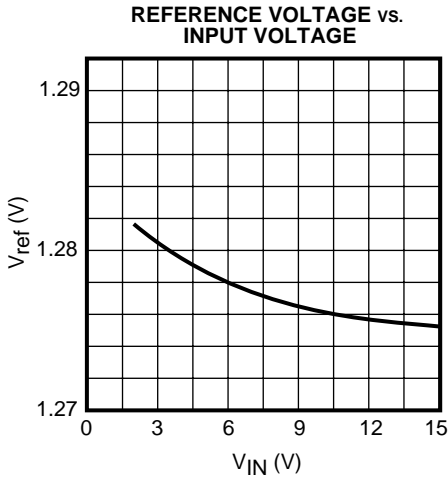
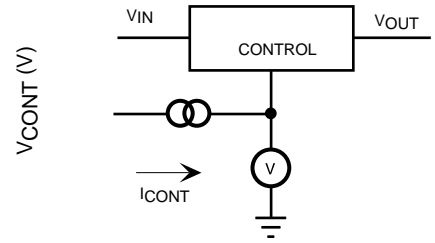
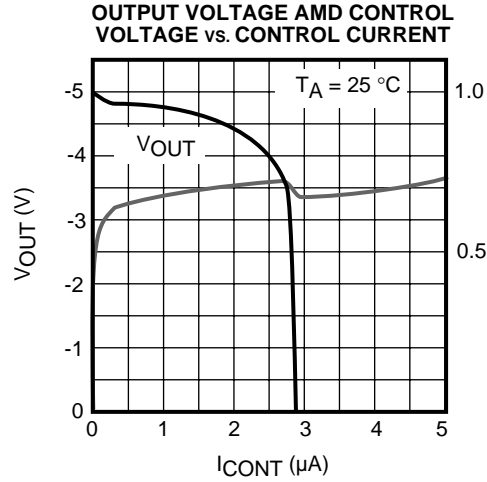
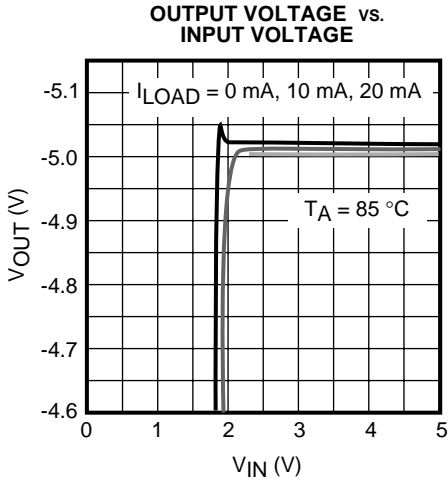

CIRCUIT OPERATION

The TK11830 operates with a continuous mode oscillator. The circuit operates by detecting the difference between the set output voltage and the internal bandgap reference. This is used to vary the oscillator frequency in response to load current. The output voltage is regulated by controlling the power transistor switch current; this maintains a constant charge on the output capacitor.

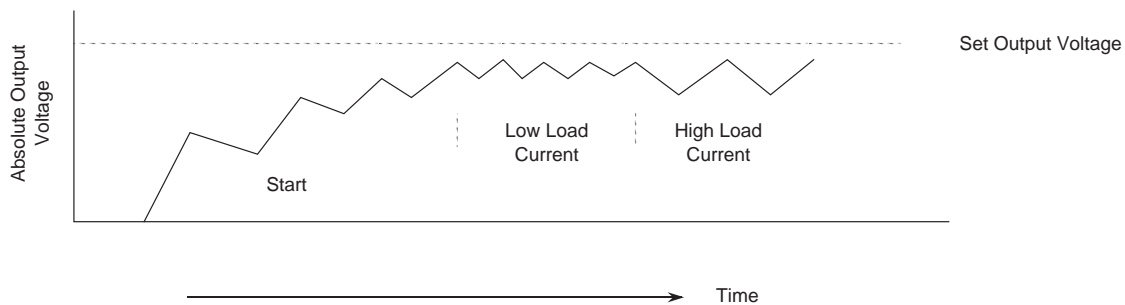
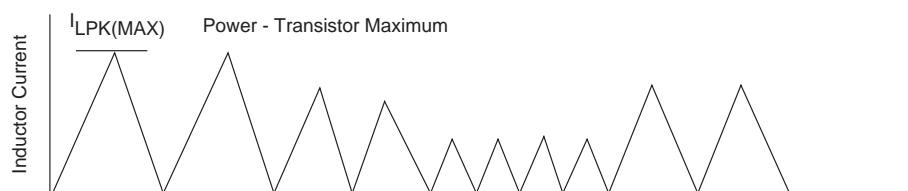
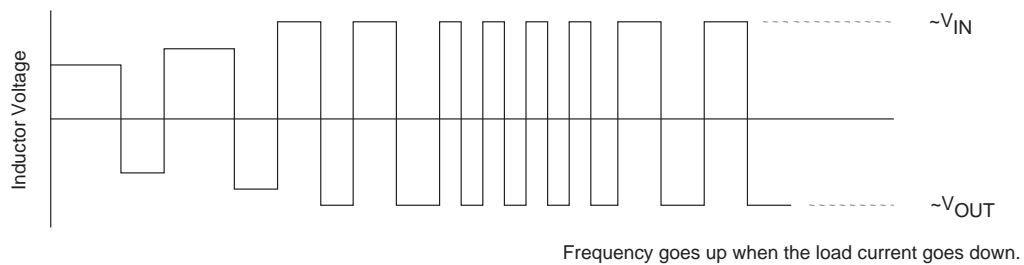

CIRCUIT OPERATION (CONT.)

POLARITY-INVERTING OPERATION

- V_{SAT} Power Transistor Saturation Voltage
- V_F Diode Forward Voltage Drop
- I_L Inductor Current
- I_C Capacitor Current
- I_{LOAD} Load Current
- V_L Inductor Voltage

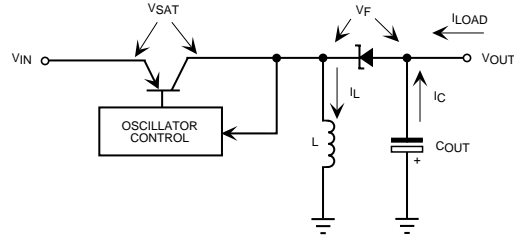

where:

$V_L = L \times (di_L / dt)$ and $V_L = a$ constant value: $I_L = (V_L / L) \times t$

During the charge cycle:

(1) $I_{LPK} = [(V_{IN} - V_{SAT}) \times t_{ON}] / L$

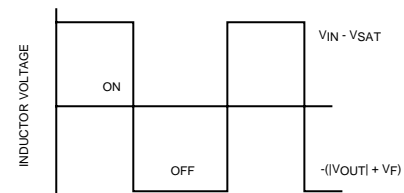

During the discharge cycle:

(2) $I_{LPK} = [(|V_{OFF}| + V_F) \times t_{OFF}] / L$
 ($I_L = 0$ after t_{OFF})

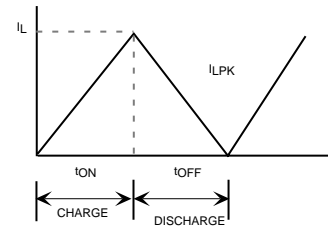

From (1) and (2):

(3) $t_{ON} / t_{OFF} = (|V_{OUT}| + V_F) / (V_{IN} - V_{SAT})$

When $I_L = I_C + I_{LOAD}$ and output voltage are in a steady state, the change of the charge/discharge must be equivalent, so:

$\Delta Q^+ = \Delta Q_1^- + \Delta Q_2^-$

And:

(4) $I_{LPK} = 2 \times I_{LOAD} \times [(t_{ON} / t_{OFF}) + 1]$

Ripple Voltage:

(5) $V_{RIPPLE} = \Delta Q^+ / C_{OUT}$
 $= (I_{LPK} - I_{LOAD})^2 \times t_{OFF} / 2C_{OUT} \times I_{LPK}$
 $\sim I_{LOAD} \times t_{ON} / C_{OUT}$

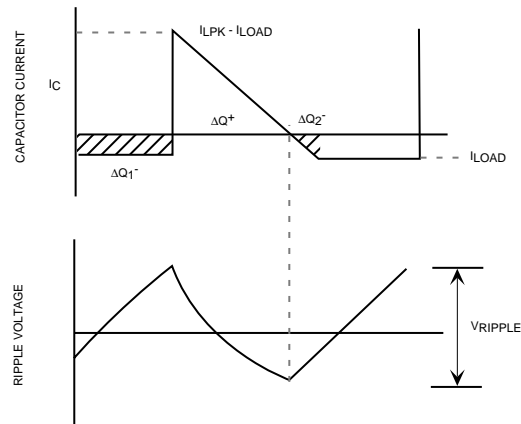

CIRCUIT OPERATION (CONT.)

Oscillator Frequency:

$$f = 1/(t_{ON} + t_{OFF})$$

Where:

$$t_{ON} = L \times [I_{LPK} / (V_{IN} - V_{SAT})]$$

And:

$$t_{OFF} = L \times [I_{LPK} / (|V_{OUT}| + V_F)]$$

Therefore:

$$f = \frac{1}{I_{LPK} L \times \left(\frac{1}{V_{IN} - V_{SAT}} + \frac{1}{|V_{OUT}| + V_F} \right)}$$

$$= \frac{(V_{IN} - V_{SAT})^2 (|V_{OUT}| + V_F)}{2I_{LOAD} (V_{IN} - V_{SAT} + |V_{OUT}| + V_F)^2} \times \frac{1}{L}$$

The ESR of the capacitor and the effect of the input voltage difference for the comparator function are added to V_{RIPPLE} . The maximum inductor current is limited by the power transistor switch capacity: $I_{LPK(MAX)} \sim 300$ mA.

Output Voltage is as follows:

$$V_{OUT} = (V_{ref} / 5) \times (1 - 4 \times R_2 / R_1)$$

where: $V_{ref} = 1.28$ V

R_3, R_4 : IC Internal

$R_4 / R_3 = 1 / 4$

R_1, R_2 : External Resistor

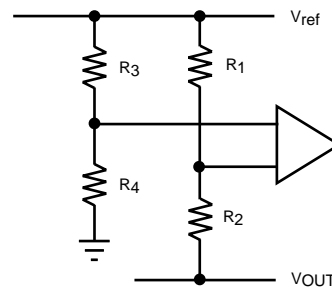

t_{ON} / t_{OFF}	$(V_{OUT} + V_F) / (V_{IN} - V_{SAT})$
I_{LPK}	$2 \times I_{LOAD} \times [(t_{ON} / t_{OFF}) + 1]$
f	$\frac{(V_{IN} - V_{SAT})^2 (V_{OUT} + V_F)}{2I_{LOAD} (V_{IN} - V_{SAT} + V_{OUT} + V_F)^2} \cdot \frac{1}{L}$
C_{OUT}	$(I_{LOAD} \times t_{ON}) / V_{RIPPLE}$

APPLICATION INFORMATION

COMPONENT REQUIREMENTS

Inductor

DC resistance of the inductor must be less than 5 Ω. For optimal performance and efficiency, an inductor with a DC resistance of less than 1 Ω is recommended. The oscillator frequency is inversely proportional to inductance. The inductance should be greater than 300 μH to prevent loss of efficiency at high frequencies.

There is a large peak current (up to $I_{LPK} = 300\text{mA}$) when the inductor is saturated.

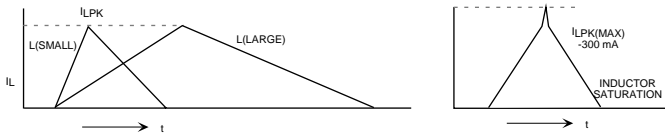

C_{FB} , C_{REF} , C_{IN} , C_{OUT}

The filtered output ripple is fed back to the feedback pin. To ensure continuous operation, C_{FB} should be connected between the feedback pin and ground. If a large voltage is fed back to the feedback pin, the power transistor switch drive will be intermittent. This causes a large ripple voltage since I_{LPK} becomes larger. The value of C_{FB} is determined by the value of the output capacitor, C_{OUT} , and the feedback resistance, R_2 . The feedback capacitor must be larger when the ripple voltage is high due to the lower C_{OUT} . C_{REF} is used to prevent oscillation of the band gap reference and to stabilize the feedback loop. The input capacitor, C_{IN} , is used to reduce supply impedance and to provide sufficient input current during switching for stable circuit operation.

Recommended values:

- $C_{REF} > 0.1 \mu\text{F}$
- $C_{FB} > 0.01 \mu\text{F}$
- $C_{IN} > 22 \mu\text{F}$
- $C_{OUT} > 22 \mu\text{F}$

Note: C_{OUT} should be sufficiently large and have a low ESR to minimize ripple voltage.

Control Pin Resistor (R_{CONT})

Input requirements of the Control pin are as follows:

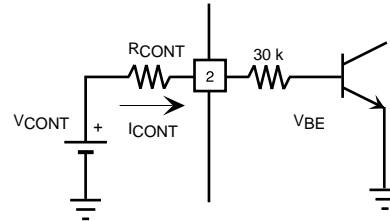

When V_{CONT} is high (above 2.2 V), the circuit operation is stopped. When V_{CONT} is low (below 0.4 V), operation is resumed.

A control current of 3 μA (typ.) is required for shutdown. Shutdown voltage, V_{CONT} , is related to the resistance R_{CONT} as shown below. V_{CONT} changes when R_{CONT} is changed.

$$V_{CONT} \sim R_{CONT} \times I_{CONT} + V_{BE}$$

$$V_{CONT} \sim (300 \text{ k}\Omega) \times (3 \mu\text{A}) + 0.7 \text{ V} = 1.60 \text{ V at } R_{SD} = 300 \text{ k}\Omega \text{ and } V_{BE} \sim 0.7 \text{ V}$$

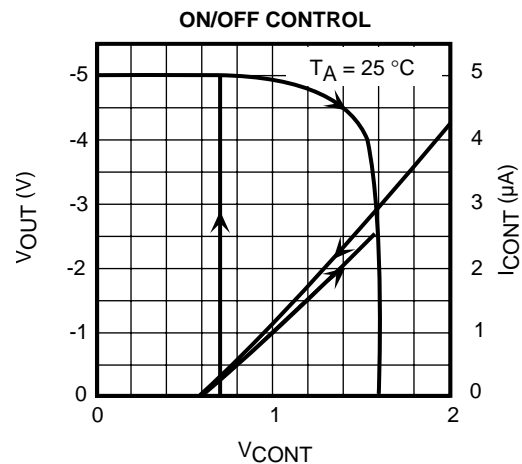

APPLICATION INFORMATION (CONT.)

INTERMITTENT OSCILLATION

When the ripple voltage applied to the feedback pin is large and C_{FB} is small, the power transistor switch drive is large and the output voltage exceeds the desired value. This causes the oscillator to stop for a period of t_i . When the ripple voltage is large and the power transistor is driven at maximum capacity, a current up to $I_{LPK(MAX)}$ goes through the inductor.

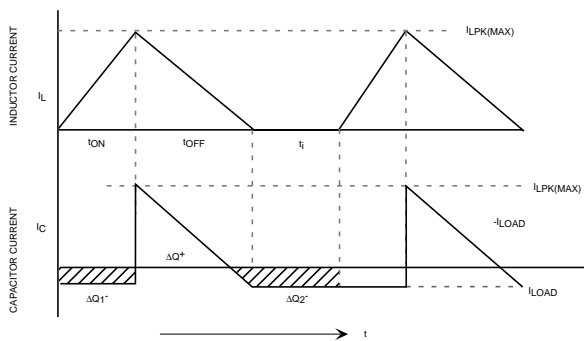

Note: $t_{ON}/t_{OFF} = (|V_{OUT}| + V_F) / (V_{IN} - V_{SAT})$
 $t_{ON} = [I_{LPK(MAX)} / (V_{IN} - V_{SAT})] \times L$
 $t_{OFF} = [I_{LPK(MAX)} / (|V_{OUT}| + V_F)] \times L$

Since the charge of the capacitor is equivalent to the discharge ($\Delta Q^+ = \Delta Q_1^- + \Delta Q_2^-$):

$$I_{LPK(MAX)} = 2 \times I_{LOAD} \times [(t_{ON} / t_{OFF}) + 1] + 2 \times I_{LOAD} \times (t_i / t_{OFF})$$

$$t_i = ([I_{LPK(MAX)} / (2 \times I_{LOAD})] \times t_{OFF}) - (t_{ON} + t_{OFF})$$

$$f = 1 / (t_{ON} + t_{OFF} + t_i)$$

When load current increases, t_i becomes shorter.

As in the case above, if the load current is too small, the power transistor becomes overdriven and intermittent oscillation will occur.

PACKAGE POWER DISSIPATION

The internal thermal protection circuit will operate when T_j is approximately 150 °C. When thermal protection operates, the power transistor switch will cycle between on and off to keep $T_j \leq 150$ °C. Thermal resistance Θ_{jA} is determined by

mounting. The package power dissipation curve on a printed circuit board is estimated as follows:

When Pin 4 is connected to GND (Power transistor switch is at maximum conductance), all input power is dissipated by the IC at $T_A =$ room temperature. In this state T_j goes up to 150 °C and thermal protection operates. Input power is defined as $P_{IN} = V_{IN} \times \langle I_{IN} \rangle$, where $\langle I_{IN} \rangle$ is the average of input current. From $T_j = \Theta_{jA} \times P + T_A$ and $T_j = 150$ °C. $P = P_{IN}$, $T_A =$ Room temp., Θ_{jA} can be found. The power dissipation curve shows the effect of mounting on thermal characteristics.

P_{LOSS} must be within this curve. The efficiency, E (%), is the ratio between input and output power when the dc-dc converter is operating.

$$P_{LOSS} = P_{IN} - P_{OUT}$$

$$= P_{OUT} \times [(100 / E) - 1]$$

$$= |V_{OUT}| \times I_{LOAD} \times [(100 / E) - 1]$$

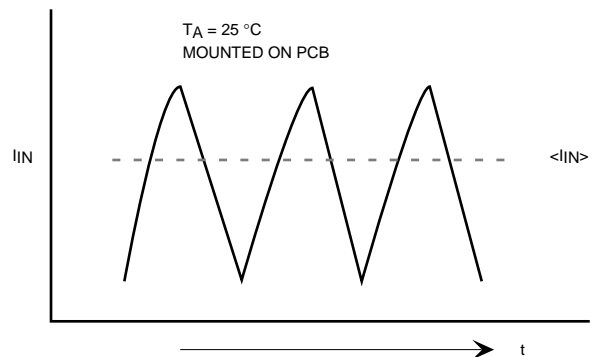
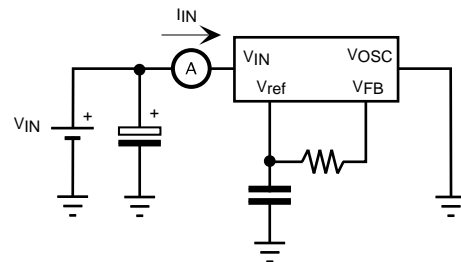

I_{IN} WAVEFORM WHEN THERMAL PROTECTION IS OPERATING

APPLICATION INFORMATION (CONT.)

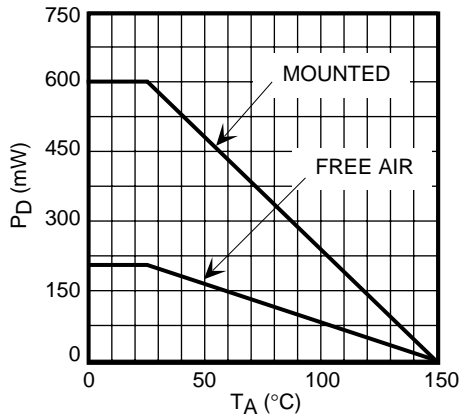
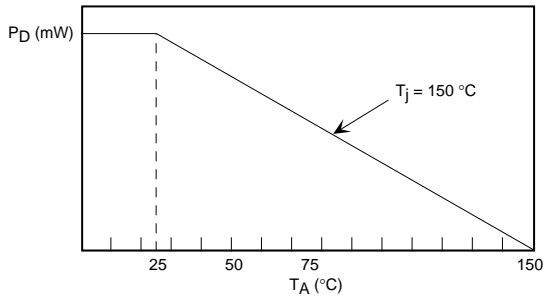

The components shown in the test circuit may be changed for different operating conditions (input/output voltage, output current, inductor type, etc.) The performance of the DC-DC converter depends largely on the coil in use. To optimize efficiency, a coil with a low DC resistance should be used, such as the Toko 646CY471M. Oscillation will begin with an inductor value as low as 100 μ H. However, if the Equivalent Series Resistance (ESR) is over 5 Ω , oscillation may not occur. The input and output capacitors should have a low ESR and high capacity since there is a large ripple current present. For operation below 0 $^{\circ}$ C, the capacitors should be selected for low ESR and good temperature stability at reduced temperatures. This is required to minimize ripple current. For low values of load current, a smaller coil can be used. For higher current, a large coil is needed to prevent saturation. When the coil saturates, the current increases dramatically, resulting in a severe overcurrent through the inductor. Please refer to the following drawings.

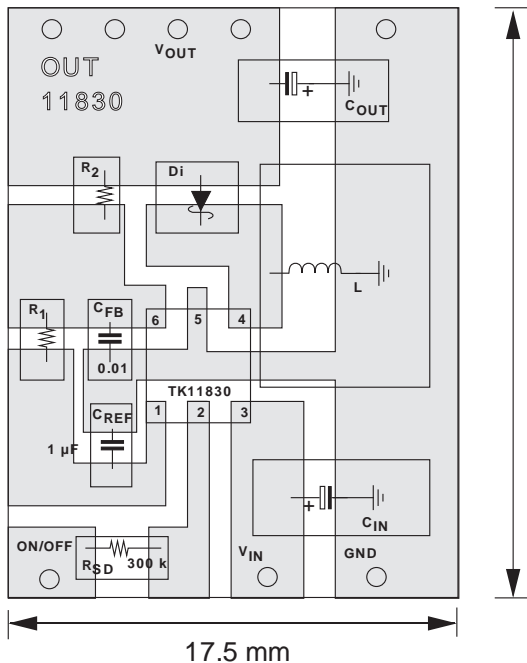

INDUCTOR CURRENT WAVEFORM (NORMAL)

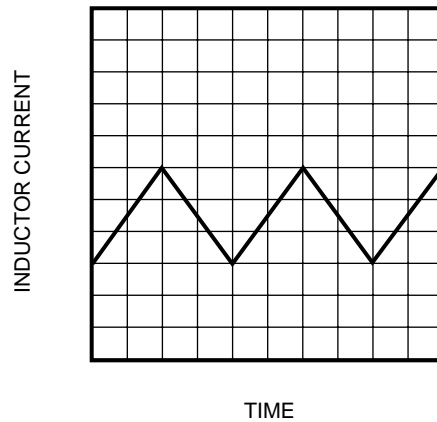

INDUCTOR CURRENT WAVEFORM (SATURATED INDUCTOR)

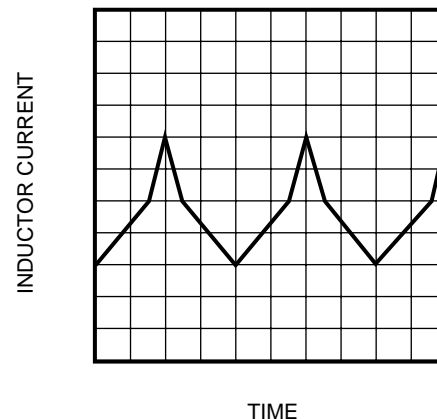

PACKAGE OUTLINE

SOT-23L (SOT-23L-6)

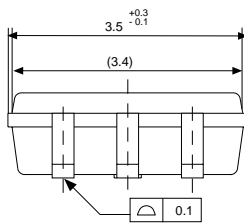
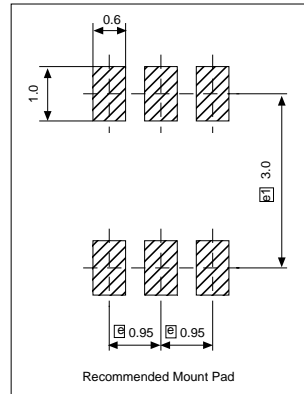
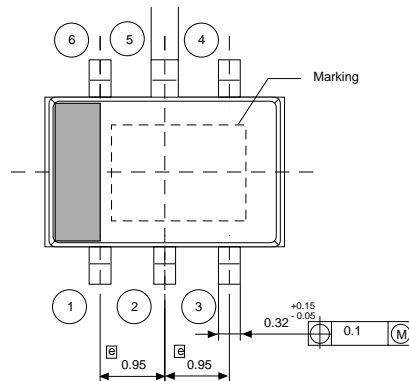

Dimensions are shown in millimeters
Tolerance: x.x = ± 0.2 mm (unless otherwise specified)

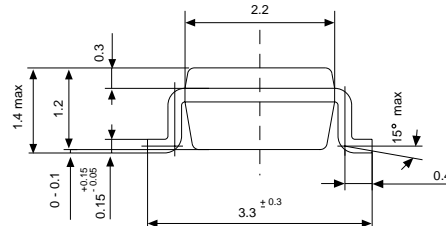

Marking Information

TK11830

Marking
N0

Toko America, Inc. Headquarters
1250 Feehanville Drive, Mount Prospect, Illinois 60056
Tel: (847) 297-0070 Fax: (847) 699-7864

TOKO AMERICA REGIONAL OFFICES

Midwest Regional Office
Toko America, Inc.
1250 Feehanville Drive
Mount Prospect, IL 60056
Tel: (847) 297-0070
Fax: (847) 699-7864

Western Regional Office
Toko America, Inc.
2480 North First Street, Suite 260
San Jose, CA 95131
Tel: (408) 432-8281
Fax: (408) 943-9790

Eastern Regional Office
Toko America, Inc.
107 Mill Plain Road
Danbury, CT 06811
Tel: (203) 748-6871
Fax: (203) 797-1223

Semiconductor Technical Support
Toko Design Center
4755 Forge Road
Colorado Springs, CO 80907
Tel: (719) 528-2200
Fax: (719) 528-2375

Visit our Internet site at <http://www.tokoam.com>

The information furnished by TOKO, Inc. is believed to be accurate and reliable. However, TOKO reserves the right to make changes or improvements in the design, specification or manufacture of its products without further notice. TOKO does not assume any liability arising from the application or use of any product or circuit described herein, nor for any infringements of patents or other rights of third parties which may result from the use of its products. No license is granted by implication or otherwise under any patent or patent rights of TOKO, Inc.