

27 - 31 GHz 2W Balanced Power Amplifier

TGA4513-CP



Key Features

- 27 - 31 GHz Bandwidth
- > 32 dBm Nominal P1dB
- 33 dBm Nominal Psat
- 22 dB Nominal Gain
- IMD3 is 32 dBc @ 18 dBm SCL
- 12 dB Nominal Return Loss
- Bias: 6 V, 840 mA
- Package Dimensions:
13.34 x 9.65 x 1.85 mm
(0.525 x 0.380 x 0.073 in)

Primary Applications

- Satellite Ground Terminal
- Point to Point Radio
- Point to Multi Point Radio
- LMDS

Product Description

The TriQuint TGA4513-CP is a compact 2 Watt High Power Amplifier Packaged MMIC for Ka-band applications. It provides 22 dB nominal gain and 12 dB nominal return loss.

The TGA4513 provides a nominal 33 dBm of output power. It is a lead free device.

The part is ideally suited for low cost emerging markets such as base station transmitters for satellite ground terminals, point to point radio and LMDS.

The TGA4513-CP is 100% RF tested to ensure performance compliance.

Lead-Free & RoHS compliant.

Evaluation boards are available.

Measured Data

Bias Conditions: Vd = 6 V, Id = 840 mA

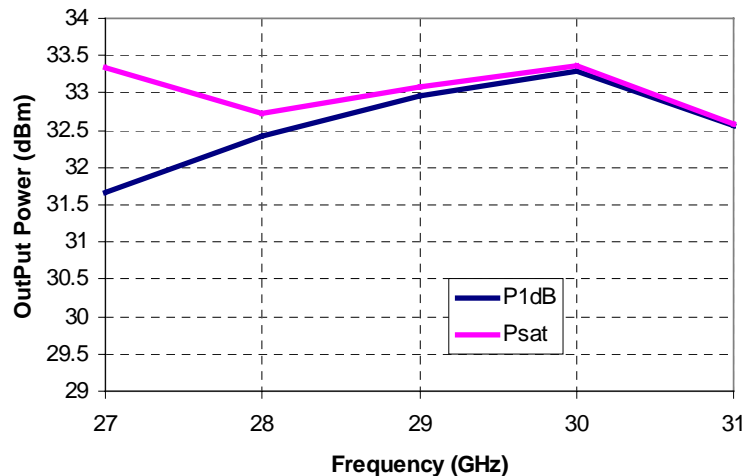
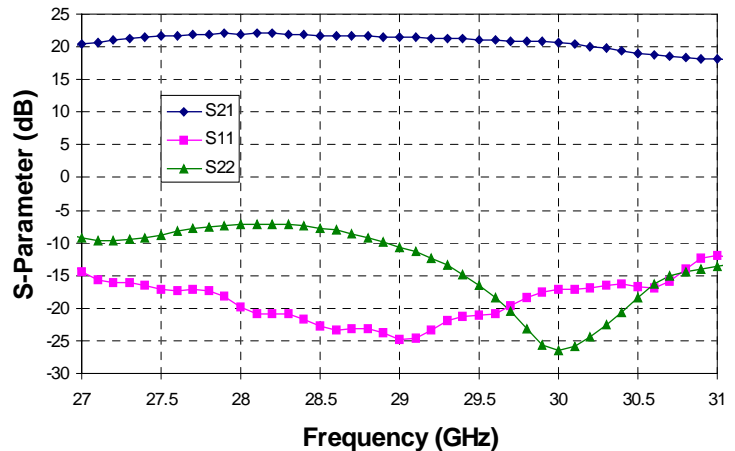

Note: This device is early in the characterization process prior to finalizing all electrical specifications. Specifications are subject to change without notice.

TABLE I
MAXIMUM RATINGS 1/

| SYMBOL | PARAMETER | VALUE | NOTES |
|------------------|-----------------------------------|---------------|--------------|
| V ⁺ | Positive Supply Voltage | 7 V | <u>2/</u> |
| V ⁻ | Negative Supply Voltage Range | -3 TO 0 V | |
| I ⁺ | Positive Supply Current | 1.05 A | <u>2/</u> |
| I _G | Gate Supply Current | 10 mA | <u>3/</u> |
| P _{IN} | Input Continuous Wave Power | 22 dBm | |
| P _D | Power Dissipation | 6.71 W | <u>2/ 4/</u> |
| T _{CH} | Operating Channel Temperature | 150 °C | <u>5/</u> |
| T _M | Mounting Temperature (30 Seconds) | 260 °C | |
| T _{STG} | Storage Temperature | -65 to 150 °C | |

- 1/ These ratings represent the maximum operable values for this device.
- 2/ Combinations of supply voltage, supply current, input power, and output power shall not exceed P_D.
- 3/ Total current for the device.
- 4/ When operated at this bias condition with a base plate temperature of 70 °C, the median life is 1.0E+6 hrs.
- 5/ Junction operating temperature will directly affect the device median time to failure (MTTF). For maximum life, it is recommended that junction temperatures be maintained at the lowest possible levels.

TABLE II
ELECTRICAL CHARACTERISTICS

(Ta = 25 °C, Nominal)

| PARAMETER | TYPICAL | UNITS |
|--|---------|-------|
| Drain Operating | 6 | V |
| Quiescent Current | 840 | mA |
| Small Signal Gain, S21 | 22 | dB |
| Input Return Loss, S11 | 14 | dB |
| Output Return Loss, S22 | 12 | dB |
| Output Power @ 1 dB Compression Gain, P1dB | > 32 | dBm |
| Power @ saturated, Psat | 33 | dBm |
| IMD3 @ 18 dBm SCL, at 30 GHz | 32 | dBc |

TABLE III
THERMAL INFORMATION

| Parameter | Test Conditions | T _{CH} (°C) | θ _{JC} (°C/W) | T _M (hrs) |
|---|--|----------------------|------------------------|----------------------|
| θ _{JC} Thermal Resistance (Channel to Backside of Package) | V _D = 6 V I _D = 0.84 A (Quiescent) P _{DISS} = 5.04 W Tbase = 70 °C | 130.1 | 11.92 | 5.9 E+6 |

Measured Data

Bias Conditions: $V_d = 6\text{ V}$, $I_d = 840\text{ mA}$

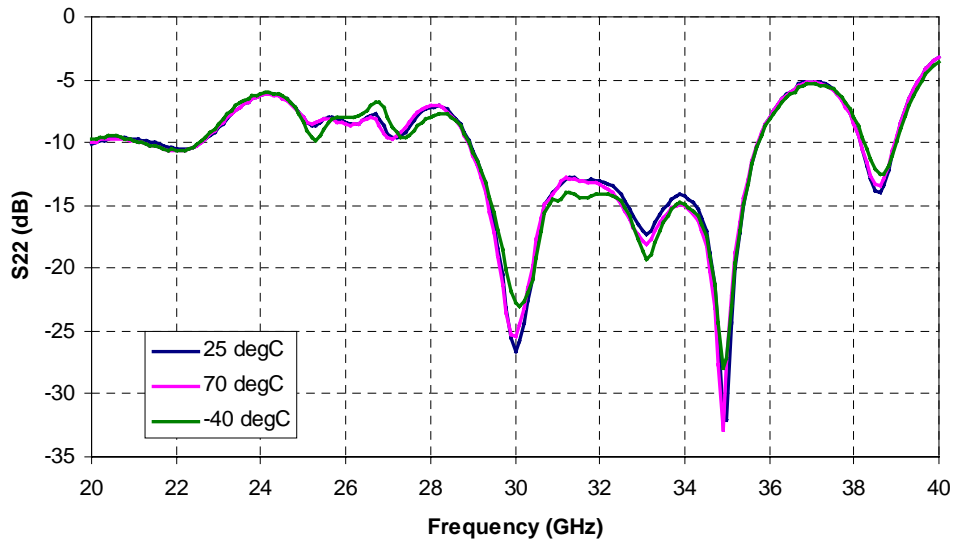
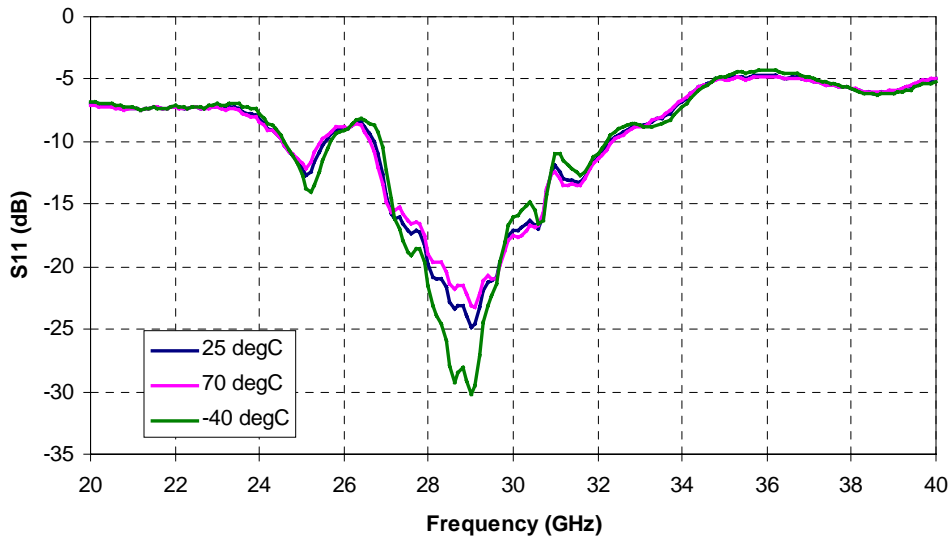
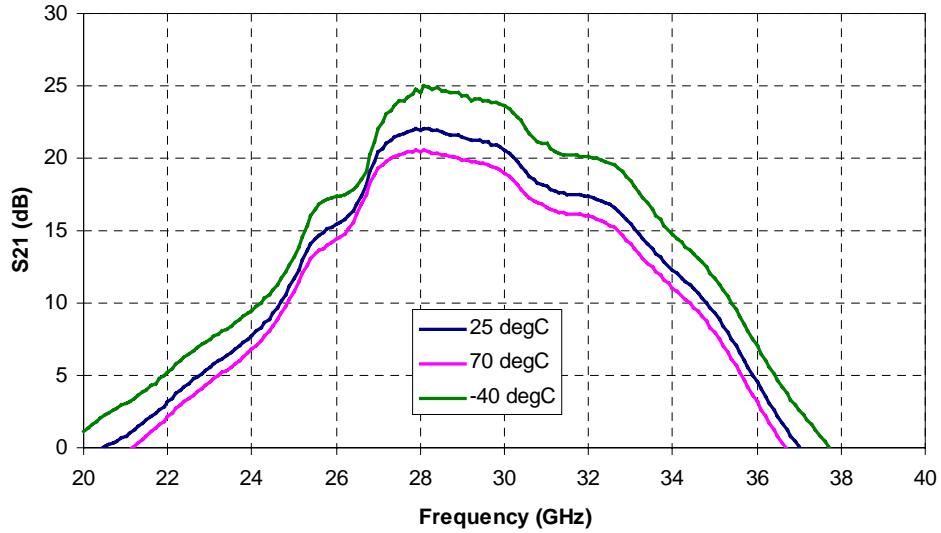

Measured Data

Bias Conditions: $V_d = 6\text{ V}$, $I_d = 840\text{ mA}$

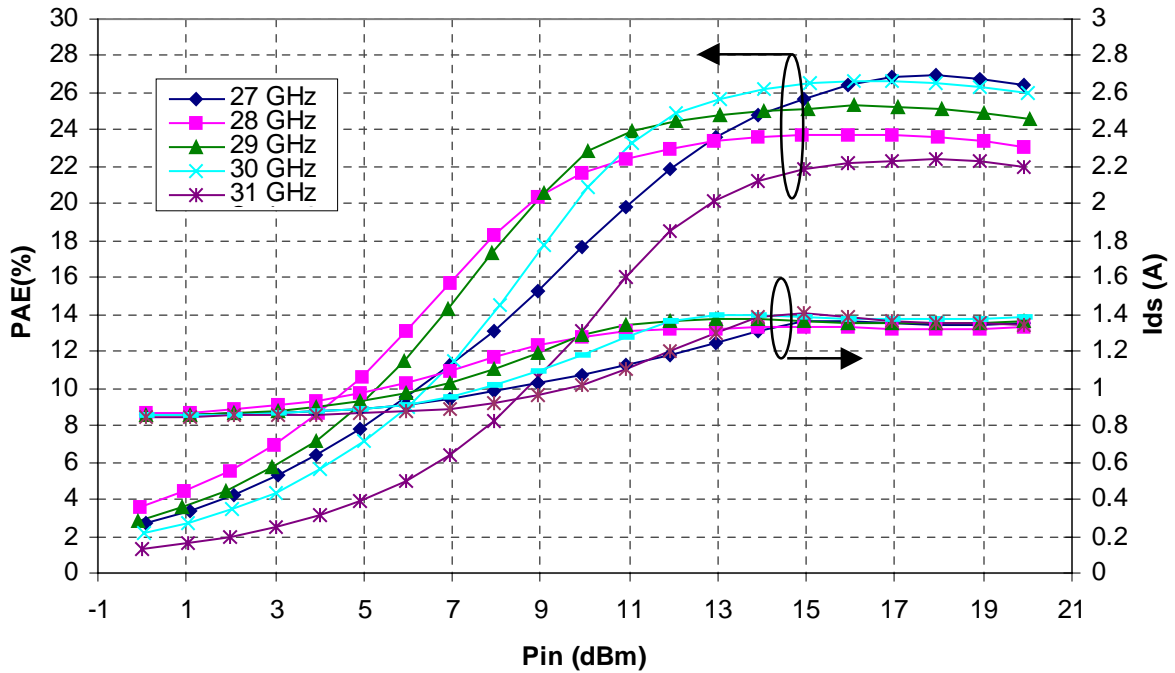
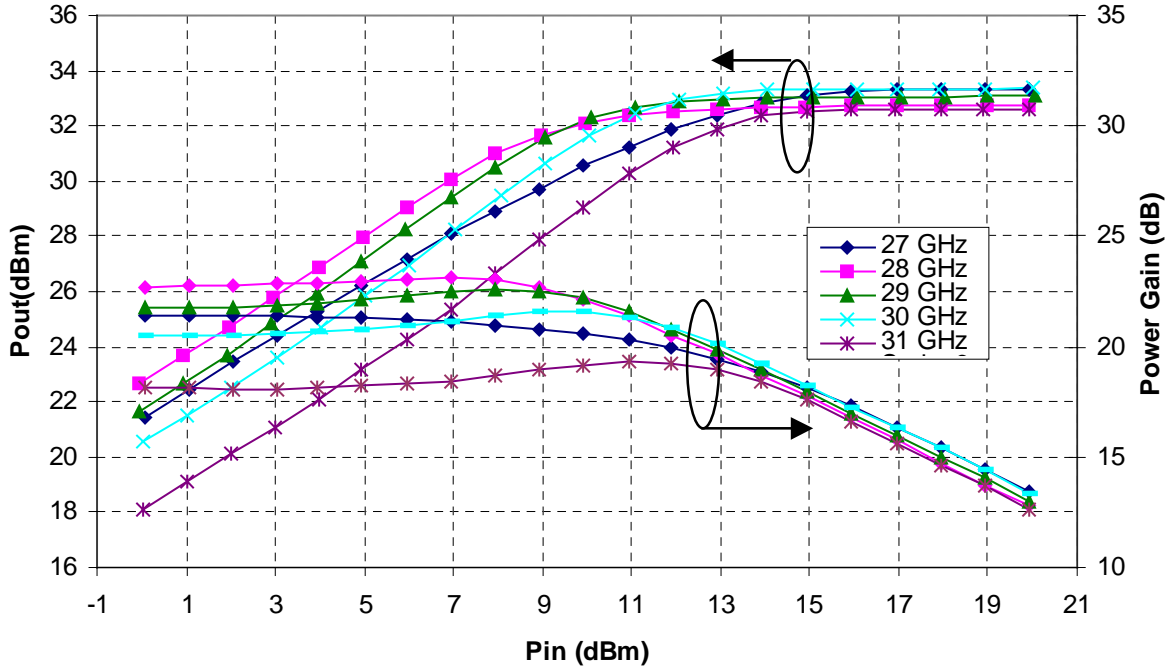

Measured Data

Bias Conditions: $V_d = 6\text{ V}$, $I_d = 840\text{ mA}$, $\Delta f = 10\text{ MHz}$

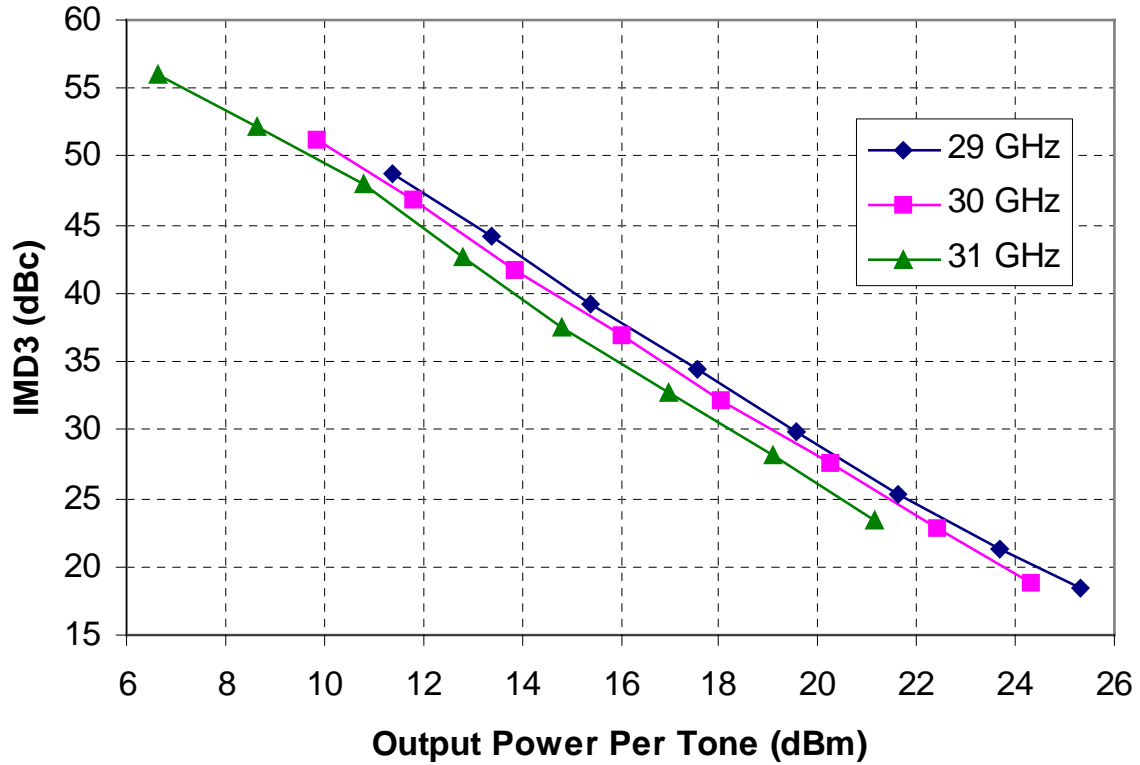

Package Pinout Diagram

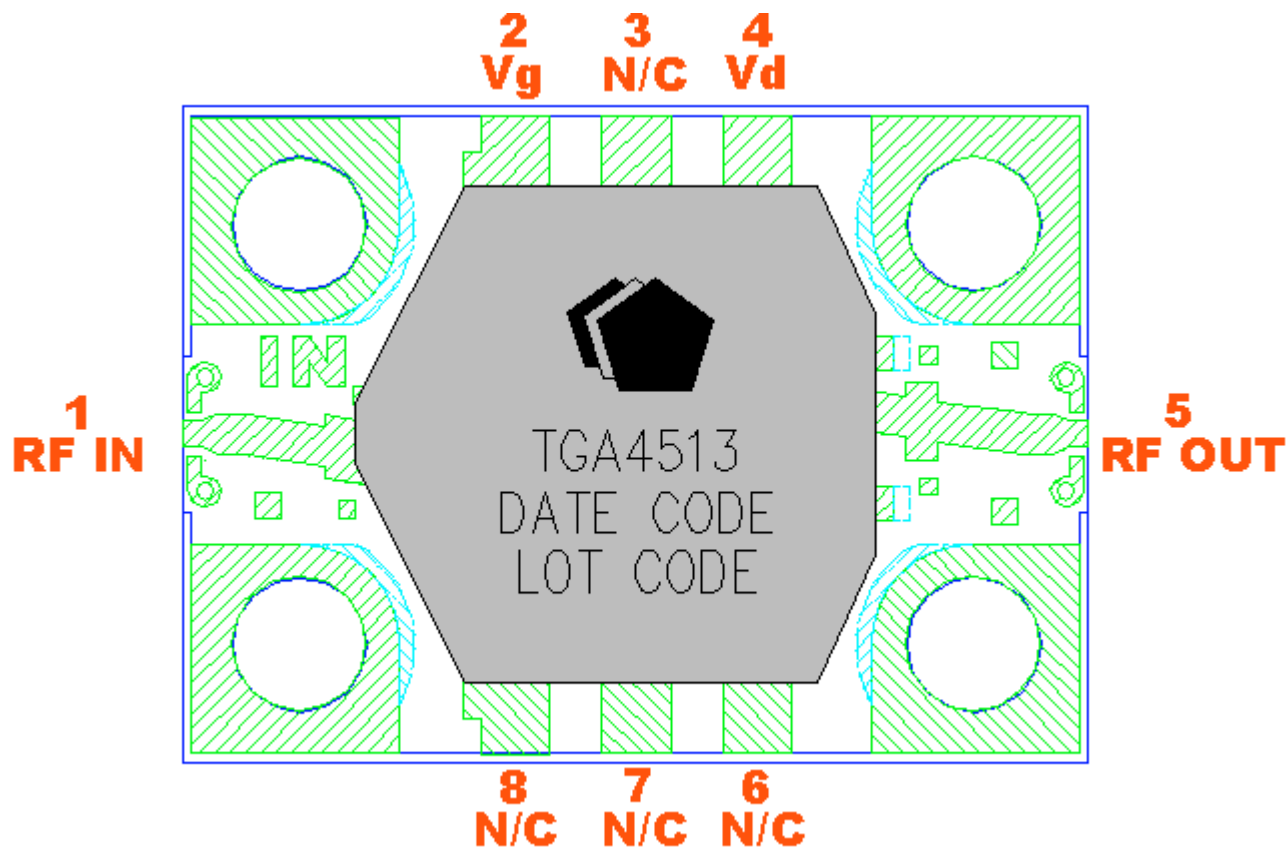

Mechanical Drawing

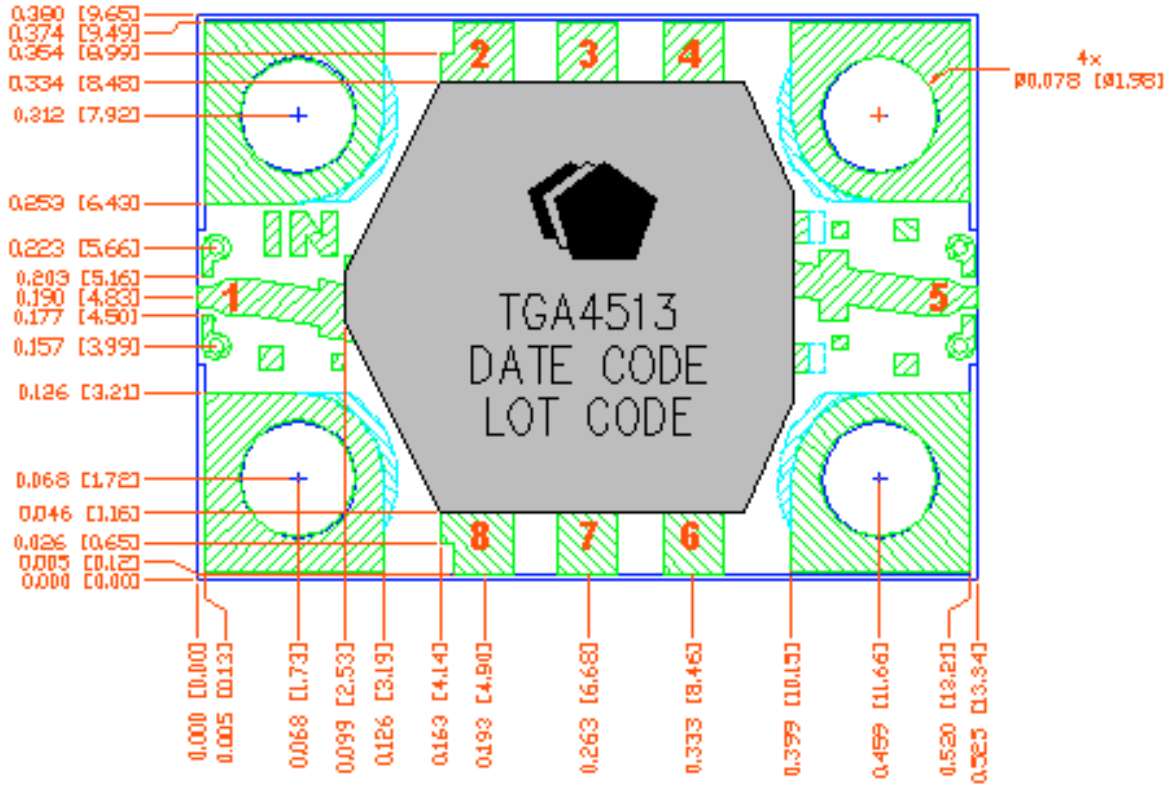

DIMENSIONS IN INCHES [MINIMETER]

Top View

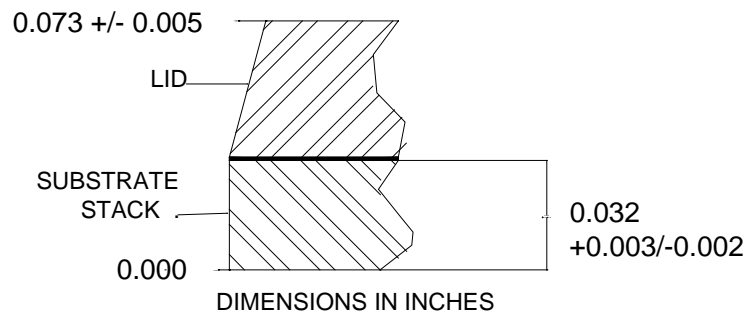

Side View

Bias Schematic

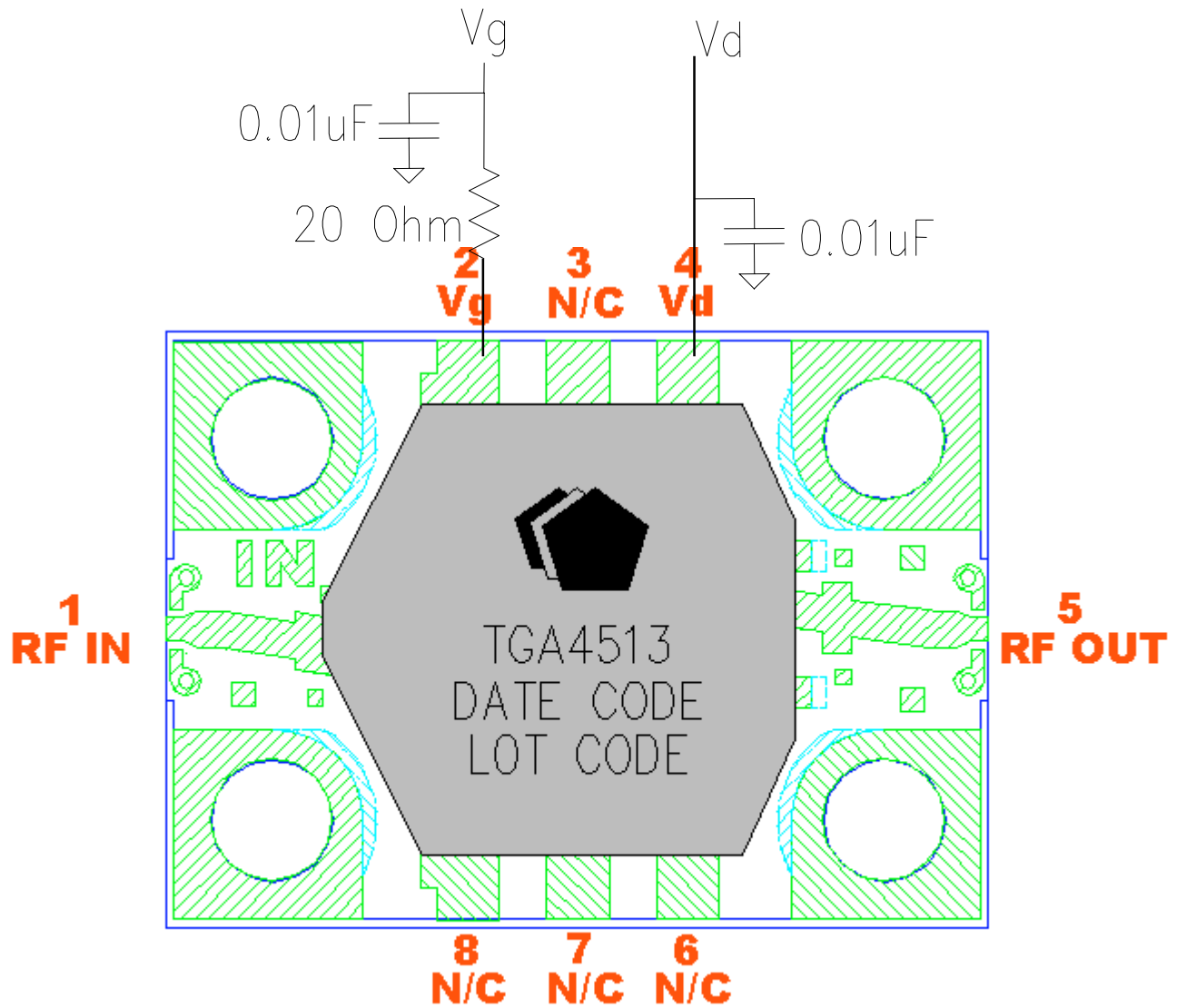

Tow 1 mil bond wires are recommended for the RF input, output and Vg. Four bond wires are recommended for Vd.

Assembly of a TGA4513-CP into a Module

Manual Assembly for Prototypes

1. Clean the module with Acetone. Rinse with alcohol and DI water. Allow the module to fully dry.
2. To improve the thermal and RF performance, we recommend attaching a heatsink to the bottom of the package. If the TGA4513-CP is mounted to the heatsink with mounting screws, we recommend an indium shim or other compliant material be inserted between the TGA4513-CP and the heatsink to reduce thermal contact resistance due to air gaps. The TGA4513-CP may also be attached to the heatsink using SN63 solder or any other Tin/Lead solder. The TGA4513-CP may also be mounted with DieMat DM6030HK conductive epoxy.
3. The DC and RF interconnects may be gold bondwires or gold ribbons. The RF interconnects should be as short as possible. A minimum of two 1 mil wires are recommended for the RF Input, RF Output, Vg, and four 1 mil bond wires for Vd.

ORDERING INFORMATION

| PART | PACKAGE STYLE |
|-------------|--------------------------|
| TGA4513-CP | CARRIER PLATE, LEAD FREE |