

DATA SHEET

TDA1591 PLL stereo decoder and noise blanker

Product specification
Supersedes data of March 1992
File under Integrated Circuits, IC01

1996 Sep 02

PLL stereo decoder and noise blanker

TDA1591

FEATURES

- Adjustment-free voltage controlled PLL oscillator for ceramic resonator ($f = 456$ kHz)
- Pilot signal dependent mono/stereo switching
- Analog control of mono/stereo change over [stereo blend, Stereo Noise Controller (SNC)]
- Adjacent channel noise suppression (114 kHz)
- Pilot canceller
- Analog control of de-emphasis; High Cut Control (HCC)
- Applicable as source selector for AM/FM/cassette switching
- Separate interference noise detector
- Integrated input low-pass filter for delayed noise blanking
- Noise blanking at MPX-demodulator outputs
- Internal voltage stabilization.

GENERAL DESCRIPTION

The TDA1591 is a monolithic bipolar integrated circuit providing the stereo decoder function and noise blanking for FM car radio applications.

The device operates in a power supply range of 7.5 to 12 V.

QUICK REFERENCE DATA

SYMBOL	PARAMETER	MIN.	TYP.	MAX.	UNIT
V_P	supply voltage (pin 5)	7.5	10	12	V
I_P	supply current	–	12	–	mA
$V_{o(rms)}$	audio output signal (RMS value)	–	900	–	mV
THD	total harmonic distortion	–	0.1	0.3	%
S/N	signal-to-noise ratio	–	76	–	dB
α_{CS}	channel separation	–	40	–	dB
V_{trigg}	interference voltage trigger level	–	10	–	mV

ORDERING INFORMATION

TYPE NUMBER	PACKAGE		
	NAME	DESCRIPTION	VERSION
TDA1591	DIP20	plastic dual in-line package; 20 leads (300 mil)	SOT146-1
TDA1591T	SO20	plastic small outline package; 20 leads; body width 7.5 mm	SOT163-1

PLL stereo decoder and noise blanker

TDA1591

BLOCK DIAGRAM

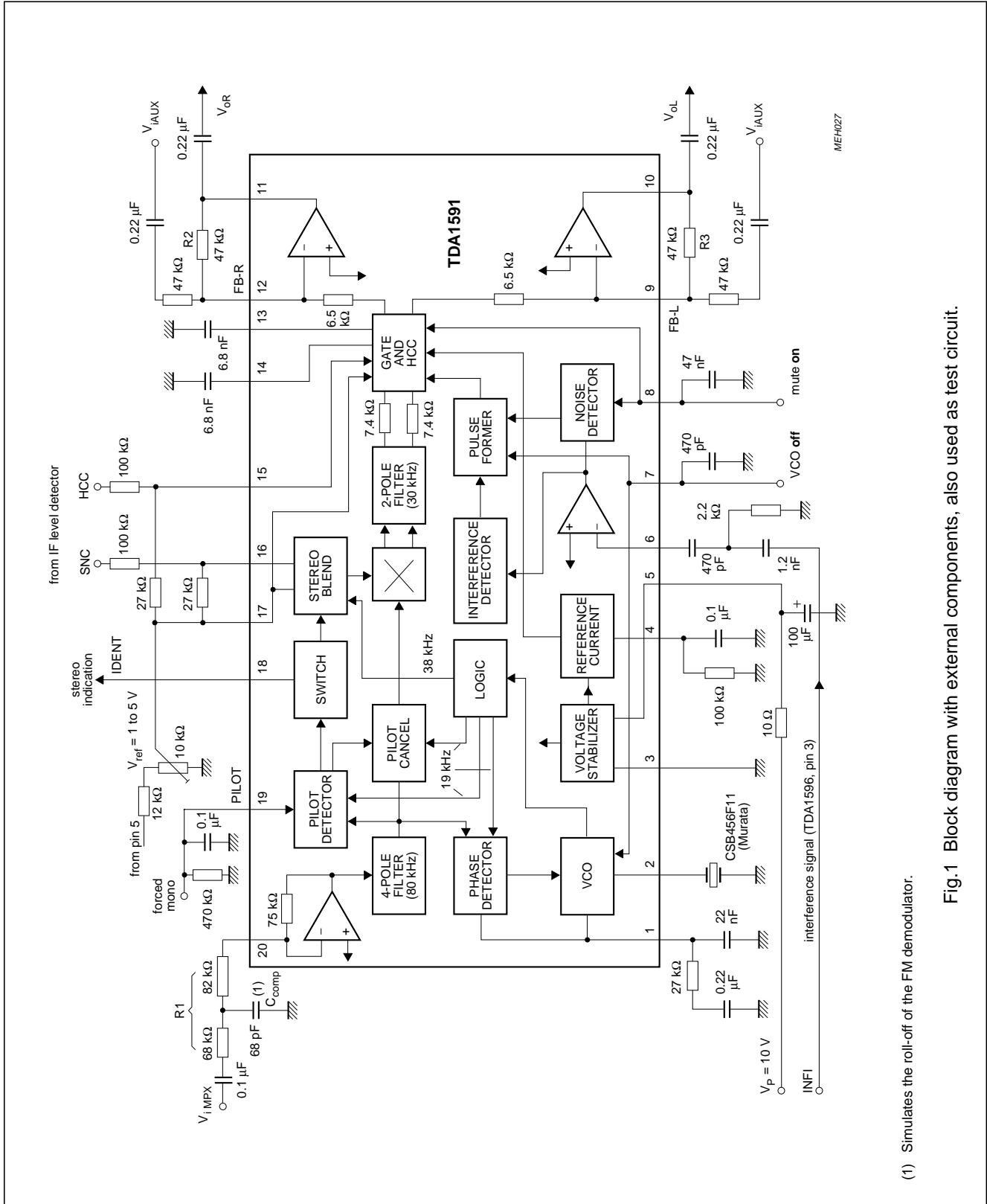

(1) Simulates the roll-off of the FM demodulator.

Fig.1 Block diagram with external components, also used as test circuit.

PLL stereo decoder and noise blanker

TDA1591

PINNING

SYMBOL	PIN	DESCRIPTION
PLL	1	phase locked loop filter
OSC	2	oscillator input/output pin for ceramic resonator
GND	3	ground (0 V)
I_{ref}	4	reference current
V_P	5	supply voltage (+10 V)
INFI	6	interference signal input
PUFO	7	pulse former time constant; VCO off
NDET	8	noise detector time constant; mute on
FB-L	9	AF feedback input for left audio signal
V_{oL}	10	AF output signal left
V_{oR}	11	AF output signal right
FB-R	12	AF feedback input for right audio signal
C_{DEEL}	13	de-emphasis capacitor for left channel
C_{DEER}	14	de-emphasis capacitor for right channel
HCC	15	HCC input for de-emphasis control
SNC	16	stereo blend input
V_{ref}	17	externally applied reference voltage of 1 to 5 V
IDENT	18	identification output (HIGH = pilot existing; stereo)
PILOT	19	pilot detector level (forced mono input)
V_{iMPX}	20	MPX input signal from IF demodulator

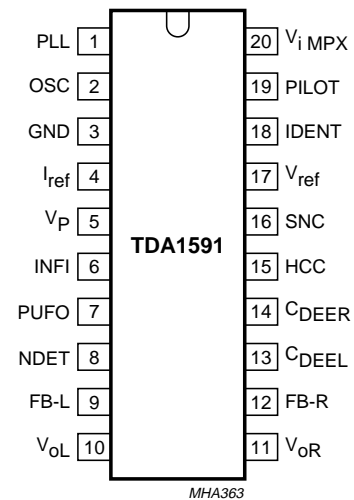

Fig.2 Pin configuration.

PLL stereo decoder and noise blanker

TDA1591

FUNCTIONAL DESCRIPTION

Adapting the MPX input to the level of the FM demodulator output is realized by the value of input resistor R1 (see Fig.3). The total gain of the stereo decoder is applicable by varying the feedback resistors R2 and R3 (see Figs 1 and 4).

In mute position and the VCO switched **off** (pin 7), the output amplifiers can be used for cassette playback, AM stereo purpose or other signal sources.

The Stereo Noise Controller (SNC) provides a smooth mono to stereo take-over (see Fig.5).

For High Cut Control (HCC), the de-emphasis time constant can be changed to higher values (see Figs 7 and 8). This function is controlled by an analog input signal.

The noise blanking facility is achieved by gating the stereo decoder output signal.

The interference detector generates a gating pulse preferable forced by the level detector voltage of the IF part.

LIMITING VALUES

In accordance with the Absolute Maximum Rating System (IEC 134).

SYMBOL	PARAMETER	MIN.	MAX.	UNIT
V _P	supply voltage (pin 5)	0	13.2	V
P _{tot}	total power dissipation	0	0.25	W
T _{stg}	storage temperature	-55	+150	°C
T _{amb}	operating ambient temperature	-40	+85	°C
V _{es}	electrostatic handling; note 1			
	pins 1 and 16	-400	+400	V
	pin 5	-300	+300	V
	all other pins	-600	+600	V

Note

- Equivalent to discharging a 200 pF capacitor through a 0 Ω series resistor.

PLL stereo decoder and noise blanker

TDA1591

CHARACTERISTICS

$V_P = 10\text{ V}$; $T_{\text{amb}} = 25\text{ }^\circ\text{C}$; input signal $V_{i\text{MPX}(p-p)} = 1.7\text{ V}$; $m = 100\%$ ($\Delta f = \pm 75\text{ kHz}$, $f_{\text{mod}} = 1\text{ kHz}$); de-emphasis of $50\text{ }\mu\text{s}$ and series resistor at input $R_1 = 150\text{ k}\Omega$; measurements taken in Fig.1; unless otherwise specified.

SYMBOL	PARAMETER	CONDITIONS	MIN.	TYP.	MAX.	UNIT
Supply						
V_P	supply voltage (pin 5)		7.5	10	12	V
I_P	supply current		–	12	–	mA
Stereo decoder						
$V_{i\text{MPX}(p-p)}$	MPX input signal on pin 20 (peak-to-peak value)		–	1.7	–	V
$\Delta V_{i\text{MPX}(p-p)}$	overdrive margin of MPX input signal	THD = 1%	3	–	–	dB
$V_{o(\text{rms})}$	AF mono output signal at pins 10 and 11 (RMS value)	without pilot	–	900	–	mV
ΔV_o	overdrive margin of output signal	THD = 1%	3	–	–	dB
V_{10-11}/V_o	difference of output voltage levels		–	–	1	dB
$V_{o\ 10,11}$	DC output voltage (pins 10 and 11)		3.3	3.8	4.3	V
$R_{o\ 10,11}$	output resistance		–	130	–	Ω
α_{cs}	channel separation	pin 16 open-circuit; see Fig.6	–	40	–	dB
THD	total harmonic distortion		–	0.1	0.3	%
S/N	signal-to-noise ratio	$f = 20\text{ to }16000\text{ Hz}$	–	76	–	dB
α_{19}	pilot signal suppression	$f = 19\text{ kHz}$	–	50	–	dB
α_{38}	subcarrier suppression	$f = 38\text{ kHz}$	–	50	–	dB
α_{57}		$f = 57\text{ kHz}$	–	46	–	dB
α_{76}		$f = 76\text{ kHz}$	–	60	–	dB
IM2	intermodulation for $f_{\text{spur}} = 1\text{ kHz}$	$f_{\text{mod}} = 10\text{ kHz}$; note 1	–	60	–	dB
IM3		$f_{\text{mod}} = 13\text{ kHz}$; note 1	–	58	–	dB
$\alpha_{57\text{ARI}}$	traffic radio (ARI)	$f = 57\text{ kHz}$; note 2	–	70	–	dB
α_{67}	Subsidiary Communication Authorization (SCA)	$f = 67\text{ kHz}$; note 3	70	–	–	dB
α_{114}	Adjacent Channel Interference (ACI)	$f = 114\text{ kHz}$; note 4	–	80	–	dB
α_{190}		$f = 190\text{ kHz}$; note 4	–	70	–	dB
PSRR	power supply ripple rejection	$f = 100\text{ Hz}$; $V_{\text{ripple}(\text{rms})} = 100\text{ mV}$	–	35	–	dB
VCO (pin 2)						
f_{osc}	oscillator frequency (ceramic resonator)		–	456	–	kHz
	frequency range of free running oscillator		452	–	460	kHz
$\Delta f/f$	capture and holding range		–	1	–	%
V_7	VCO-off voltage (pin 7)		0	–	0.6	V

PLL stereo decoder and noise blanker

TDA1591

SYMBOL	PARAMETER	CONDITIONS	MIN.	TYP.	MAX.	UNIT
Mono/stereo control (pins 16, 17 and 19)						
$V_{i\text{ pilot(rms)}}$	pilot threshold voltage for automatic switching by pilot input voltage (RMS value)	stereo on	–	24	30	mV
		stereo off	8	20	–	mV
HYS	hysteresis of pilot threshold voltage		–	2	–	dB
V_{19}	switching voltage for external mono control (pin 19)		0	–	1	V
V_{ref}	reference input voltage range (pin 17)		1	–	5	V
V_{16-17}	control voltage for channel separation due to pin 17 (V_{ref})	$\alpha_{\text{CS}} = 6\text{ dB}$; see Fig.5	–	–85	–	mV
		$\alpha_{\text{CS}} = 26\text{ dB}$; see Fig.5	–	–32	–	mV
Pilot indicator logic level output (pin 18)						
V_{18}	LOW voltage	$I_{18} = -200\ \mu\text{A}$	–	250	400	mV
I_{18}	HIGH current	$V_{18} = 10\text{ V}$	–	–	1	μA
Muting (pin 8)						
MUTE_{att}	mute attenuation (pin 8)	$V_8 < 0.4\text{ V}$	–	80	–	dB
		$V_8 > 4\text{ V}$	–	–	0.2	dB
$V_{\text{O(offset)}}$	DC offset voltage (pins 10 and 11)	after muting	–	–	± 400	mV
HCC (pin 15)						
CR_{deem}	control range of de-emphasis for European standard for USA standard	see Figs 7 and 8 $C_{\text{deem}} = 6.8\text{ nF}$	50	–	150	μs
		$C_{\text{deem}} = 10\text{ nF}$	75	–	225	μs
V_{15-17}	control voltage (pin 15 due to pin 17) in both standards	lower value CR_{deem}	–	0	–	mV
		upper value CR_{deem}	–	–300	–	mV
Noise interference detector						
V_{trigg}	trigger threshold (pin 6)	$f_{\text{int}} = 120\text{ kHz}$ $V_{8(\text{DC})} = 7.7\text{ V}$	–	10	–	mV
		$V_{8(\text{DC})} = 6.7\text{ V}$	–	100	–	mV
ΔV_8	voltage offset as a function of V_{trigg}	$V_{6\text{ trigg}} = 10\text{ mV}$	–	200	–	mV
		$V_{6\text{ trigg}} = 100\text{ mV}$	–	2.3	–	V
t_{sup}	AF suppression time; pulse width		–	40	–	μs
$I_{13,14}$	input offset current (pins 13 and 14)	during AF suppression time	–	20	–	nA
V_{pulse}	trigger sensitivity (pin 6)	$\tau_{\text{pulse}} = 10\ \mu\text{s}$	–	10	–	mV

PLL stereo decoder and noise blanker
TDA1591

Notes

1. Intermodulation suppression [Beat Frequency Components (BFC)]:

$$IM2 = \frac{V_{o(\text{signal})}(\text{at } 1 \text{ kHz})}{V_{o(\text{spurious})}(\text{at } 1 \text{ kHz})}; f_s = (2 \times 10 \text{ kHz}) - 19 \text{ kHz}$$

$$IM3 = \frac{V_{o(\text{signal})}(\text{at } 1 \text{ kHz})}{V_{o(\text{spurious})}(\text{at } 1 \text{ kHz})}; f_s = (3 \times 13 \text{ kHz}) - 38 \text{ kHz}$$

measured with 91% mono signal; $f_{\text{mod}} = 10 \text{ kHz}$ or 13 kHz ; 9% pilot signal.

2. ARI suppression:

$$\alpha_{57} \text{ARI} = \frac{V_{o(\text{signal})}(\text{at } 1 \text{ kHz})}{V_{o(\text{spurious})}(\text{at } 1 \text{ kHz} \pm 23 \text{ Hz})}$$

measured with 91% stereo signal; $f_{\text{mod}} = 1 \text{ kHz}$; 9% pilot signal; 5% ARI subcarrier ($f_s = 57 \text{ kHz}$; $f_{\text{mod}} = 23 \text{ Hz}$; AM $m = 0.6$).

3. Subsidiary Communication Authorization (SCA):

$$\alpha_{67} = \frac{V_{o(\text{signal})}(\text{at } 1 \text{ kHz})}{V_{o(\text{spurious})}(\text{at } 9 \text{ kHz})}; f_s = (2 \times 38 \text{ kHz}) - 67 \text{ kHz}$$

measured with 81% mono signal; $f_{\text{mod}} = 1 \text{ kHz}$; 9% pilot signal; 10% SCA subcarrier ($f_s = 67 \text{ kHz}$, unmodulated).

4. Adjacent Channel Interference (ACI):

$$\alpha_{114} = \frac{V_{o(\text{signal})}(\text{at } 1 \text{ kHz})}{V_{o(\text{spurious})}(\text{at } 4 \text{ kHz})}; f_s = 110 \text{ kHz} - (3 \times 38 \text{ kHz})$$

$$\alpha_{190} = \frac{V_{o(\text{signal})}(\text{at } 1 \text{ kHz})}{V_{o(\text{spurious})}(\text{at } 4 \text{ kHz})}; f_s = 186 \text{ kHz} - (5 \times 38 \text{ kHz})$$

measured with 90% mono signal; $f_{\text{mod}} = 1 \text{ kHz}$; 9% pilot signal; 1% spurious signal ($f_s = 110 \text{ kHz}$ or 186 kHz , unmodulated).

PLL stereo decoder and noise blanker

TDA1591

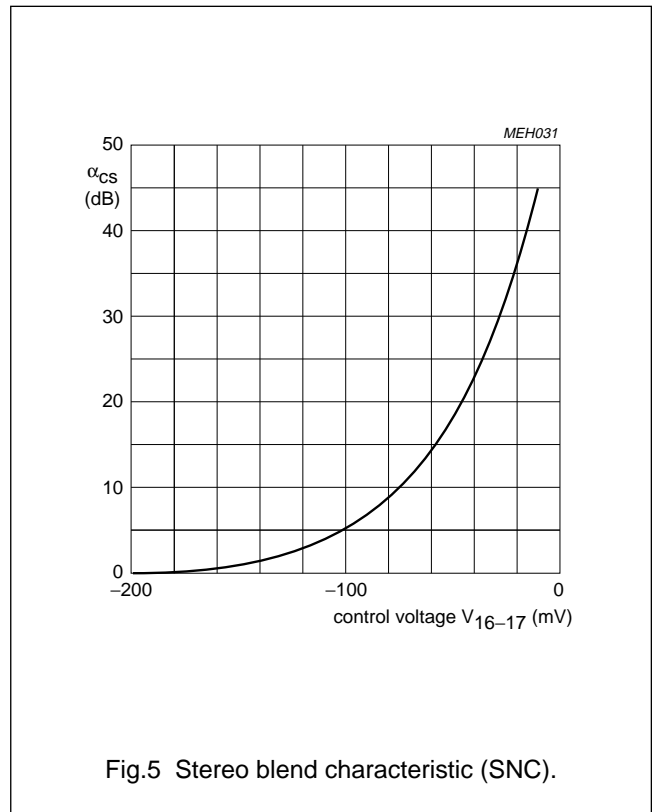
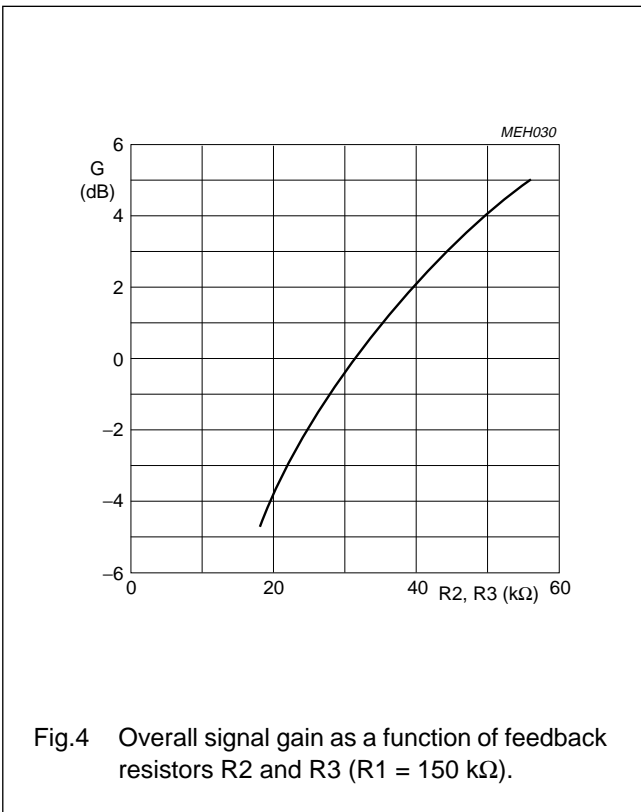
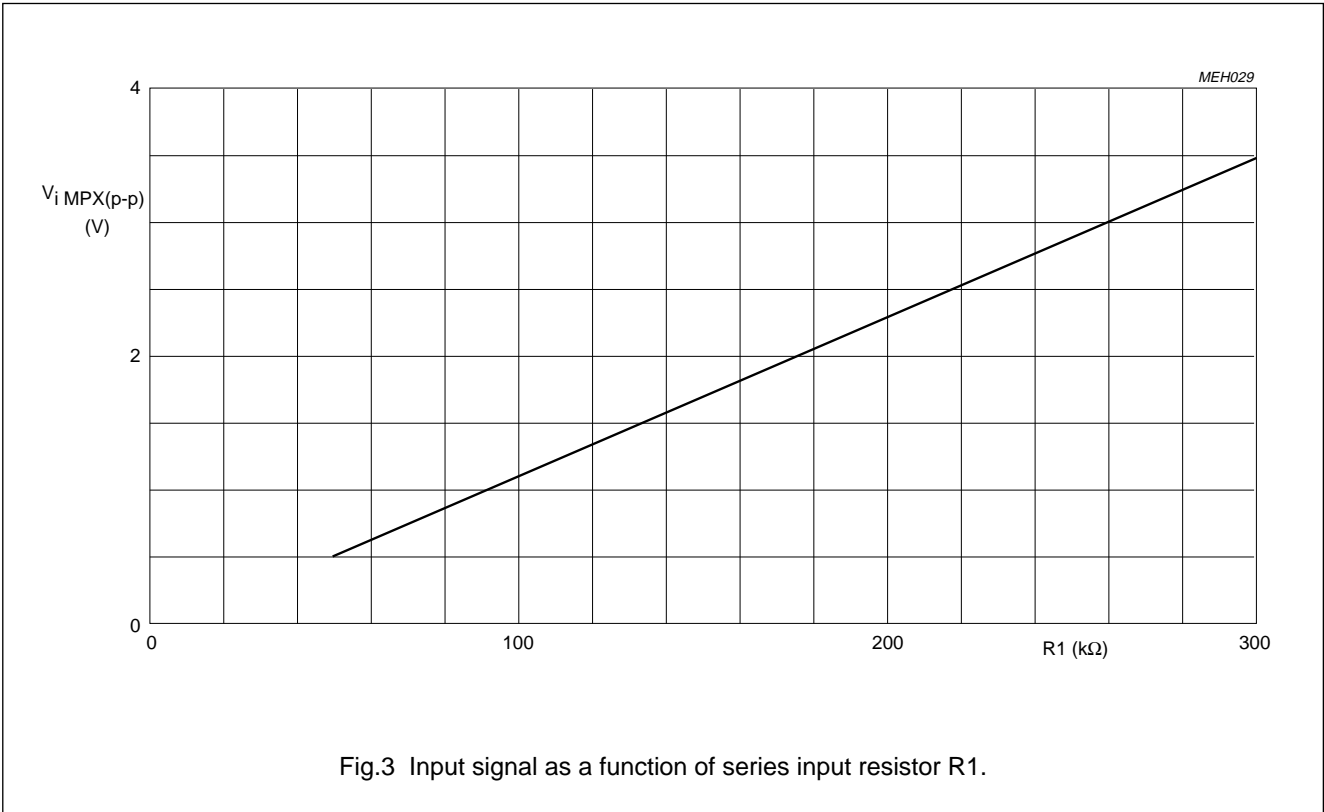

PLL stereo decoder and noise blanker

TDA1591

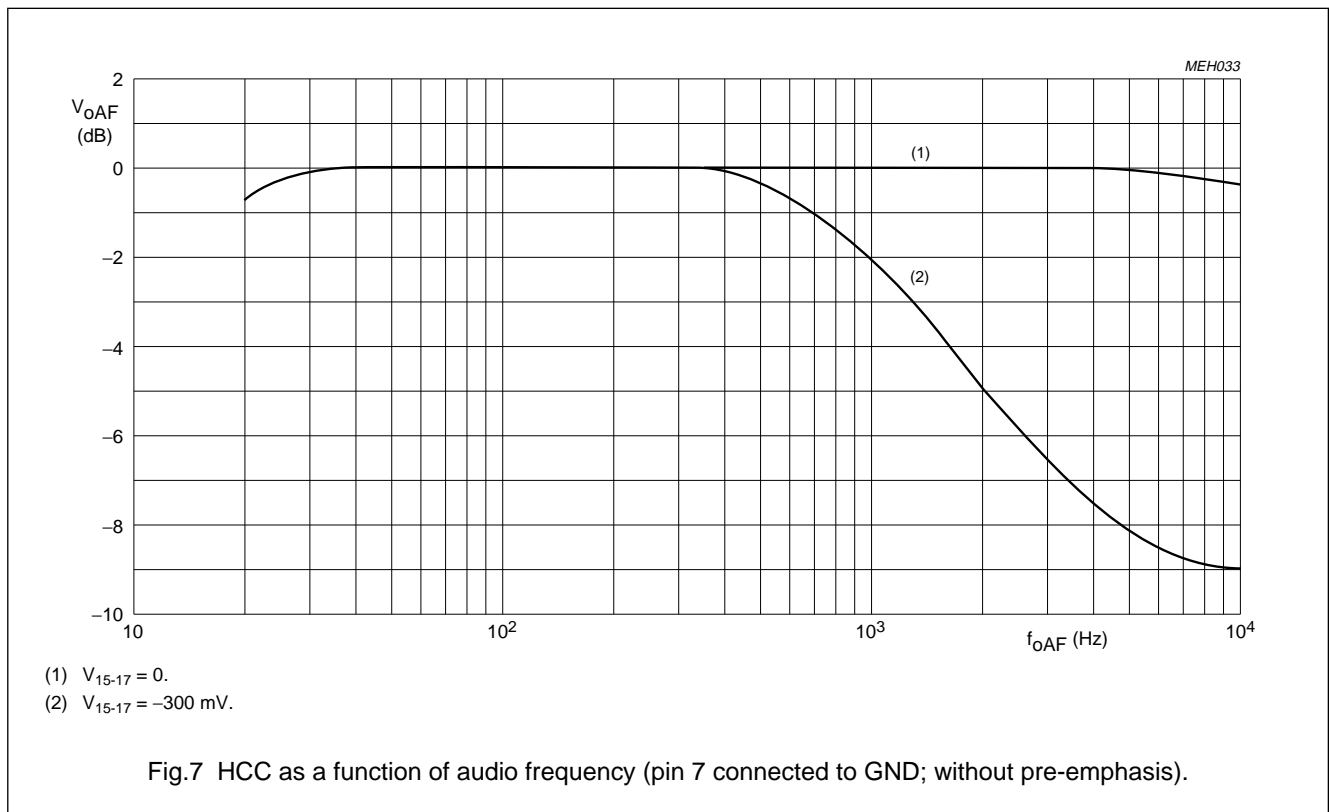
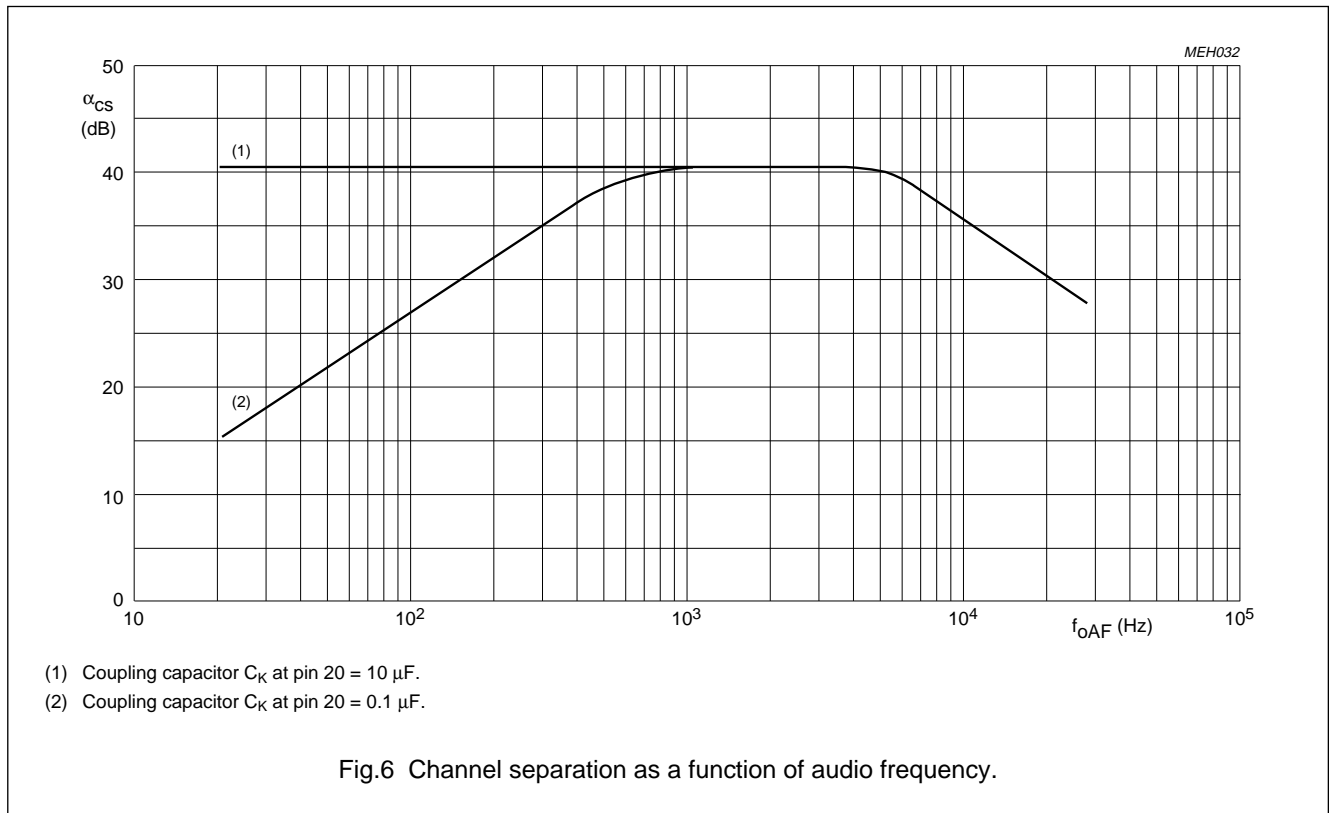

PLL stereo decoder and noise blanker

TDA1591

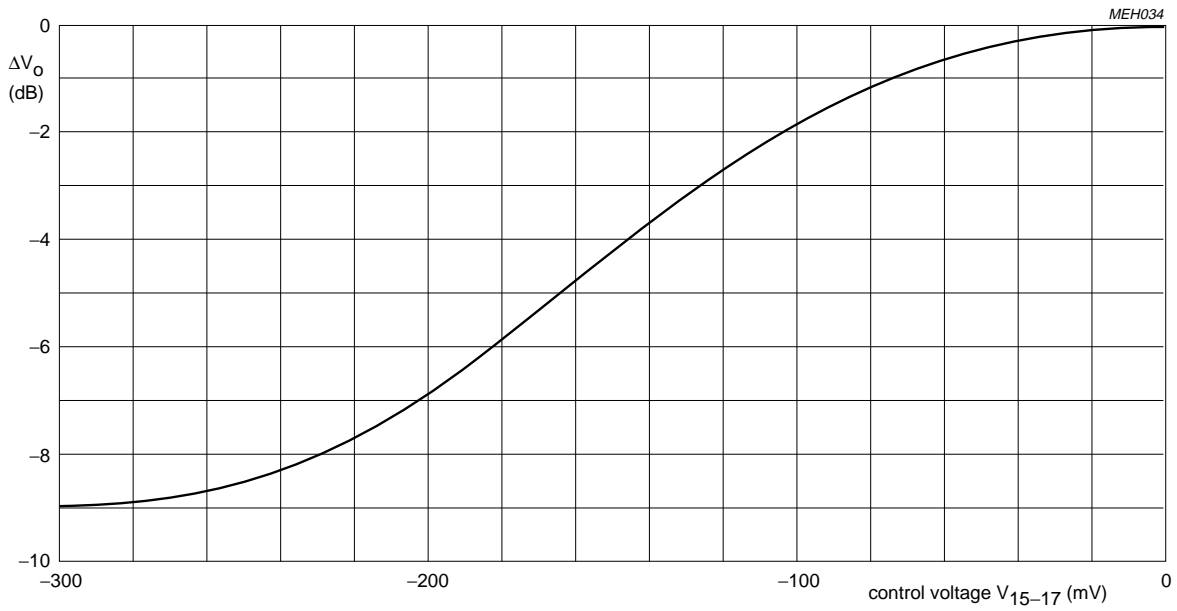
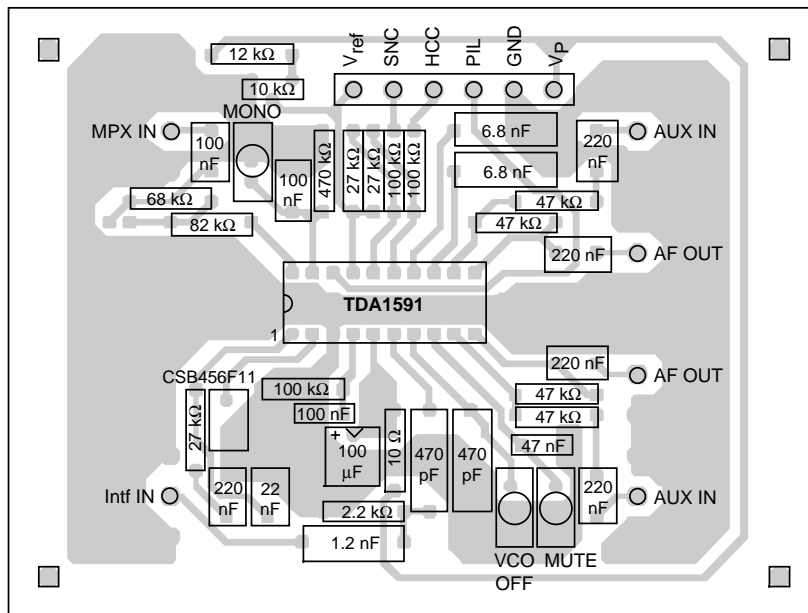
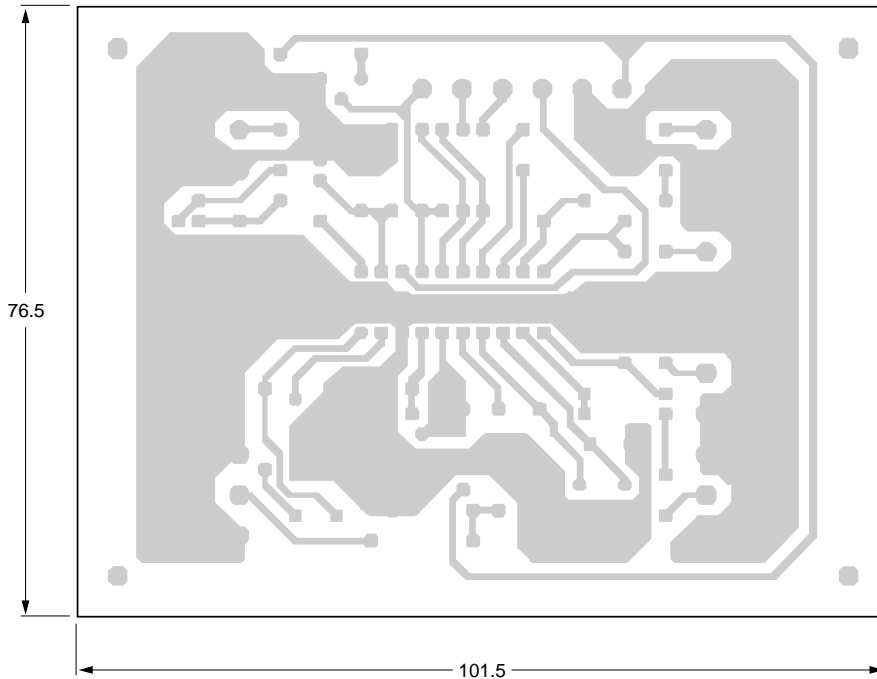

Fig.8 HCC with $f_{mod} = 10$ kHz.

PLL stereo decoder and noise blanker

TDA1591

TEST INFORMATION



MHA364

Dimensions in mm.

Fig.9 TDA1591 test board (component side).

PLL stereo decoder and noise blanker

TDA1591

PACKAGE OUTLINES

DIP20: plastic dual in-line package; 20 leads (300 mil)

SOT146-1

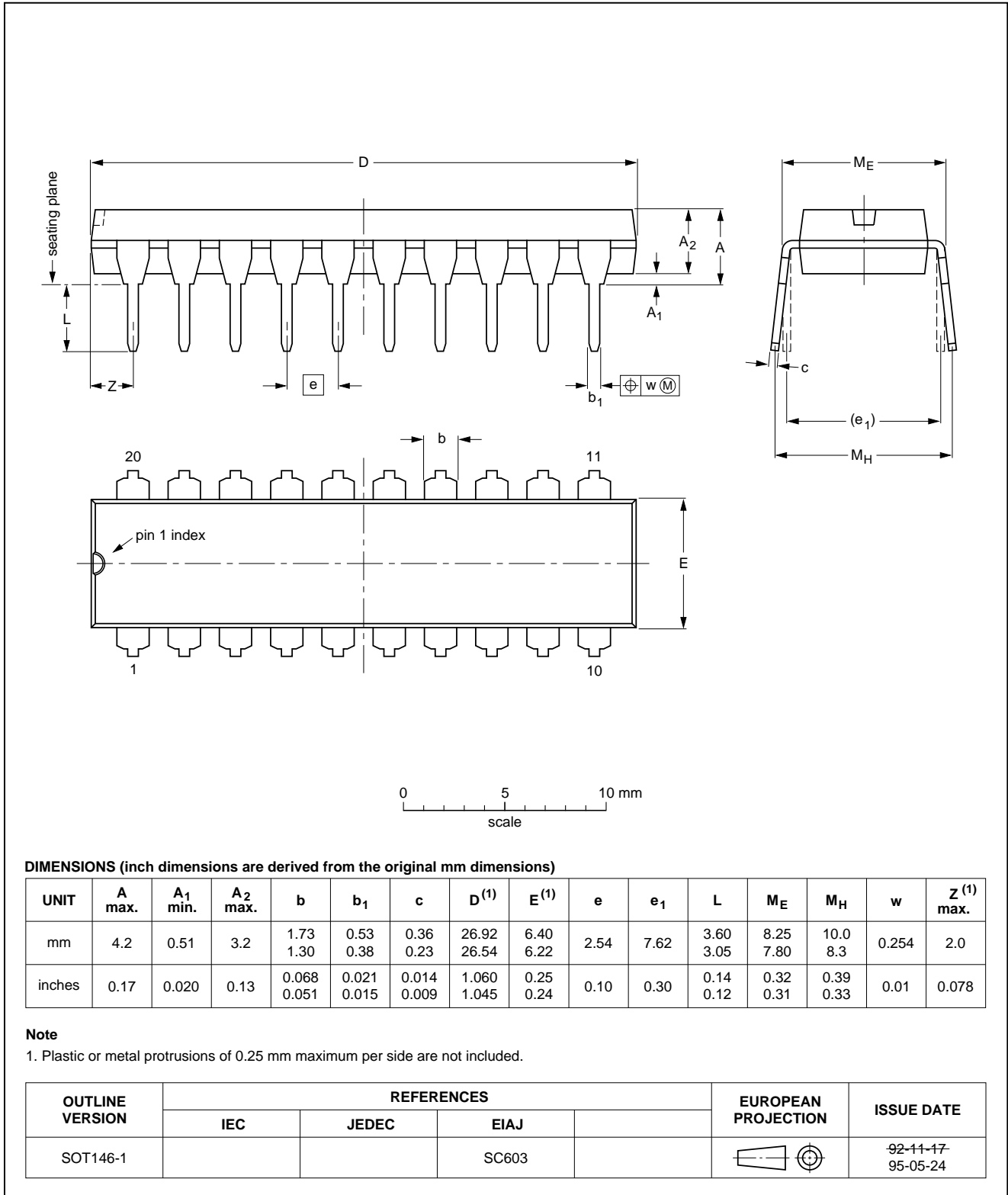

PLL stereo decoder and noise blanker

TDA1591

SO20: plastic small outline package; 20 leads; body width 7.5 mm

SOT163-1

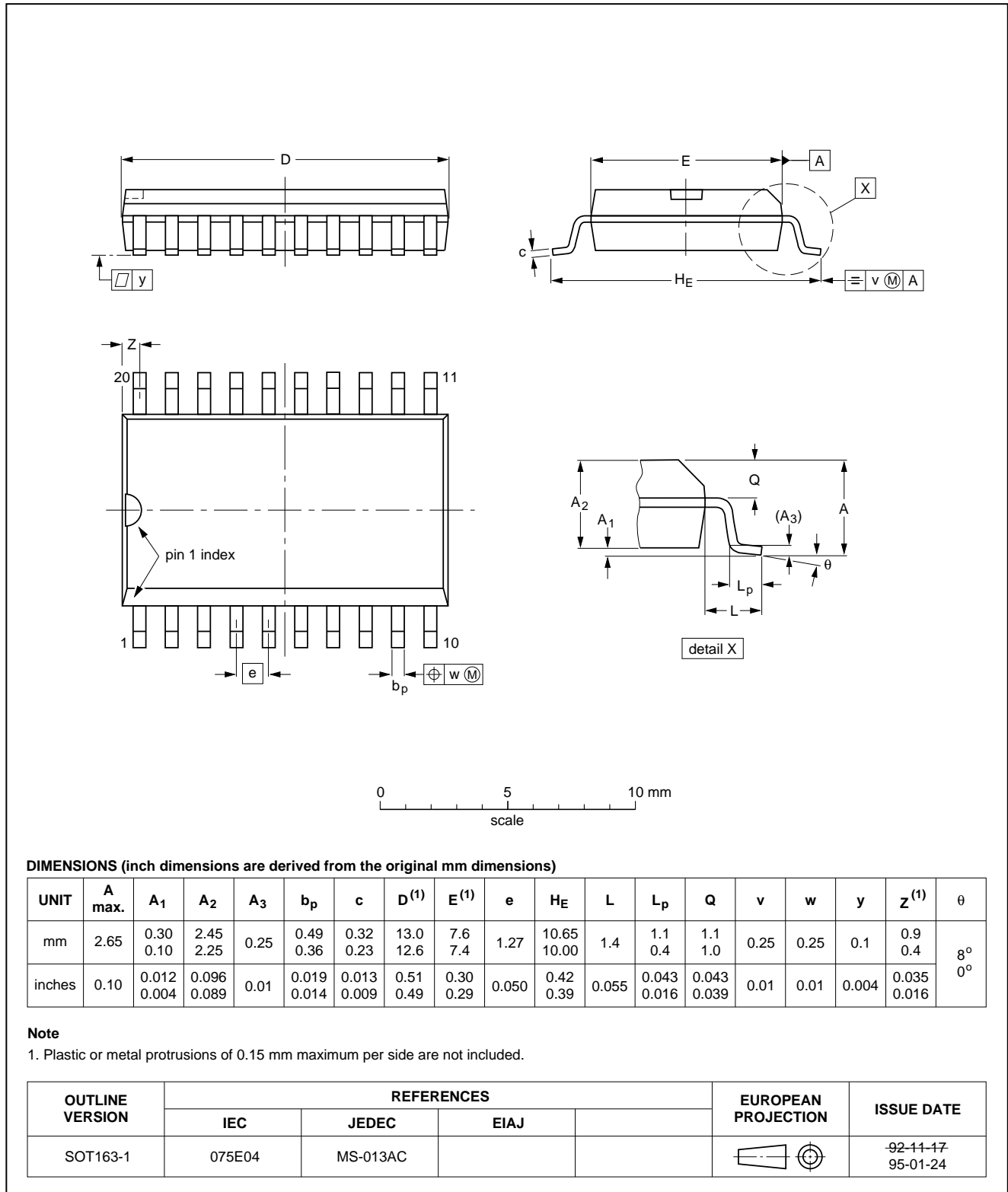

PLL stereo decoder and noise blanker

TDA1591

SOLDERING

Introduction

There is no soldering method that is ideal for all IC packages. Wave soldering is often preferred when through-hole and surface mounted components are mixed on one printed-circuit board. However, wave soldering is not always suitable for surface mounted ICs, or for printed-circuits with high population densities. In these situations reflow soldering is often used.

This text gives a very brief insight to a complex technology. A more in-depth account of soldering ICs can be found in our "IC Package Databook" (order code 9398 652 90011).

DIP

SOLDERING BY DIPPING OR BY WAVE

The maximum permissible temperature of the solder is 260 °C; solder at this temperature must not be in contact with the joint for more than 5 seconds. The total contact time of successive solder waves must not exceed 5 seconds.

The device may be mounted up to the seating plane, but the temperature of the plastic body must not exceed the specified maximum storage temperature ($T_{stg\ max}$). If the printed-circuit board has been pre-heated, forced cooling may be necessary immediately after soldering to keep the temperature within the permissible limit.

REPAIRING SOLDERED JOINTS

Apply a low voltage soldering iron (less than 24 V) to the lead(s) of the package, below the seating plane or not more than 2 mm above it. If the temperature of the soldering iron bit is less than 300 °C it may remain in contact for up to 10 seconds. If the bit temperature is between 300 and 400 °C, contact may be up to 5 seconds.

SO

REFLOW SOLDERING

Reflow soldering techniques are suitable for all SO packages.

Reflow soldering requires solder paste (a suspension of fine solder particles, flux and binding agent) to be applied to the printed-circuit board by screen printing, stencilling or pressure-syringe dispensing before package placement.

Several techniques exist for reflowing; for example, thermal conduction by heated belt. Dwell times vary between 50 and 300 seconds depending on heating method. Typical reflow temperatures range from 215 to 250 °C.

Preheating is necessary to dry the paste and evaporate the binding agent. Preheating duration: 45 minutes at 45 °C.

WAVE SOLDERING

Wave soldering techniques can be used for all SO packages if the following conditions are observed:

- A double-wave (a turbulent wave with high upward pressure followed by a smooth laminar wave) soldering technique should be used.
- The longitudinal axis of the package footprint must be parallel to the solder flow.
- The package footprint must incorporate solder thieves at the downstream end.

During placement and before soldering, the package must be fixed with a droplet of adhesive. The adhesive can be applied by screen printing, pin transfer or syringe dispensing. The package can be soldered after the adhesive is cured.

Maximum permissible solder temperature is 260 °C, and maximum duration of package immersion in solder is 10 seconds, if cooled to less than 150 °C within 6 seconds. Typical dwell time is 4 seconds at 250 °C.

A mildly-activated flux will eliminate the need for removal of corrosive residues in most applications.

REPAIRING SOLDERED JOINTS

Fix the component by first soldering two diagonally-opposite end leads. Use only a low voltage soldering iron (less than 24 V) applied to the flat part of the lead. Contact time must be limited to 10 seconds at up to 300 °C. When using a dedicated tool, all other leads can be soldered in one operation within 2 to 5 seconds between 270 and 320 °C.

PLL stereo decoder and noise blanker

TDA1591

DEFINITIONS

Data sheet status	
Objective specification	This data sheet contains target or goal specifications for product development.
Preliminary specification	This data sheet contains preliminary data; supplementary data may be published later.
Product specification	This data sheet contains final product specifications.
Limiting values	
Limiting values given are in accordance with the Absolute Maximum Rating System (IEC 134). Stress above one or more of the limiting values may cause permanent damage to the device. These are stress ratings only and operation of the device at these or at any other conditions above those given in the Characteristics sections of the specification is not implied. Exposure to limiting values for extended periods may affect device reliability.	
Application information	
Where application information is given, it is advisory and does not form part of the specification.	

LIFE SUPPORT APPLICATIONS

These products are not designed for use in life support appliances, devices, or systems where malfunction of these products can reasonably be expected to result in personal injury. Philips customers using or selling these products for use in such applications do so at their own risk and agree to fully indemnify Philips for any damages resulting from such improper use or sale.

PLL stereo decoder and noise blanker

TDA1591

NOTES

PLL stereo decoder and noise blanker

TDA1591

NOTES

PLL stereo decoder and noise blanker

TDA1591

NOTES

Philips Semiconductors – a worldwide company

Argentina: see South America

Australia: 34 Waterloo Road, NORTH RYDE, NSW 2113,
Tel. +61 2 9805 4455, Fax. +61 2 9805 4466

Austria: Computerstr. 6, A-1101 WIEN, P.O. Box 213,
Tel. +43 1 60 101, Fax. +43 1 60 101 1210

Belarus: Hotel Minsk Business Center, Bld. 3, r. 1211, Volodarski Str. 6,
220050 MINSK, Tel. +375 172 200 733, Fax. +375 172 200 773

Belgium: see The Netherlands

Brazil: see South America

Bulgaria: Philips Bulgaria Ltd., Energoproject, 15th floor,
51 James Bourchier Blvd., 1407 SOFIA,
Tel. +359 2 689 211, Fax. +359 2 689 102

Canada: PHILIPS SEMICONDUCTORS/COMPONENTS,
Tel. +1 800 234 7381

China/Hong Kong: 501 Hong Kong Industrial Technology Centre,
72 Tat Chee Avenue, Kowloon Tong, HONG KONG,
Tel. +852 2319 7888, Fax. +852 2319 7700

Colombia: see South America

Czech Republic: see Austria

Denmark: Prags Boulevard 80, PB 1919, DK-2300 COPENHAGEN S,
Tel. +45 32 88 2636, Fax. +45 31 57 1949

Finland: Sinikalliontie 3, FIN-02630 ESPOO,
Tel. +358 615 800, Fax. +358 615 80920

France: 4 Rue du Port-aux-Vins, BP317, 92156 SURESNES Cedex,
Tel. +33 1 40 99 6161, Fax. +33 1 40 99 6427

Germany: Hammerbrookstraße 69, D-20097 HAMBURG,
Tel. +49 40 23 53 60, Fax. +49 40 23 536 300

Greece: No. 15, 25th March Street, GR 17778 TAVROS,
Tel. +30 1 4894 339/911, Fax. +30 1 4814 240

Hungary: see Austria

India: Philips INDIA Ltd, Shivsagar Estate, A Block, Dr. Annie Besant Rd.
Worli, MUMBAI 400 018, Tel. +91 22 4938 541, Fax. +91 22 4938 722

Indonesia: see Singapore

Ireland: Newstead, Clonskeagh, DUBLIN 14,
Tel. +353 1 7640 000, Fax. +353 1 7640 200

Israel: RAPAC Electronics, 7 Kehilat Saloniki St, TEL AVIV 61180,
Tel. +972 3 645 0444, Fax. +972 3 649 1007

Italy: PHILIPS SEMICONDUCTORS, Piazza IV Novembre 3,
20124 MILANO, Tel. +39 2 6752 2531, Fax. +39 2 6752 2557

Japan: Philips Bldg 13-37, Kohnan 2-chome, Minato-ku, TOKYO 108,
Tel. +81 3 3740 5130, Fax. +81 3 3740 5077

Korea: Philips House, 260-199 Itaewon-dong, Yongsan-ku, SEOUL,
Tel. +82 2 709 1412, Fax. +82 2 709 1415

Malaysia: No. 76 Jalan Universiti, 46200 PETALING JAYA, SELANGOR,
Tel. +60 3 750 5214, Fax. +60 3 757 4880

Mexico: 5900 Gateway East, Suite 200, EL PASO, TEXAS 79905,
Tel. +9-5 800 234 7381

Middle East: see Italy

Netherlands: Postbus 90050, 5600 PB EINDHOVEN, Bldg. VB,
Tel. +31 40 27 82785, Fax. +31 40 27 88399

New Zealand: 2 Wagener Place, C.P.O. Box 1041, AUCKLAND,
Tel. +64 9 849 4160, Fax. +64 9 849 7811

Norway: Box 1, Manglerud 0612, OSLO,
Tel. +47 22 74 8000, Fax. +47 22 74 8341

Philippines: Philips Semiconductors Philippines Inc.,
106 Valero St. Salcedo Village, P.O. Box 2108 MCC, MAKATI,
Metro MANILA, Tel. +63 2 816 6380, Fax. +63 2 817 3474

Poland: Ul. Lukiska 10, PL 04-123 WARSZAWA,
Tel. +48 22 612 2831, Fax. +48 22 612 2327

Portugal: see Spain

Romania: see Italy

Russia: Philips Russia, Ul. Usatcheva 35A, 119048 MOSCOW,
Tel. +7 095 926 5361, Fax. +7 095 564 8323

Singapore: Lorong 1, Toa Payoh, SINGAPORE 1231,
Tel. +65 350 2538, Fax. +65 251 6500

Slovakia: see Austria

Slovenia: see Italy

South Africa: S.A. PHILIPS Pty Ltd., 195-215 Main Road Martindale,
2092 JOHANNESBURG, P.O. Box 7430 Johannesburg 2000,
Tel. +27 11 470 5911, Fax. +27 11 470 5494

South America: Rua do Rocio 220, 5th floor, Suite 51,
04552-903 São Paulo, SÃO PAULO - SP, Brazil,
Tel. +55 11 821 2333, Fax. +55 11 829 1849

Spain: Balmes 22, 08007 BARCELONA,
Tel. +34 3 301 6312, Fax. +34 3 301 4107

Sweden: Kottbygatan 7, Akalla, S-16485 STOCKHOLM,
Tel. +46 8 632 2000, Fax. +46 8 632 2745

Switzerland: Allmendstrasse 140, CH-8027 ZÜRICH,
Tel. +41 1 488 2686, Fax. +41 1 481 7730

Taiwan: PHILIPS TAIWAN Ltd., 23-30F, 66,
Chung Hsiao West Road, Sec. 1, P.O. Box 22978,
TAIPEI 100, Tel. +886 2 382 4443, Fax. +886 2 382 4444

Thailand: PHILIPS ELECTRONICS (THAILAND) Ltd.,
209/2 Sanpavuth-Bangna Road Prakanong, BANGKOK 10260,
Tel. +66 2 745 4090, Fax. +66 2 398 0793

Turkey: Talatpasa Cad. No. 5, 80640 GÜLTEPE/ISTANBUL,
Tel. +90 212 279 2770, Fax. +90 212 282 6707

Ukraine: PHILIPS UKRAINE, 4 Patrice Lumumba str., Building B, Floor 7,
252042 KIEV, Tel. +380 44 264 2776, Fax. +380 44 268 0461

United Kingdom: Philips Semiconductors Ltd., 276 Bath Road, Hayes,
MIDDLESEX UB3 5BX, Tel. +44 181 730 5000, Fax. +44 181 754 8421

United States: 811 East Arques Avenue, SUNNYVALE, CA 94088-3409,
Tel. +1 800 234 7381

Uruguay: see South America

Vietnam: see Singapore

Yugoslavia: PHILIPS, Trg N. Pasica 5/v, 11000 BEOGRAD,
Tel. +381 11 825 344, Fax. +381 11 635 777

For all other countries apply to: Philips Semiconductors, Marketing & Sales Communications,
Building BE-p, P.O. Box 218, 5600 MD EINDHOVEN, The Netherlands, Fax. +31 40 27 24825

Internet: <http://www.semiconductors.philips.com>

© Philips Electronics N.V. 1996

SCA51

All rights are reserved. Reproduction in whole or in part is prohibited without the prior written consent of the copyright owner.

The information presented in this document does not form part of any quotation or contract, is believed to be accurate and reliable and may be changed without notice. No liability will be accepted by the publisher for any consequence of its use. Publication thereof does not convey nor imply any license under patent- or other industrial or intellectual property rights.

Printed in The Netherlands

517021/1200/02/pp20

Date of release: 1996 Sep 02

Document order number: 9397 750 00921

Let's make things better.

Philips
Semiconductors



PHILIPS