

# TOSHIBA MOS MEMORY PRODUCTS

TC5565APL-10, TC5565APL-12, TC5565APL-15  
 TC5565AFL-10, TC5565AFL-12, TC5565AFL-15

## DESCRIPTION

The TC5565APL/AFL is 65,536 bit static random access memory organized as 8,192 words by 8 bits using CMOS technology, and operates from a single 5V supply. Advanced circuit techniques provide both high speed and low power features with a maximum operating current of 5mA/MHz and maximum access time of 100ns/120ns/150ns.

When CE2 is a logical low or  $\overline{\text{CE1}}$  is a logical high, the device is placed in low power standby mode in which standby current is 2uA typically. The TC5565APL/AFL has three control inputs. Two chip enable ( $\overline{\text{CE1}}$ , CE2) allow for device selection and data retention control, and an output enable input ( $\overline{\text{OE}}$ ) provides fast memory access. Thus the TC5565APL/AFL is suitable for use in various microprocessor application systems where high speed, low power, and battery back up are required.

The TC5565APL also features pin compatibility with the 64K bit EPROM (TMM2764D).

RAM and EPROM are then interchangeable in the same socket, resulting in flexibility in the definition of the quantity of RAM versus EPROM in microprocessor application systems. The TC5565APL is offered in a dual-in-line 28 pin standard plastic package. The TC5565AFL is offered in 28 pin mini Flat Package.

## FEATURES

- Low Power Dissipation  
27.5mW/MHz(Max.) operating
- Standby Current: 100uA(Max.) Ta=70°C
- Access Time  
TC5565APL/AFL-10 : 100ns(Max.)  
TC5565APL/AFL-12 : 120ns(Max.)  
TC5565APL/AFL-15 : 150ns(Max.)
- 5V Single Power Supply
- Power Down Features: CE2,  $\overline{\text{CE1}}$
- Fully Static Operation

Data Retention Supply Voltage: 2.0-5.5V

- Directly TTL Compatible  
: All Inputs and Outputs
- Pin Compatible with 2764 type EPROM
- TC5565APL Family (Package Type)

| Package Type                  | Device Name |
|-------------------------------|-------------|
| 600 mil DIP                   | TC5565APL   |
| 300 mil DIP<br>(Slim Package) | *TC5563APL  |
| Flat Package<br>(SOP)         | TC5565AFL   |

\* See TC5563APL Technical Data.

## PIN CONNECTION (TOP VIEW)

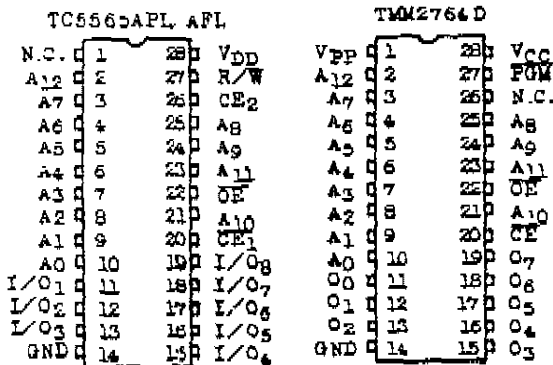

|                               |                          |
|-------------------------------|--------------------------|
| AO-A12                        | Address Inputs           |
| R/W                           | Read/Write Control Input |
| $\overline{\text{OE}}$        | Output Enable Input      |
| $\overline{\text{CE1}}$ , CE2 | Chip Enable Inputs       |
| I/O1 - I/O8                   | Data Input/Output        |
| V <sub>DD</sub>               | Power (+5V)              |
| GND                           | Ground                   |
| N.C.                          | No Connection            |

## BLOCK DIAGRAM

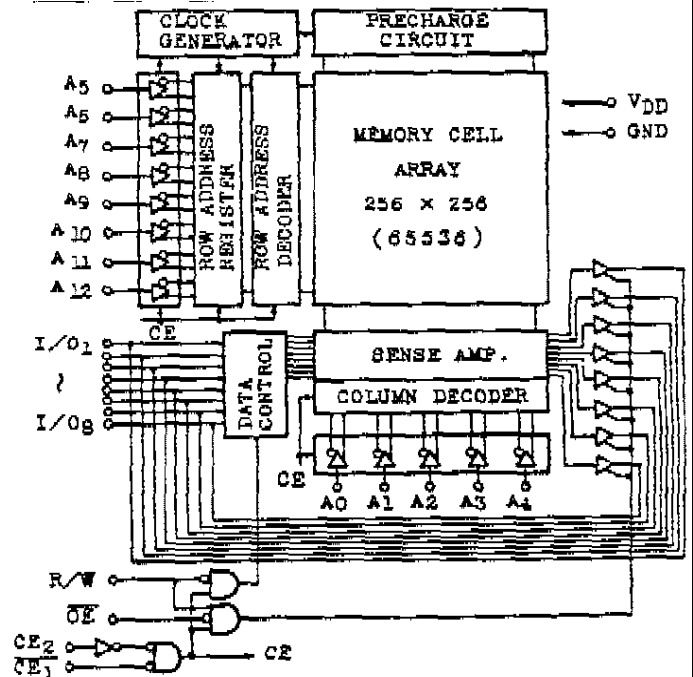

**TC5565APL-10, TC5565APL-12, TC5565APL-15**  
**TC5565AFL-10, TC5565AFL-12, TC5565AFL-15**

| OPERATION MODE  | \CE1 | CE2 | \OE | R/W | 1/01-T/08        | POWER            |
|-----------------|------|-----|-----|-----|------------------|------------------|
| Read            | L    | H   | L   | H   | D <sub>OUT</sub> | I <sub>DDO</sub> |
| Write           | L    | H   | *   | L   | D <sub>IN</sub>  | I <sub>DDO</sub> |
| Output Deselect | L    | H   | H   | H   | High-Z           | I <sub>DDO</sub> |
| Standby         | H    | *   | *   | *   | High-Z           | I <sub>DDS</sub> |
|                 |      | L   | *   | *   | High-Z           | I <sub>DDS</sub> |

MAXIMUM RATINGS

| SYMBOL              | ITEM                     | RATING       | UNIT   |
|---------------------|--------------------------|--------------|--------|
| V <sub>DD</sub>     | Power Supply Voltage     | -0.3~7.0     | v      |
| V <sub>IN</sub>     | Input Voltage            | *-0.3~7.0    | v      |
| V <sub>I/O</sub>    | Input and Output Voltage | -0-5-VDD+0.5 | v      |
| P <sub>D</sub>      | Power Dissipation        | 1.0/0.6**    | W      |
| T <sub>solder</sub> | Soldering Temperature    | 260-10       | °C sec |
| T <sub>stg</sub>    | Storage Temperature      | -55~150      | °C     |
| T <sub>opr</sub>    | Operating Temperature    | 0-70         | °C     |

\*-3.0V at pulse width 50ns MAX. \*\*Flat package

D.C RECOMMENDED OPERATING CONDITIONS

| SYMBOL          | PARAMETER                     | MIN. | Typ. | MAX.                 | UNIT |
|-----------------|-------------------------------|------|------|----------------------|------|
| V <sub>DD</sub> | Power Supply Voltage          | 4.5  | 5.0  | 5.5                  | v    |
| V <sub>IH</sub> | Input High Voltage            | 2.2  | -    | V <sub>DD</sub> +0.3 | v    |
| V <sub>IL</sub> | Input Low Voltage             | -0.3 | -    | 0.8                  | V    |
| V <sub>DH</sub> | Data-Retention Supply Voltage | 2.0  | -    | 5.5                  | V    |

**TC5565APL-10, TC5565APL-12, TC5565APL-15**  
**TC5565AFL-10, TC5565AFL-12, TC5565AFL-15**

D.C and OPERATING CHARACTERISTICS (Ta=0~70°C, V<sub>DD</sub> = 5V±10%)

| SYMBOL             | PARAMETER              | TEST CONDITION                                                                                                                                                           | MIN.                      | TYP. | MAX. | UNIT |    |
|--------------------|------------------------|--------------------------------------------------------------------------------------------------------------------------------------------------------------------------|---------------------------|------|------|------|----|
| I <sub>IL</sub>    | Input Leakage Current  | V <sub>IN</sub> =0~V <sub>DD</sub>                                                                                                                                       | -                         | -    | ±1.0 | μA   |    |
| I <sub>OH</sub>    | Output High Current    | VOH-2-4V                                                                                                                                                                 | -1.0                      | -    |      | mA   |    |
| I <sub>OL</sub>    | Output Low Current     | VOL-0.4V                                                                                                                                                                 | 4.0                       | -    |      | mA   |    |
| I <sub>LO</sub>    | Output Leakage Current | V <sub>IH</sub> or CE2-VOL or<br>\CE1 = V <sub>IH</sub> or CE2=V <sub>OL</sub> Or R/W = V <sub>IL</sub><br>or \OE=V <sub>IH</sub><br>V <sub>OUT</sub> =0~V <sub>DD</sub> | -                         | -    | ±1.0 | μA   |    |
| I <sub>DD01</sub>  | Operating Current      | t <sub>cycle</sub> =1.0us                                                                                                                                                |                           |      | 10   | mA   |    |
|                    |                        | TC5565APL-10<br>TC5565AFL-10                                                                                                                                             | t <sub>cycle</sub> =100ns | -    | -    | 45   | mA |
|                    |                        | TC5565APL-12<br>TC5565AFL-12                                                                                                                                             | t <sub>cycle</sub> =120ns | -    | -    | 40   | mA |
|                    |                        | TC5565A?L-15<br>TC5565AFL-15                                                                                                                                             | t <sub>cycle</sub> =150ns | -    | -    | 35   | mA |
| I <sub>DD02</sub>  | Operating Current      | t <sub>cycle</sub> =1.0us                                                                                                                                                | -                         | -    | 5    | mA   |    |
|                    |                        | TC5565APL-10<br>TC5565AFL-10                                                                                                                                             | t <sub>cycle</sub> =100ns | -    | -    | 40   | mA |
|                    |                        | TC5565AFL-12<br>TC5565AFL-12                                                                                                                                             | t <sub>cycle</sub> =120ns | -    | -    | 35   | mA |
|                    |                        | TC5565APL-15<br>TC5565AFL-15                                                                                                                                             | t <sub>cycle</sub> =150ns | -    | -    | 30   | mA |
| I <sub>DDS1</sub>  | Standby Current        | \CE1 = V <sub>IH</sub> or CE2 = V <sub>IL</sub>                                                                                                                          |                           |      | 3    | mA   |    |
| *I <sub>DDS2</sub> |                        | \CE1 = V <sub>DD</sub> - 0.2V or<br>CE2 = 0.2V                                                                                                                           | V <sub>DD</sub> = 5.5V    | -    | 2    | 100  | μA |
|                    |                        |                                                                                                                                                                          | V <sub>DD</sub> = 3.0V    | -    | 1    | 50   | μA |

Note \* In standby mode with \CE1 >= V<sub>DD</sub> - 0.2V, these specification limits are guaranteed under the condition of CE2 >= V<sub>DD</sub> - 0.2V or CE2 <= 0.2V.

CAPACITANCE (Ta=25°C)

| SYMBOL           | PARAMETER          | TEST CONDITION         | MIN. | TYP. | MAX. | UNIT |
|------------------|--------------------|------------------------|------|------|------|------|
| C <sub>IN</sub>  | Input Capacitance  | V <sub>IN</sub> = GND  | -    | -    | 10   | pF   |
| C <sub>OUT</sub> | Output Capacitance | V <sub>OUT</sub> = GND | -    | -    | 10   | pF   |

\* This parameter periodically sampled is not 100% tested.

**TC5565APL-10, TC5565APL-12, TC5565APL-15**  
**TC5565AFL-10, TC5565AFL-12, TC5565AFL-15**

**A.C. CHARACTERISTICS** (Ta=0~70°C, V<sub>DD</sub> = 5V±10%)

**Read Cycle**

| SYMBOL           | PARAMETER                                  | TC5565APL-10<br>TC5565AFL-10 |      | TC5565APL-12<br>TC5565AFL-12 |      | TC5565APL-15<br>TC5565AFL-15 |      |
|------------------|--------------------------------------------|------------------------------|------|------------------------------|------|------------------------------|------|
|                  |                                            | MIN.                         | MAX. | MIN.                         | MAX. | MIN.                         | MAX. |
| t <sub>RC</sub>  | Read Cycle Time                            | 100                          | -    | 120                          | -    | 150                          | -    |
| t <sub>ACC</sub> | Address Access Time                        | -                            | 100  | -                            | 120  | -                            | 150  |
| t <sub>COL</sub> | \CE1 Access Time                           | -                            | 100  | -                            | 120  | -                            | 150  |
| t <sub>CO2</sub> | CE2 Access Time                            | -                            | 100  | -                            | 120  | -                            | 150  |
| t <sub>OE</sub>  | Output Enable to Output Valid              | -                            | 50   | -                            | 60   | -                            | 70   |
| t <sub>COE</sub> | Chip Enable (\CE1, CE2) to Output in Low-Z | 10                           | -    | 10                           | -    | 15                           | -    |
| t <sub>OEE</sub> | Output Enable to Output in Low-Z           | 5                            | -    | 5                            | -    | 5                            | -    |
| t <sub>OD</sub>  | Chip Enable (CE1, CE2) to Output in High-Z | -                            | 35   | -                            | 40   | -                            | 50   |
| t <sub>ODO</sub> | Output Enable to Output in High-Z          | -                            | 35   | -                            | 40   | -                            | 50   |
| t <sub>OH</sub>  | Output Data Hold Time                      | 20                           | -    | 20                           | -    | 20                           | -    |

**Write Cycle**

| SYMBOL           | PARAMETER                      | TC5565APL-10<br>TC5565AFL-10 |      | TC5565APL-12<br>TC5565AFL-12 |      | TC5565APL- 5<br>TC5565AFL- 5 |       |
|------------------|--------------------------------|------------------------------|------|------------------------------|------|------------------------------|-------|
|                  |                                | MIN.                         | MAX. | MIN.                         | MAX. | MIN.                         | MAX.. |
| t <sub>WC</sub>  | Write Cycle Time               | 100                          | -    | 120                          | -    | 150                          | -     |
| t <sub>WP</sub>  | Write Pulse Width              | 60                           | -    | 70                           | -    | 90                           | -     |
| t <sub>CW</sub>  | Chip Selection to End of Write | 80                           | -    | 85                           | -    | 100                          | -     |
| t <sub>AS</sub>  | Address Set up Time            | 0                            | -    | 0                            | -    | 0                            | -     |
| t <sub>WR</sub>  | Write Recovery Time            | 0                            | -    | 0                            | -    | 0                            | -     |
| t <sub>ODW</sub> | R/W to Output High-Z           | -                            | 35   | 0                            | 40   | -                            | 50    |
| t <sub>OEW</sub> | R/W to Output Low-Z            | 5                            | -    | 5                            | -    | 10                           | -     |
| t <sub>DS</sub>  | Data Set up Time               | 40                           | -    | 50                           | -    | 60                           | -     |
| t <sub>DH</sub>  | Data Hold Time                 | 0                            | -    | 0                            | -    | 0                            | -     |

**A.C. TEST CONDITION**

|                                 |                  |                      |
|---------------------------------|------------------|----------------------|
| Output Load                     |                  | : 100pF + 1 TTL Gate |
| Input Pulse Level               |                  | : 0.6V, 2.4V         |
| Timing Measurement              | V <sub>IN</sub>  | : 0.8V, 2.2V         |
| Reference Level                 | V <sub>OUT</sub> | : 0.8V, 2.2V         |
| t <sub>r</sub> , t <sub>f</sub> |                  | : 5ns                |

TC5565APL-10, TC5565APL-12, TC5565APL-15  
 TC5565AFL-10, TC5565AFL-12, TC5565AFL-15

TIMING WAVEFORMS  
 READ CYCLE (1)

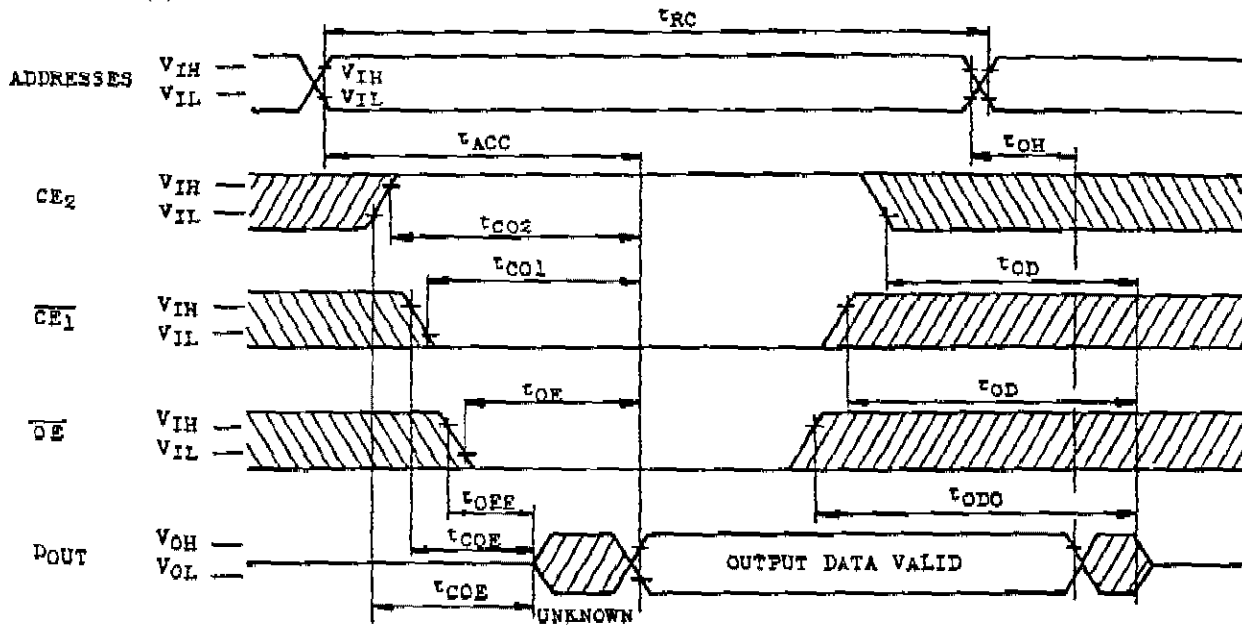

WRITE CYCLE 1 (4) (R/W Controlled Write)

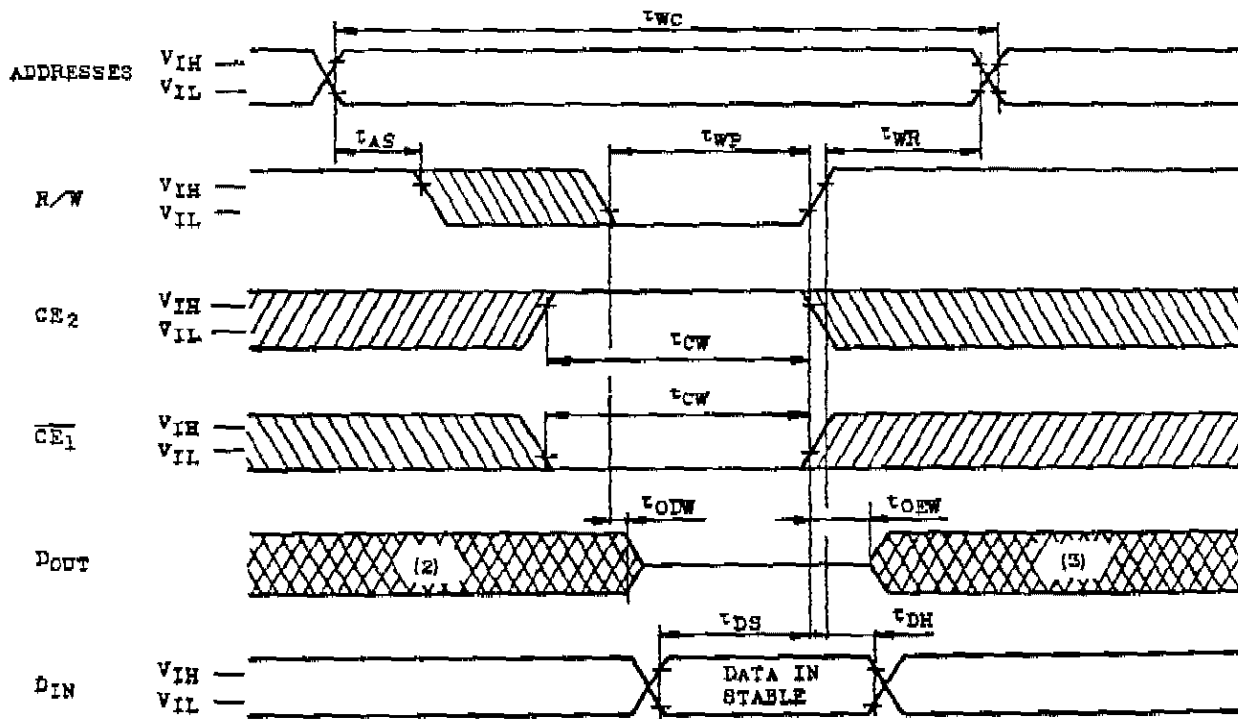

TC5565APL-10, TC5565APL-12, TC5565APL-15  
 TC5565AFL-10, TC5565AFL-12, TC5565AFL-15

WRITE CYCLE 2 (4) (\overline{CE1} Controlled Write)

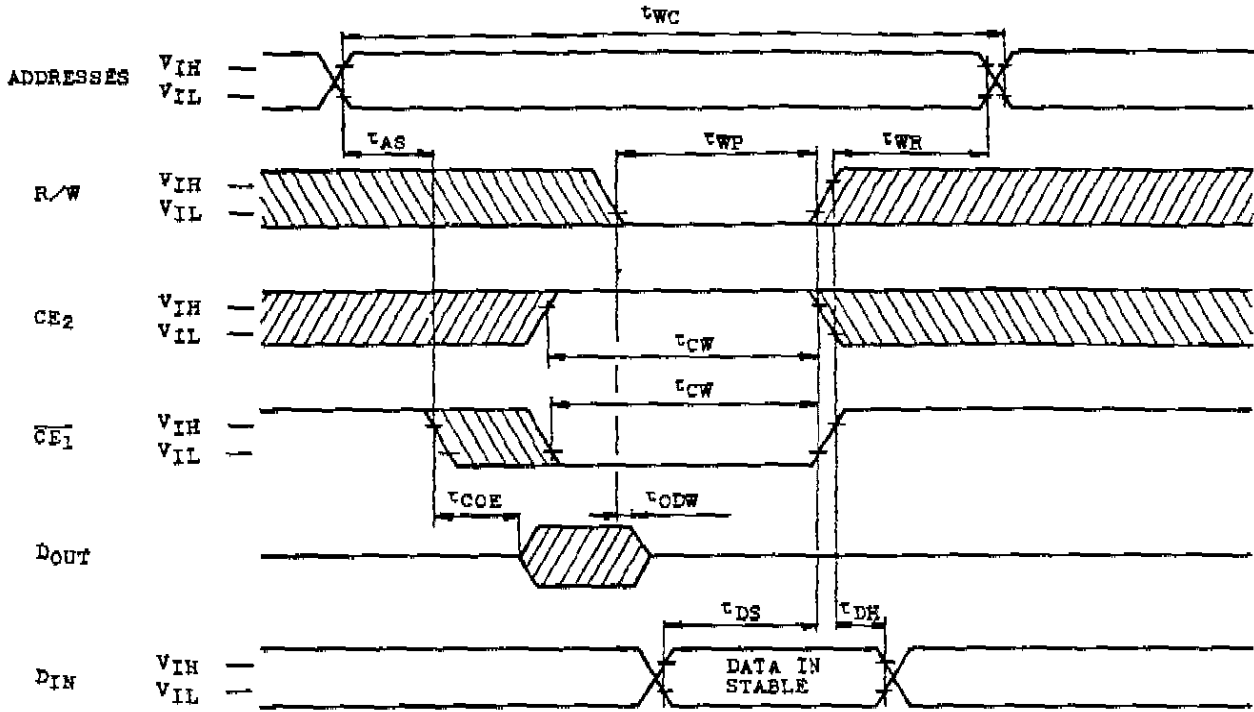

WRITE CYCLE 3 (4) (CE2 Controlled Write)

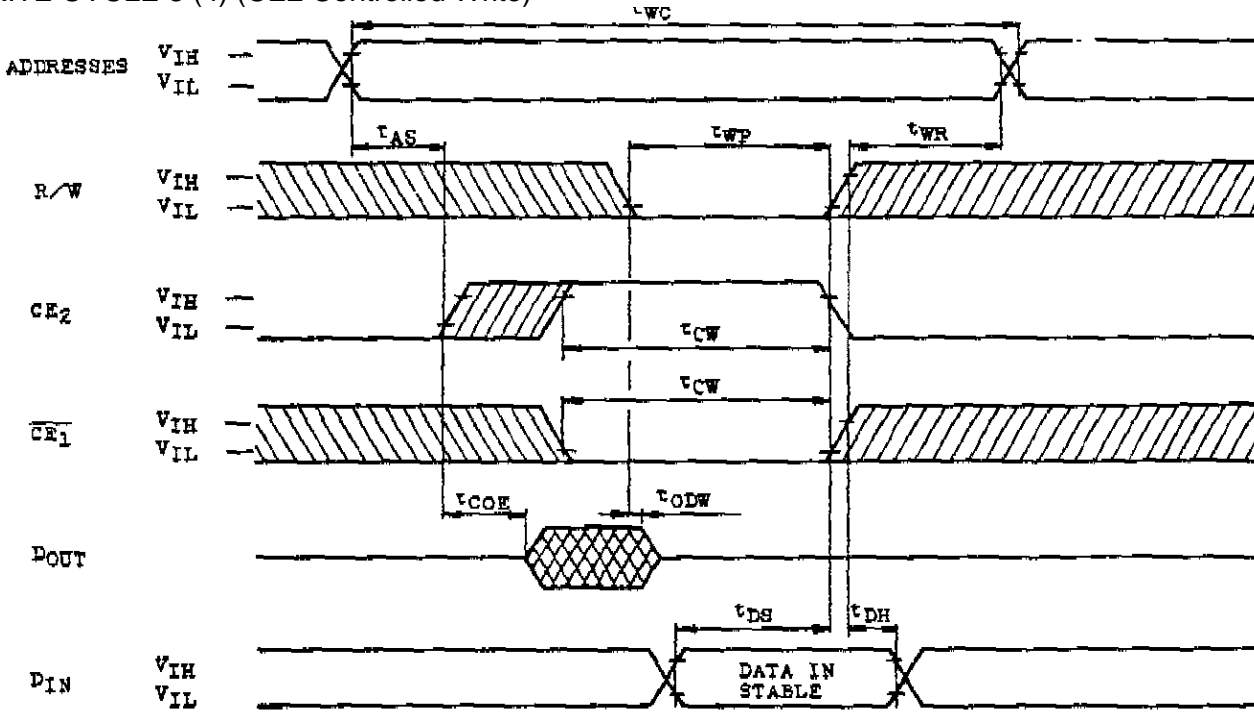

**TC5565APL-10, TC5565APL-12, TC5565APL-15  
TC5565AFL-10, TC5565AFL-12, TC5565AFL-15**

Note 1. R/W is High for Read Cycle.

2. Assuming that \CE1 Low transition of CE2 High transition occurs coincident with or after R/W Low transition, Outputs remain in a high impedance state.
3. Assuming that \CE1 High transition or CE2 Low transition occurs coincident with or prior to R/W High transition, Outputs remain in a high impedance state.
4. Assuming that \OE is High for Write Cycle, Outputs are in high impedance state during this period.

**DATA RETENTION CHARACTERISTICS (Ta=0~70°C)**

| SYMBOL           | PARAMETER                               | MIN.                | TYP. | MAX. | UNIT |
|------------------|-----------------------------------------|---------------------|------|------|------|
| V <sub>DH</sub>  | Data Retention Supply Voltage           | 2.0                 | -    | 5.5  | V    |
| I <sub>DD2</sub> | Stand by Supply Current                 | VDD=3.0V            | -    | 50   | uA   |
|                  |                                         | VDD=5.5V            | -    | 100  |      |
| t <sub>CDR</sub> | Chip Deselection to Data Retention Mode | 0                   | -    | -    | us   |
| t <sub>R</sub>   | Recovery Mode                           | t <sub>RC</sub> (1) | -    | -    | us   |

Note (1) : Read cycle Time.

**\CE1 Controlled Data Retention Mode (2)**

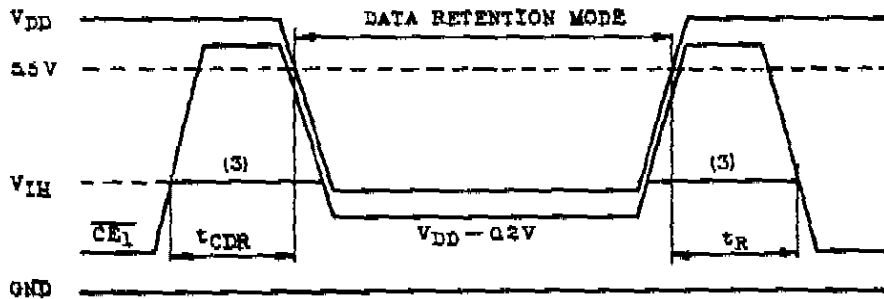

**CE2 Controlled Data Retention Mode (4)**

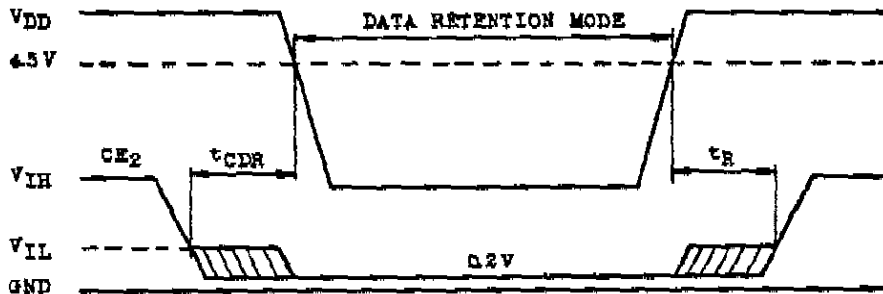

## TC5565APL-10, TC5565APL-12, TC5565APL-15 TC5565AFL-10, TC5565AFL-12, TC5565AFL-15

- Note 2 : In  $\overline{\text{CE1}}$  controlled data retention mode, minimum standby current mode is achieved under the condition of  $\text{CE2} \leq 0.2\text{V}$  Or  $\text{CE2} \geq V_{\text{DD}} - 0.2\text{V}$ .
- 3 : If the  $V_{\text{IH}}$  of  $\overline{\text{CE1}}$  is 2.2V in operation,  $I_{\text{DDSI}}$  current flows during the period that the  $V_{\text{DD}}$  voltage is going down from 4.5V to 2.4V,
- 4 ; In  $\text{CE2}$  controlled data retention mode, minimum standby current mode is achieved under the condition of  $\text{CE2} \leq 0.2\text{V}$ .

### DEVICE INFORMATION

The TC5565APL/AFL is an synchronous RAM using address activated circuit technology, thus the internal operation is synchronous. Then once row address change occur, the precharge operation is executed by internal pulse generated from row address transient. Therefore the peak current flows only after row address change, as shown in the following figure. This peak current may induce the noise on  $V_{\text{DD}}$  /GND lines. Thus the use of about 0.1 $\mu\text{F}$  decoupling capacitor for every device is recommended to eliminate such noise.

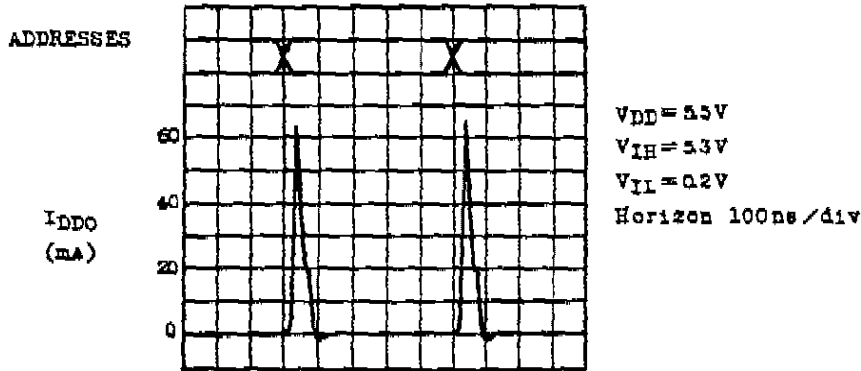

Fig. TYPICAL CURRENT WAVEFORMS



TC5565APL-10, TC5565APL-12, TC5565APL-15  
 TC5565AFL-10, TC5565AFL-12, TC5565AFL-15

DIP 28 PIN OUTLINE DRAWING (6D28A-P)

Unit in mm

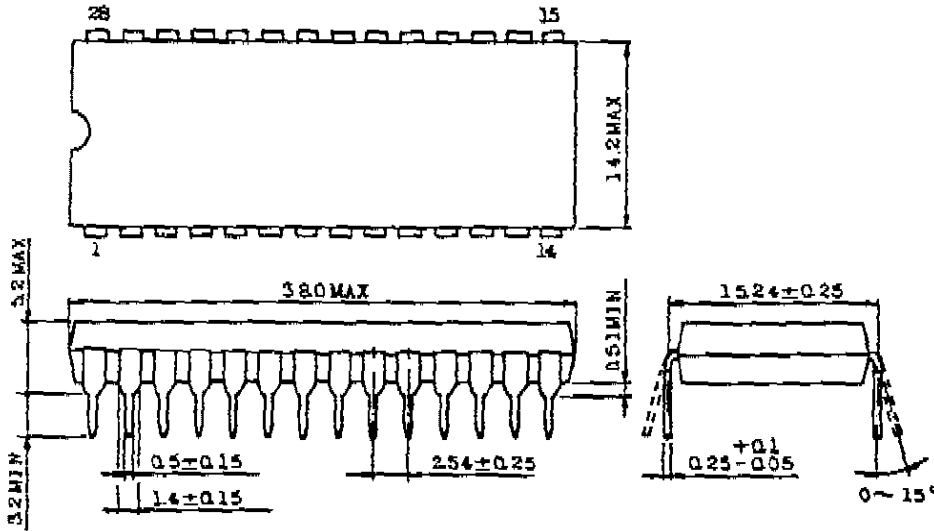

Note) Lead pitch is 2.54 and tolerance is  $\pm 0.25$  against theoretical center of each lead that is obtained on the basis of No.1 and No.28 leads.

MFP 28 PIN OUTLINE DRAWING (F28GC-P)

Unit in mm

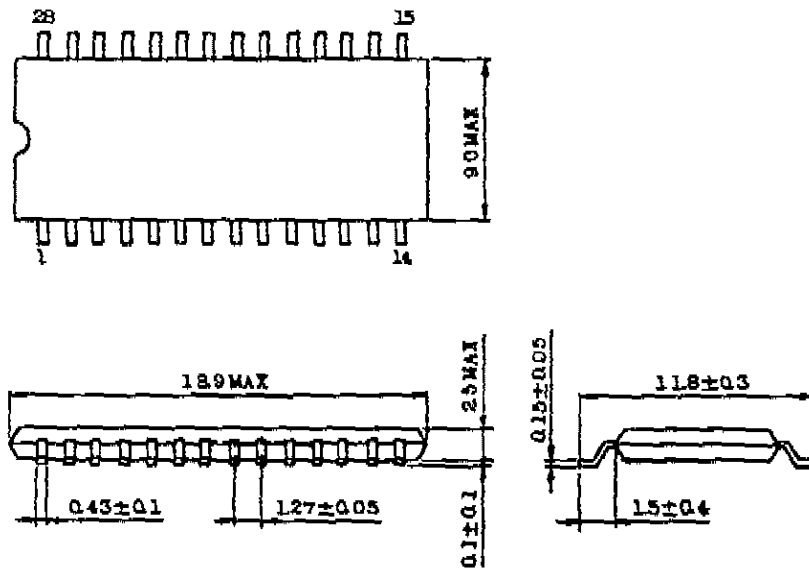

Note) Lead pitch is 1.27 and tolerance is  $\pm 0.12$  against theoretical center of each lead that is obtained on the basis of No.1 and No.28 leads.