

TA8504F

HIGH SPEED COMPARATOR

FEATURES

- Pulse delay : 1.6ns (Typ.)
- Differential ECL output
- 50Ω Line drive output
- 8pin mini flat package
- -5V single power supply

BLOCK DIAGRAM

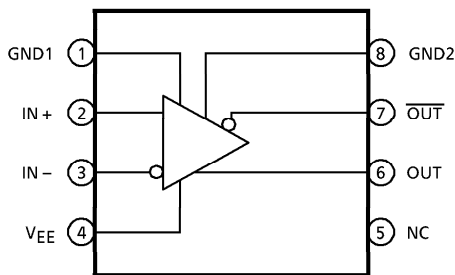

MAXIMUM RATINGS (Ta = 25°C)

CHARACTERISTIC	SYMBOL	RATING	UNIT
Supply Voltage	V_{EE}	0.3 ~ -6.0	V
Differential Input Voltage	DV_{IN}	± 3	V
Common Mode Input Voltage	CMV_{IN}	-0.3 ~ V_{EE}	V
Power Dissipation	P_D	(*) 300	mW
Operating Temperature	T_{opr}	-20 ~ 85	°C
Storage Temperature	T_{stg}	-55 ~ 150	°C

Recommended Operating Voltage : $V_{EE} = -5.5 \sim -4.5V$, $T_a = -20 \sim 70^\circ C$

(Note *) Shown here is data for the single unit of IC only and when mounted on a substrate, power dissipation can be made larger than this. However, as it varies largely depending upon the state of mounted on a substrate, it shall be examined thoroughly.

(Note **) As this product is weak to surge voltage, please handle carefully.

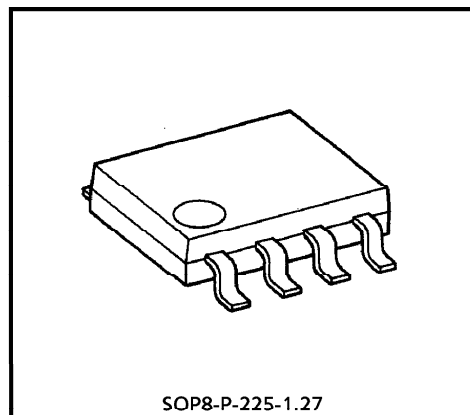

Weight : 0.1g (Typ.)

PIN CONNECTION (TOP VIEW)

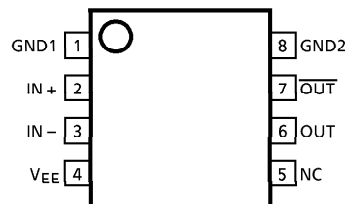

961001EBA2

- TOSHIBA is continually working to improve the quality and the reliability of its products. Nevertheless, semiconductor devices in general can malfunction or fail due to their inherent electrical sensitivity and vulnerability to physical stress. It is the responsibility of the buyer, when utilizing TOSHIBA products, to observe standards of safety, and to avoid situations in which a malfunction or failure of a TOSHIBA product could cause loss of human life, bodily injury or damage to property. In developing your designs, please ensure that TOSHIBA products are used within specified operating ranges as set forth in the most recent products specifications. Also, please keep in mind the precautions and conditions set forth in the TOSHIBA Semiconductor Reliability Handbook.
- The products described in this document are subject to foreign exchange and foreign trade control laws.
- The information contained herein is presented only as a guide for the applications of our products. No responsibility is assumed by TOSHIBA CORPORATION for any infringements of intellectual property or other rights of the third parties which may result from its use. No license is granted by implication or otherwise under any intellectual property or other rights of TOSHIBA CORPORATION or others.
- The information contained herein is subject to change without notice.

ELECTRICAL CHARACTERISTICS ($V_{EE} = -5V$, $R_L = 50\Omega$, $T_a = 25^\circ C$)

CHARACTERISTIC		SYMBOL	TEST CIR-CUIT	TEST CONDITION	MIN.	TYP.	MAX.	UNIT
Input Offset Voltage		—	—	$R_S < 500\Omega$	-10	—	10	mV
Input Bias Current		—	—	—	—	20	40	μA
Input Offset Current		—	—	—	—	—	10	μA
Supply Current		I_{EE}	—	$V_{EE} = -5.5V$	—	26	37	mA
Propagation Delay		t_{pLH}	—	(Note 1)	—	1.6	2.6	ns
		t_{pHL}	—	(Note 1)	—	1.6	2.6	
Rise Time	20~80%	t_r	—	(Note 1)	—	1.0	1.8	ns
Fall Time	20~80%	t_f	—	(Note 1)	—	0.7	1.6	
Common Mode Input Voltage Range		—	—	—	-2.5	—	-0.8	V
Output Voltage		V_{OH}	—	$R_L = 50\Omega$ is load per -2V.	-1.025	—	-0.88	V
		V_{OL}	—		-1.81	—	-1.62	
Input Capacitance		—	—	—	—	3.5	—	pF
Open Loop Gain		—	—	—	—	70	—	dB

(Note 1) Input/Output conditions are as illustrated below.

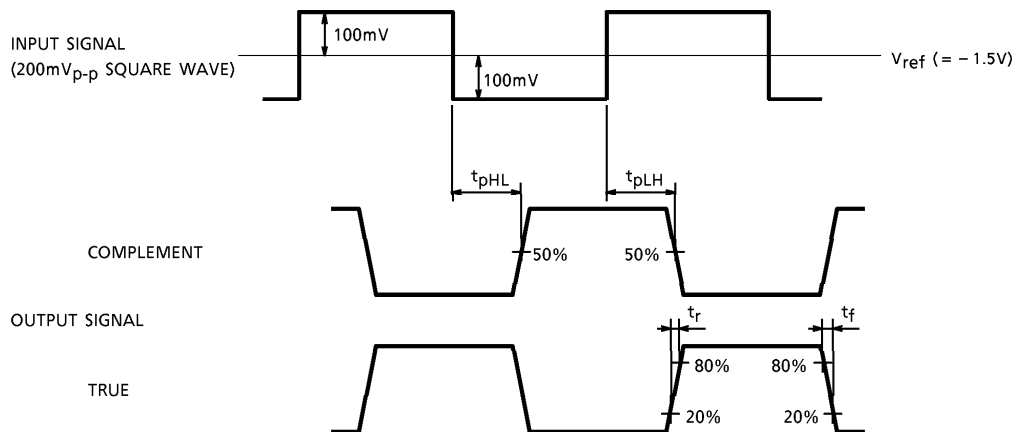

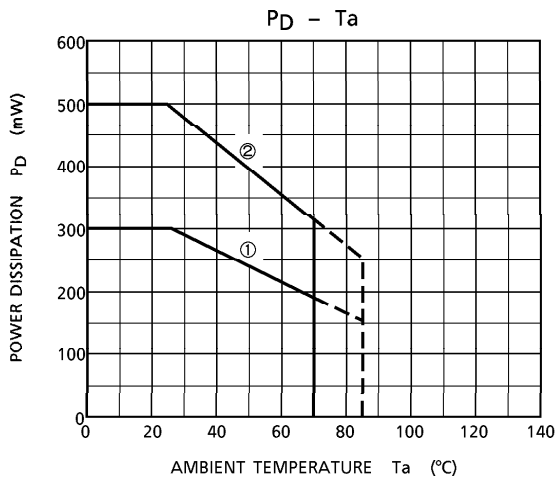

(Note 1) ① is data of a single unit of IC only.
(Note 2) ② is reference data when mounted on a glass epoxy resin substrate in $20 \times 20 \times 1.8\text{mm}^3$, and the copper laminated area is 60% of the substrate.

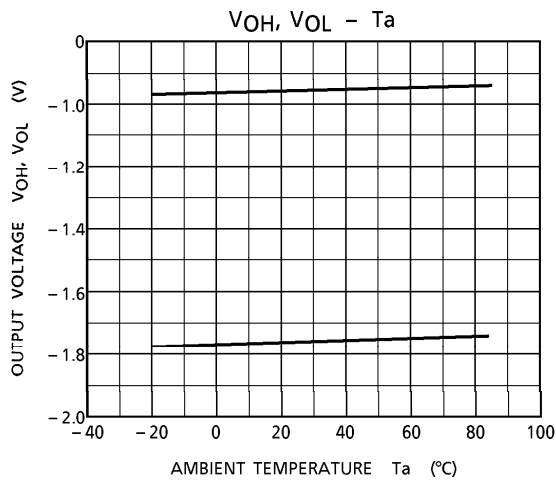

OUTLINE DRAWING
SOP8-P-225-1.27

Unit : mm

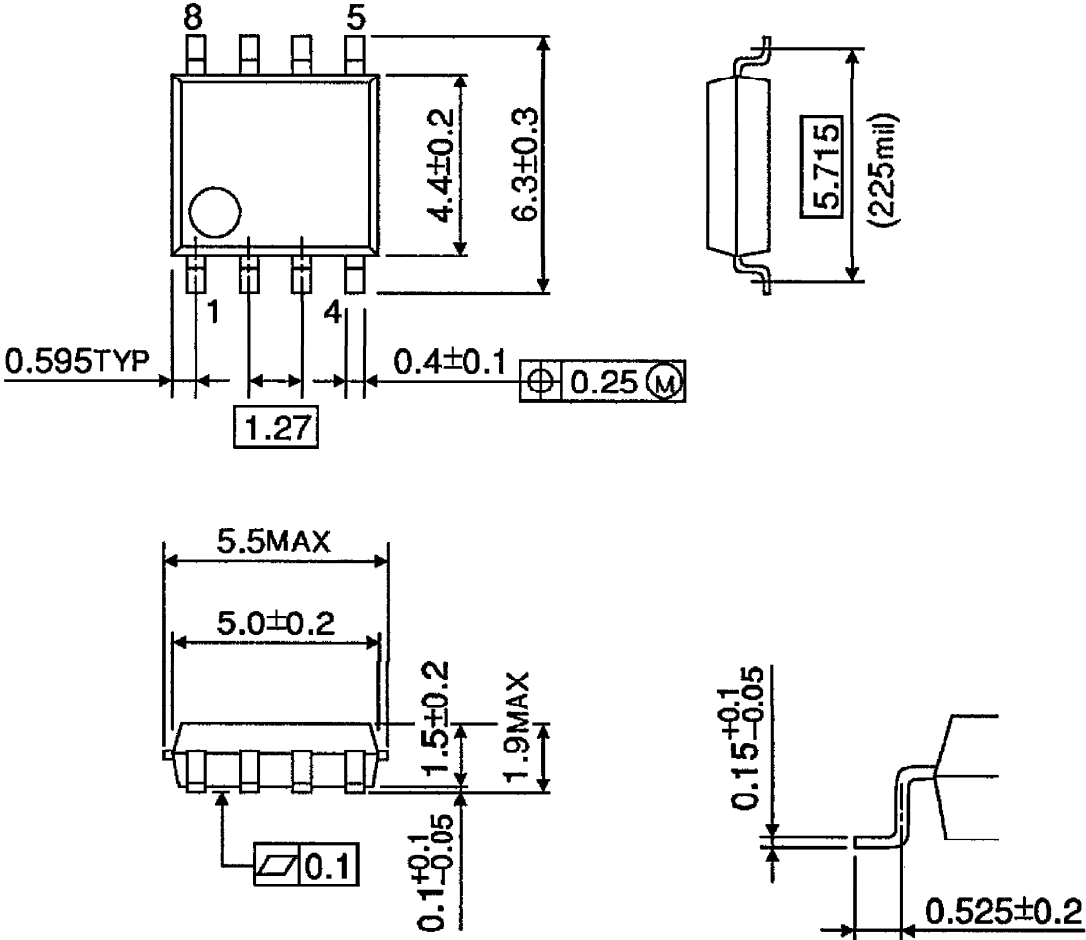

Weight : 0.1g (Typ.)