

UTC TA8127 LINEAR INTEGRATED CIRCUIT

3V AM / FM 1 CHIP TUNER IC

DESCRIPTION

The UTC TA8127 is the AM / FM 1 chip tuner IC, which is designed for Portable Radios and 3V Headphone Radios.

FEATURES

- *Built-in FM F/E, AM / FM IF and FM MPX
- *AM Detector Coil and IF Coupling Condenser are not needed.
- *Operating Supply Voltage Range
Vcc=1.8~7.0V (Ta=25°C)

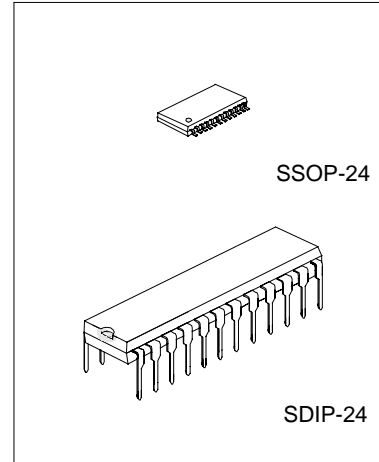

*Pb-free plating product number: TA8127L

BLOCK DIAGRAM

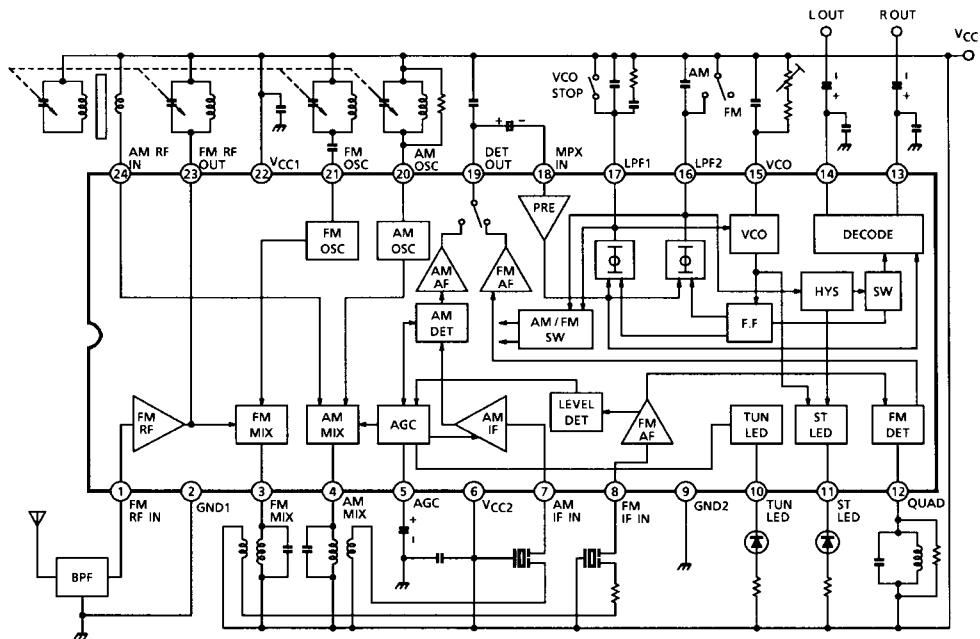

UTC TA8127 LINEAR INTEGRATED CIRCUIT

ABSOLUTE MAXIMUM RATINGS (TA=25°C)

PARAMETER	SYMBOL	VALUE	UNIT
Supply Voltage	Vcc	8	V
LED Current	ILED	10	mA
LED Voltage	VLED	8	V
Power Dissipation	PD (note)		mW
SSOP		400	
SDIP		1200	
Operating Temperature	TOPR	-25 to +75	°C
Storage Temperature	TSTG	-55 to +150	°C

Note: Derated above 25°C in the proportion of 9.6mW/°C for SDIP and of 3.2mW/°C for SSOP.

ELECTRICAL CHARACTERISTICS

(Unless otherwise specified, Ta=25°C, Vcc=3V, F/E: f=83MHz, fm=1kHz

FM IF : f=10.7MHz, Δf=±22.5kHz, fm=1kHz

AM : f=1MHz, MOD=30%, fm=1kHz

MPX : fm=1kHz)

PARAMETER		SYMBOL	*	TEST CONDITIONS	MIN	TYP	MAX	UNIT
Supply Current	Icc(FM)	Icc	1	Vin=0, FM Mode		13.2	20.0	mA
	Icc(AM)	Icc	1	Vin=0, AM Mode		8.4	13.5	mA
F / E	Input Limiting Voltage	Vin(lim.)	1	-3dB Limiting		10.0		dBμV EMF
	Local OSC Voltage	Vosc	2	fosc=72.3MHz		105		mVrms
FM IF	Input Limiting Voltage	Vin(lim.) IF	1	-3dB Limiting	40	46	53	dBμV EMF
	Recovered Output Voltage	Vod	1	Vin=80dBμV EMF	55	80	110	mVrms
	Signal to Noise Ratio	S/N	1	Vin=80dBμV EMF		70		dB
	Total Harmonic Distortion	THD	1	Vin=80dBμV EMF		0.4		%
	AM Rejection Ratio	AMR	1	Vin=80dBμV EMF		32		dB
AM	Lamp ON Sensitivity	VL	1	IL=1mA	45	51	56	dBμV EMF
	Gain	Gv	1	Vin=26dBμV EMF	40	70	110	mVrms
	Recovered Output Voltage	Vod	1	Vin=60dBμV EMF	55	80	110	mVrms
	Signal to Noise Ratio	S/N	1	Vin=60dBμV EMF		42		dB
	Total Harmonic Distortion	THD	1	Vin=60dBμV EMF		1.0		%
Pin 19 Output Resistance	R19	1	FM Mode AM Mode		0.75 12.5			kΩ

*TEST CIRCUIT

UTC TA8127 LINEAR INTEGRATED CIRCUIT

PARAMETER		SYMBOL	*	TEST CONDITIONS	MIN	TYP	MAX	UNIT	
MPX	Input Resistance	RIN	-			24		k Ω	
	Output resistance	ROUT	-			5		k Ω	
	Max. Composite Signal Input Voltage	Vin(max.) STEREO	1	L+R=90%, P=10%, fm=1kHz, THD=3%		350		mVrms	
	Separation	Sep	1	L+R=135mVrm, P=15mVrms	fm=100Hz		42		dB
					fm=1kHz	35	42		
					fm=10kHz		42		
	Total Harmonic Distortion	Monaural	THD (MONAURAL)	1	Vin=150mVrms		0.2		%
		Stereo	THD (STEREO)			L+R=135mVrm, P=15mVrms		0.2	
	Voltage Gain	GV(MPX)	1	Vin=150 mVrms	-5	-3	-1		dB
	Channel Balance	C.B.	1	Vin=150 mVrms	-2	0	2		dB
	Stereo Lamp Sensitivity	ON	V _L (ON)	1	Pilot Input		8	16	mVrms
		OFF	V _L (OFF)			Pilot Input	2	6	
	Stereo Lamp Hysteresis	V _H	1	To LED turn off from LED turn on		2			mVrms
	Capture Range	C.R.	1	P=15mVrms		\pm 3			%
Signal to Noise Ratio	S/N	1	Vin=150mVrms		70			dB	

*TEST CIRCUIT

UTC TA8127 LINEAR INTEGRATED CIRCUIT

TEST CIRCUIT 2

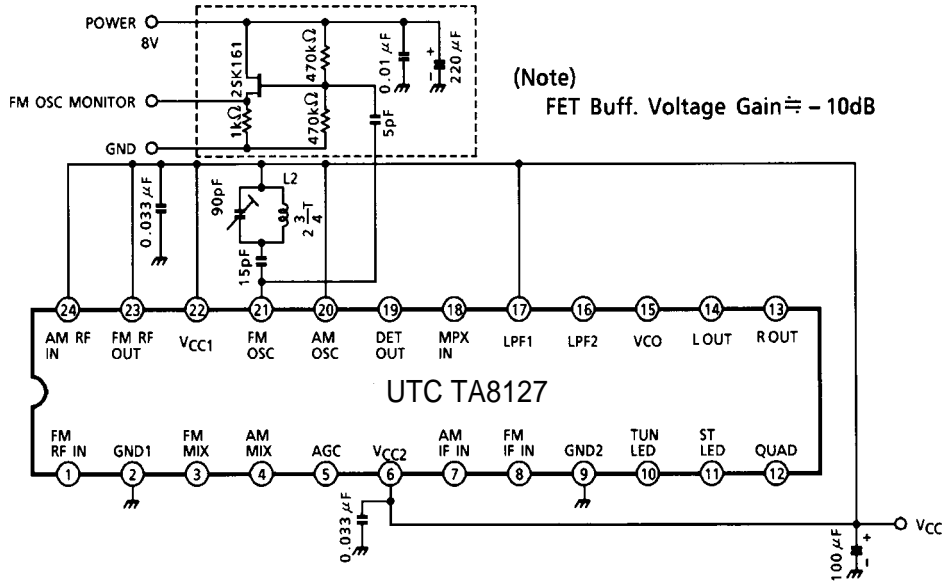

COIL DATA

COIL NO.	TEST FREQ. (Hz)	L (μH)	Co (pF)	Qo	TURNS					WIRE (mmΦ)	REFERENCE
					1-2	2-3	1-3	1-4	4-6		
L1 FM RF	100M			100				2.5		0.5UEW	⑤ 53T-037-202
L2 FM OSC	100M			100			2.75			0.5UEW	⑤ 0258-244
L3 AM OSC	796K	288		115	13	73				0.08UEW	⑤ 4147-1356-038
T1 FM MIX	10.7M		75	100			13		2	0.1UEW	⑤ 2153-414-041
T2 AM MIX	455k		180	120			180		15	0.08UEW	⑤ 2150-2162-165
T3 FM DET	10.7M		47	165			16			0.09UEW	⑤ 2153-4095-122

⑤: SUMIDA ELECTRIC CO., LTD

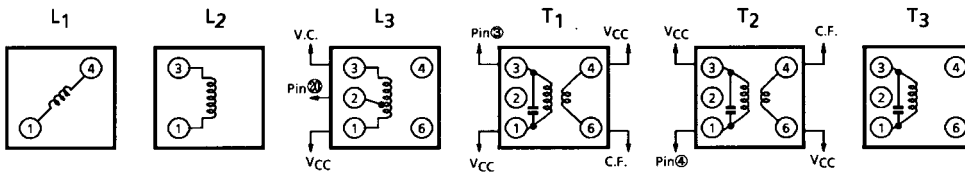

UTCTA8127 LINEAR INTEGRATED CIRCUIT

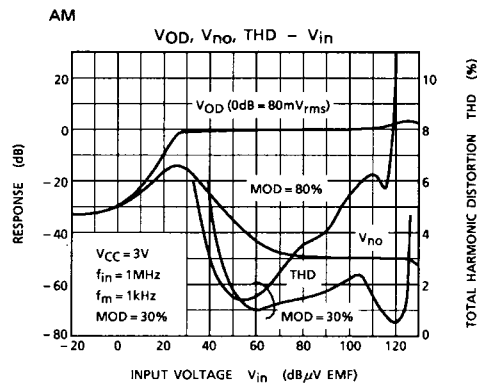
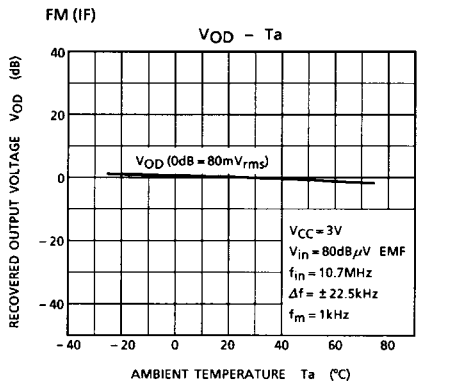
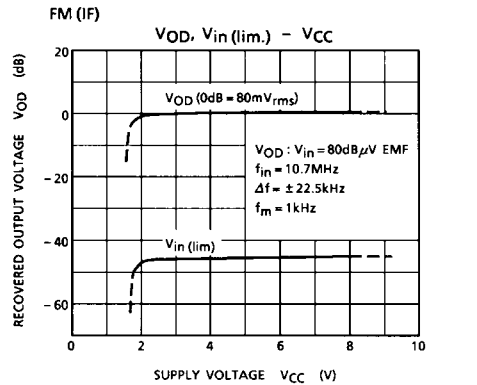
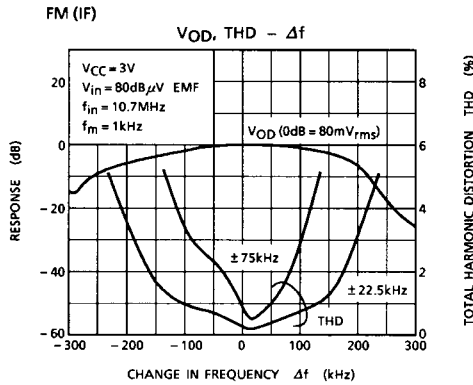
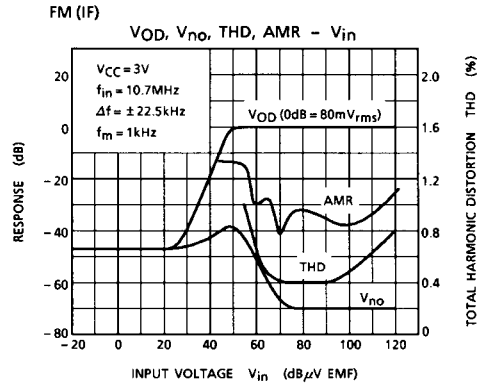
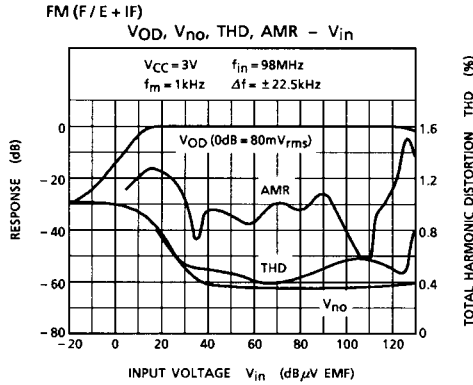

UTC TA8127 LINEAR INTEGRATED CIRCUIT

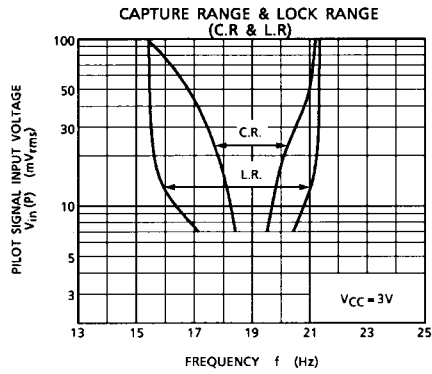
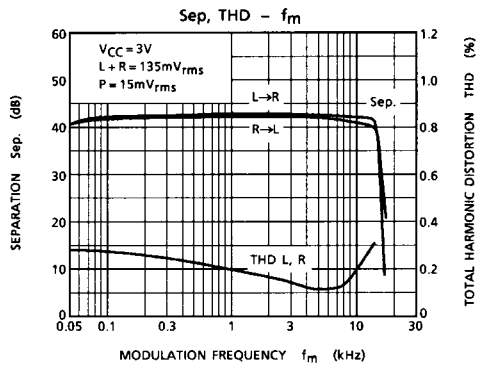
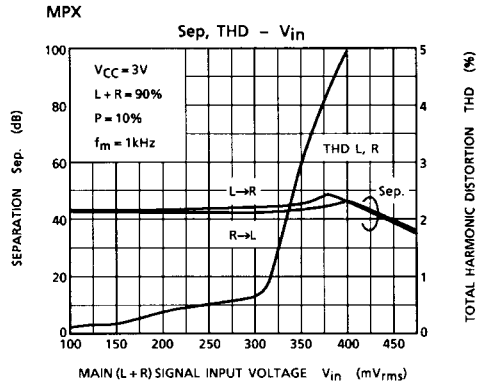
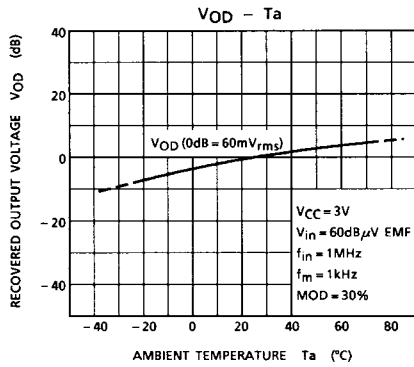
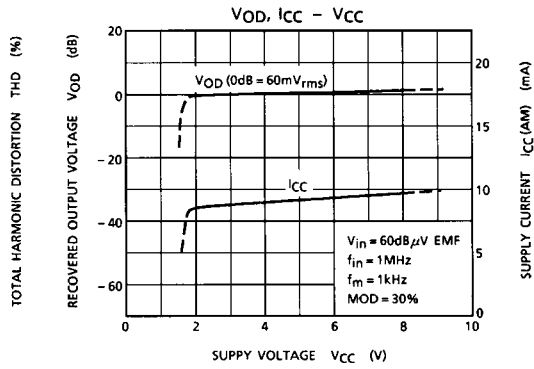
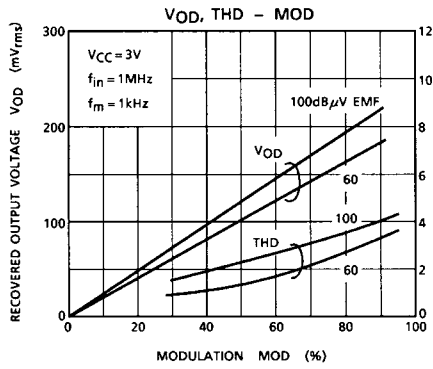

UTC TA8127 LINEAR INTEGRATED CIRCUIT

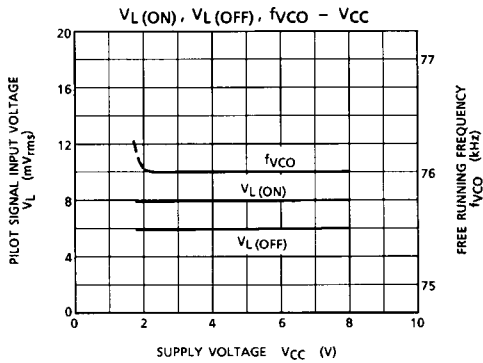
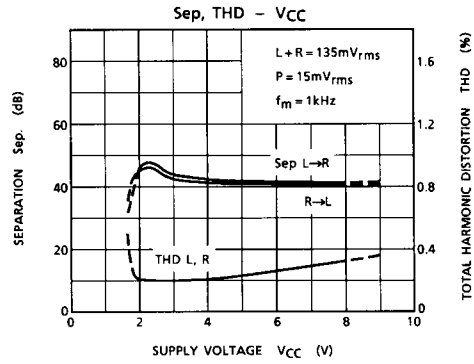
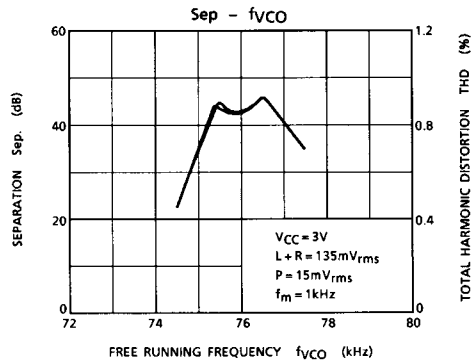

UTC assumes no responsibility for equipment failures that result from using products at values that exceed, even momentarily, rated values (such as maximum ratings, operating condition ranges, or other parameters) listed in products specifications of any and all UTC products described or contained herein. UTC products are not designed for use in life support appliances, devices or systems where malfunction of these products can be reasonably expected to result in personal injury. Reproduction in whole or in part is prohibited without the prior written consent of the copyright owner. The information presented in this document does not form part of any quotation or contract, is believed to be accurate and reliable and may be changed without notice.