

# TA7787AP / AF TA8110AP / AF

T-77-05-07

## AM/FM IF SYSTEM

TA7787AP/AF, TA8110AP/AF are the AM/FM IF SYSTEM ICs which are designed for Radio Cassette Players and 3V Head Phone Radios.

TA8110AP/AF is Upper Heterodyne use and TA7787AP/AF is Lower Heterodyne use.

- . AM Detector Coil and IF By-pass Condenser are not necessary.
- . Common Output for AM/FM
- . One Terminal Type AM Low Cut Circuit is built in.
- . AM OSC Circuit with ALC is adopted.
- . FM Soft Muting Circuit is built in.
- . A Terminal is provided to stop the FM MPX IC VCO during AM reception and when the FM signal is too weak.
- . Low Supply Current. ( $V_{CC}=3V$ ,  $T_a=25^\circ C$ )  
 FM :  $I_{CC(1)}=5.3mA$ (Typ.)  
 AM :  $I_{CC(2)}=4.8mA$ (Typ.)
- . Operating Supply Voltage Range. ( $T_a=25^\circ C$ )  
 $V_{CC(opr)}=1.8\sim 8.0V$  (TYP:  $V_{CC}=3V$ )

### MAXIMUM RATINGS ( $T_a=25^\circ C$ )

CHARACTERISTIC		SYMBOL	RATING	UNIT
Supply Voltage		$V_{CC}$	8	V
LED Current		$I_{LED}$	10	mA
LED Voltage		$V_{LED}$	10	V
Power Dissipation	DIP-16	$P_D$	750	mW
	(Note 1) MFP-16	(Note 2)	350	
Operating Temperature		$T_{opr}$	-25~75	$^\circ C$
Storage Temperature		$T_{stg}$	-55~150	$^\circ C$

Note 1 : TA7787AP, TA8110AP...DIP-16,  
 TA7787AF, TA8110AF...MFP-16

Note 2 : Derated above  $T_a=25^\circ C$  in the proportion of 6mW for DIP-16 and of 2.8mW for MFP-16.

Unit in mm

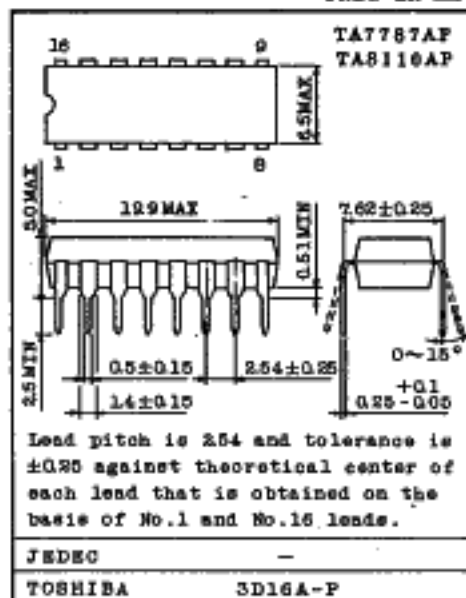

Weight : 1.00g

Unit in mm

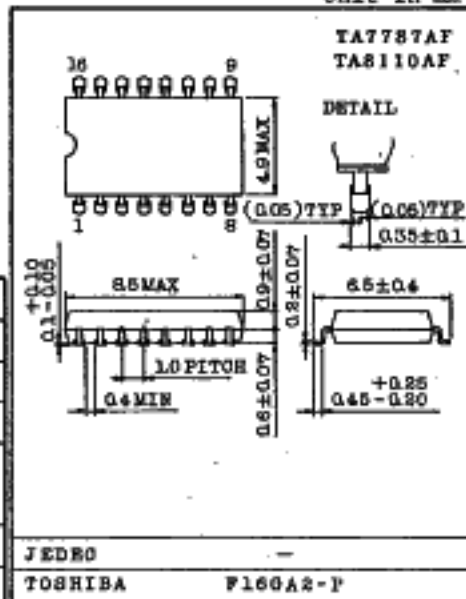

Weight : 0.14g

AUDIO LINEAR IC

# TA7787AP / AF TA8110AP / AF

T-77-05-07

BLOCK DIAGRAM

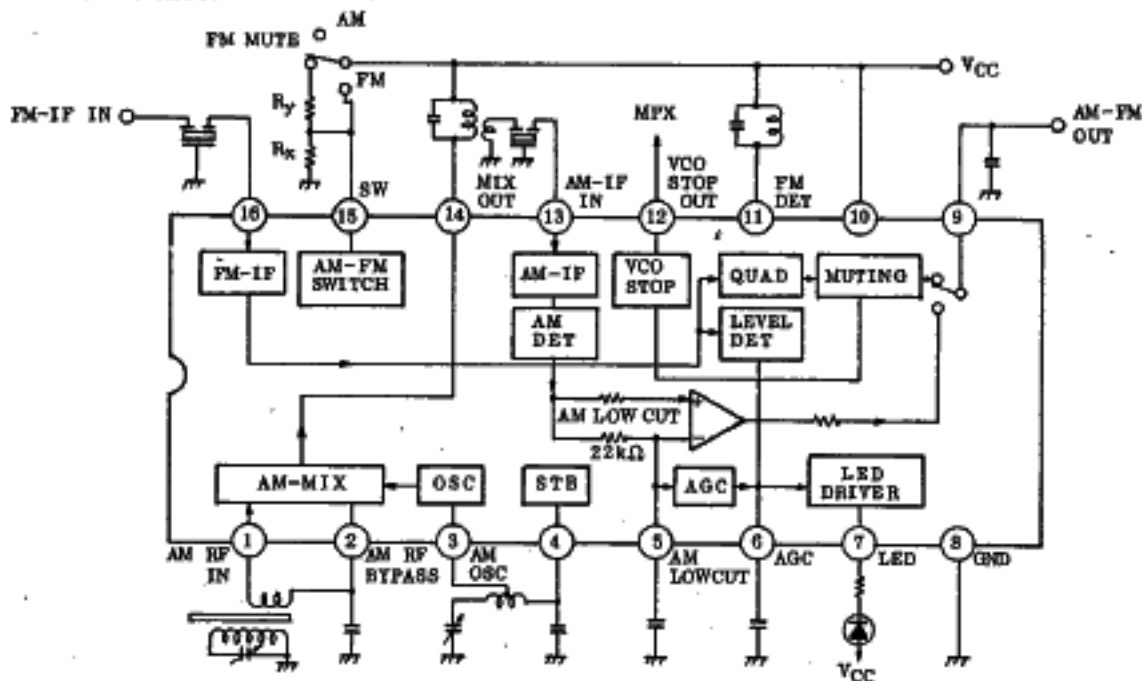

TERMINAL VOLTAGE AT NO SIGNAL ( $V_{CC}=3V$ ,  $T_a=25^\circ C$ )

PIN No.	ITEM	SYMBOL	TYPICAL VALUE		UNIT
			AM	FM	
1	(AM RF IN)	V1	1.1	1.1	V
2	(AM RF BY-PASS)	V2	1.1	1.1	V
3	(AM OSC)	V3	1.6	1.6	V
4	(STB)	V4	1.6	1.6	V
5	(AM LOW CUT)	V5	0.4	0.3	V
6	(AGC)	V6	0.4	0.35	V
7	(LED)	V7	-	-	V
8	(GND)	V8	0	0	V
9	(AM-FM OUT)	V9	1.1	1.1	V
10	(VCC)	V10	3.0	3.0	V
11	(FM DET)	V11	3.0	3.0	V
12	(VCO STOP OUT)	V12	-	-	V
13	(AM IF IN)	V13	1.1	1.1	V
14	(AM MIX OUT)	V14	3.0	3.0	V
15	(AM-FM SWITCH)	V15	0	-	V
16	(FM IF IN)	V16	1.1	1.1	V

**TOSHIBA**

# TA7787AP / AF TA8110AP / AF

T-77-05-07

## ELECTRICAL CHARACTERISTICS

Unless otherwise specified,  $T_a=25^\circ\text{C}$ ,  $V_{CC}=3\text{V}$

FM :  $f=10.7\text{MHz}$ ,  $\Delta f=\pm 22.5\text{kHz}$ ,  $f_m=1\text{kHz}$

AM :  $f=1\text{MHz}$ ,  $\text{Mod}=30\%$ ,  $f_m=1\text{kHz}$

CHARACTERISTIC	SYMBOL	TEST CIRCUIT	TEST CONDITION	MIN.	TYP.	MAX.	UNIT
Supply Current	$I_{CC(1)}$	1	FM Mode $V_{IN}=0$	-	5.3	8.2	mA
	$I_{CC(2)}$		AM Mode $V_{IN}=0$	-	4.8	7.5	
Input Limiting Voltage	$V_{IN(lim)}$	1	-3dB Limiting Point	-	43	49	dB $\mu$
Recovered Output Voltage	$V_{OD}$	1	$V_{IN}=80\text{dB}\mu$	55	80	110	mV <sub>rms</sub>
Signal to Noise Ratio	S/N	1	$V_{IN}=80\text{dB}\mu$ $\Delta f=22.5\text{kHz} \rightarrow 0$	-	68	-	dB
Total Harmonic Distortion	THD	1	$V_{IN}=80\text{dB}\mu$	-	0.1	-	%
AM Rejection Ratio	AMR	1	$V_{IN}=80\text{dB}\mu$	-	32	-	dB
Lamp ON Sensitivity	$V_L$	1	$I_L=1\text{mA}$	37	43	49	dB $\mu$
VCO Stop Sensitivity	$V_{stop}$	1		-	45	-	dB $\mu$
Muting Level	MUT	1	$R_x=22\text{k}\Omega$ , $R_y=22\text{k}\Omega$	-	33	-	dB
7 Pin Saturation Voltage	$V_{LED}$	1	$I_L=10\text{mA}$ , $V_6=1.2\text{V}$	-	80	200	mV
12 Pin Saturation Voltage	$V_{VCO}$	1	$I_{VCO}=100\mu\text{A}$	-	40	65	mV
Recovered Output Voltage	$V_{OD}$	1	$V_{IN}=60\text{dB}\mu$ , $V_6 \rightarrow \text{GND}$	50	75	100	mV <sub>rms</sub>
Signal to Noise Ratio	S/N	1	$V_{IN}=60\text{dB}\mu$	-	41	-	dB
Total Harmonic Distortion	THD	1	$V_{IN}=60\text{dB}\mu$	-	1.0	-	%
			$V_{IN}=100\text{dB}\mu$ , $\text{Mod}=80\%$	-	2.0	-	
Lamp ON Sensitivity	$V_L$	1	$I_L=1\text{mA}$	-	29	35	dB $\mu$
Gain	$G_V$	1	$V_{IN}=26\text{dB}\mu$	22	33	70	mV <sub>rms</sub>
Output Resistance	$R_{o9}$	1	FM Mode	-	0.5	-	k $\Omega$
			AM Mode	-	10	-	

\*  $V_{IN}$  OPEN Display

AUDIO LINEAR IC

# TA7787AP / AF TA8110AP / AF

T-77-05-07

TEST CIRCUIT 1

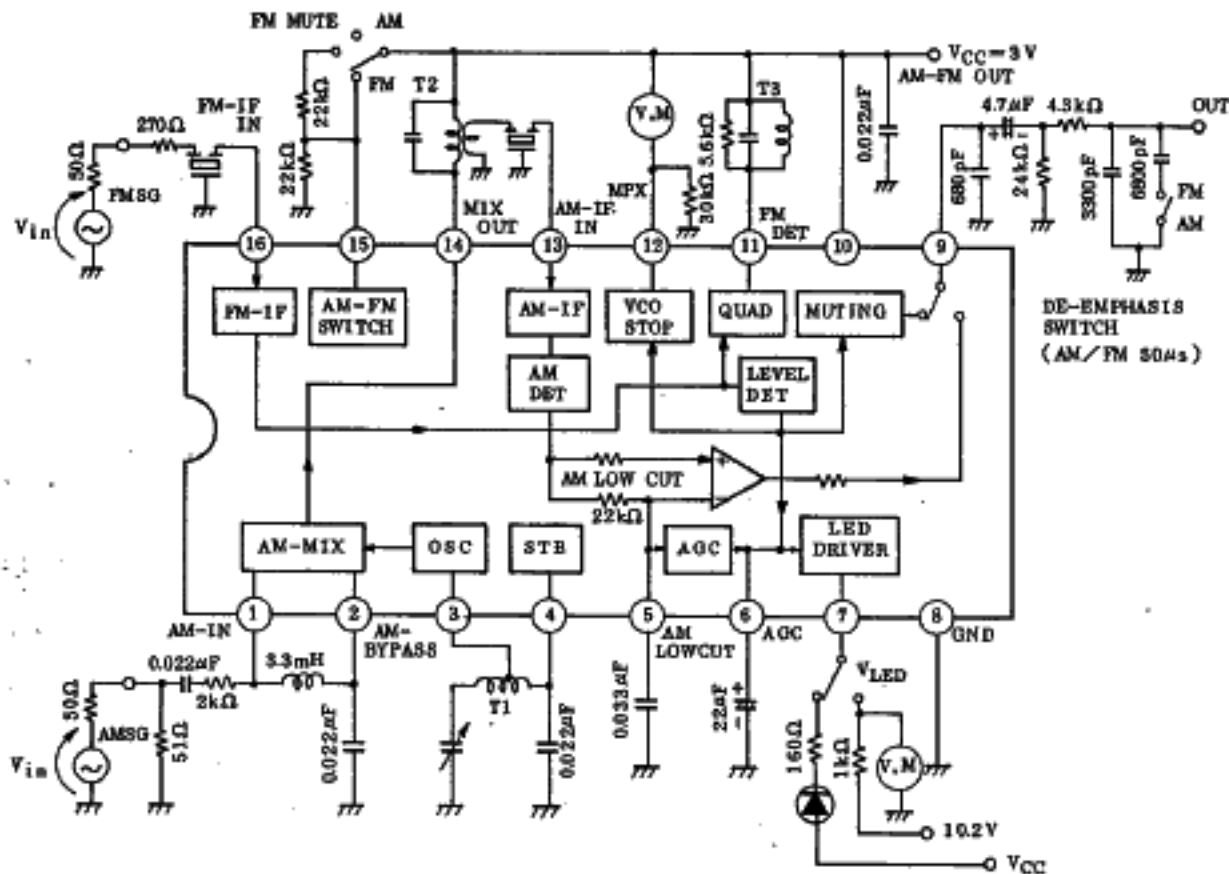

COIL DATA (TEST CIRCUIT)

S : SUMIDA ELECTRIC Co., Ltd.

COIL No.	f	L (μH)	C <sub>0</sub> (pF)	Q <sub>0</sub>	TURN				WIRE (mm)	REF. (COIL No.)
					1-2	2-3	1-3	4-6		
T1 AM OSC	796kHz	288		155	13	73			0.08 UEW	4147-1356-038
T2 AM IFT	455kHz		180	120			180	15	0.06 UEW	2150-2162-165
T3 FM DET	10.7MHz		47	165			16		0.09 UEW	2153-4095-122

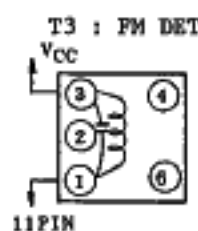
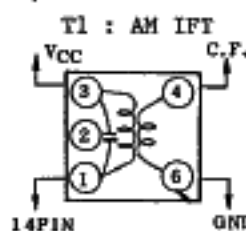
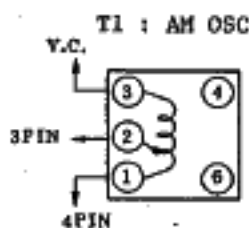

**TOSHIBA**

**INTERNAL CIRCUIT AND FUNCTIONAL DESCRIPTION**

**1. AM OSCILLATION CIRCUIT (Fig.1)**

For adopting the level control (ALC) circuit, the oscillation level is stabilized. The oscillation frequency can be made up to about 30MHz and can be applied to SW band. The relation of the oscillation voltage and the oscillation current to Q of the oscillation coil is shown in Graph 1.

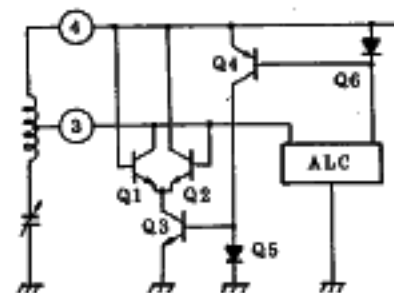

Fig.1 AM OSCILLATION CIRCUIT

**2. AM LOW-CUT CIRCUIT (Fig.2)**

This circuit can improve the clearness of the AM audio by decreasing the low-frequency content of the output signal during AM reception. The cut-off frequency  $f_L$  is determined by the internal resistance  $22k\Omega$ (Typ.) and the external capacitor C5 of ⑤ pin as following;

$$f_L = \frac{1}{2 \times \pi \times 22 \times 10^3 \times C5} \quad (\text{Hz})$$

By serially connection the resistance to the capacitor C5 between ⑤ pin and GND, the detection output level of AM can be reduced.

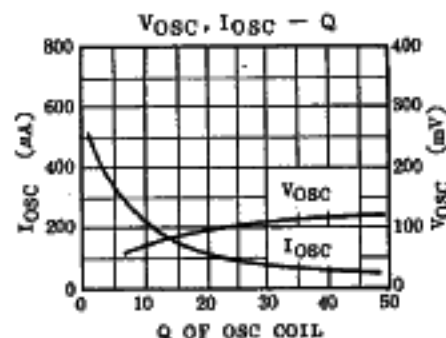

Graph 1 VOSC, IOSC - Q

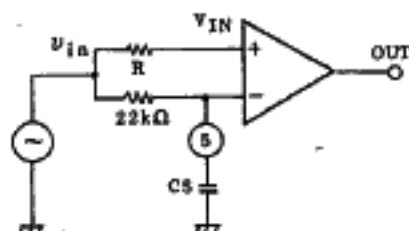
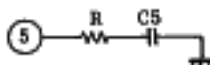
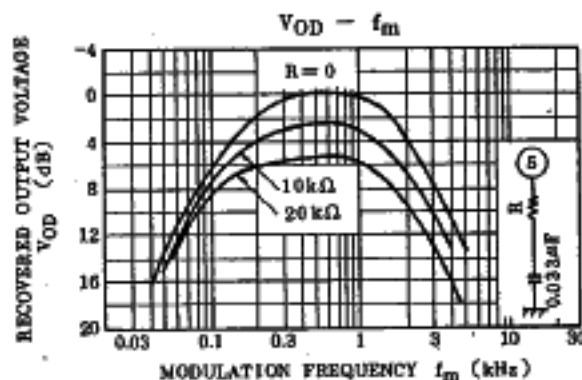

Fig.2 AM LOW CUT CIRCUIT



Graph 2 VOD - fm

**TA7787AP / AF**  
**TA8110AP / AF**

T-77-05-07

3. AGC CIRCUIT

The external capacitor C6 of (6) pin is the smoothing capacitor for AGC. The varying condition of the capacity value of C6 and the frequency characteristics of distortion are shown in Graph 3.

4. FM IF AND DETECTION CIRCUIT

The input impedance (16 pin) of IF amplifier is set at 330Ω(Typ.). S curve characteristics of FM detection output in TA7787AP/AF and TA8110AP/AF are reverse to each other, and when assembled with TA7378P (IC for FM front end with diode for AFC built-in), TA7787AP/AF becomes for the lower heterodyne use and TA8110AP/AF for the upper heterodyne use.

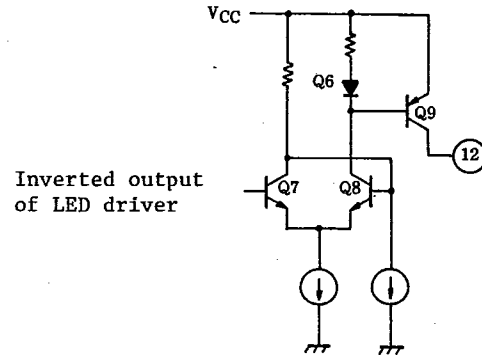
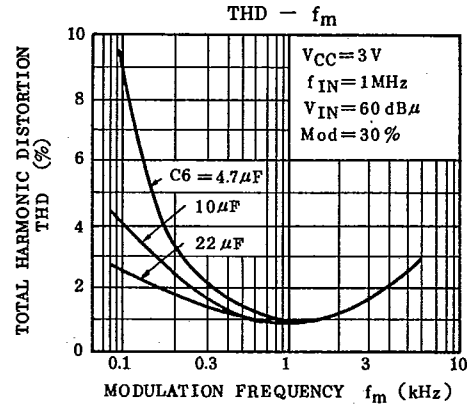
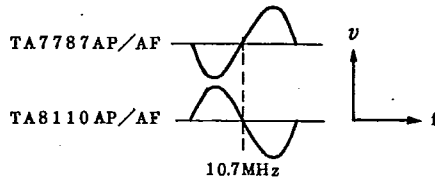

Fig.3 TERMINAL TO STOP VCO

5. FM/AM SWITCHING

FM/AM switching is made by the voltage of (15) pin.

- VCC ..... FM
- 0.7V < V15 < VCC ..... FM muting operation
- 0.7V or less ..... AM

**TA7787AP / AF**  
**TA8110AP / AF**

T-77-05-07

6. TERMINAL FOR MPX VCO STOP

By using (12) pin, VCO of MPX IC can be stopped. The output circuit is shown in Fig.3, and the connections to MPX ICs (TA7370P/F and TA7343AP/AF) are shown in Fig.4.

7. CONNECTION TO MPX IC

In case of connecting MPX IC secondarily to this IC to make the stereo function, it is conventionally necessary to switch the capacitor C9 with AM/FM in IF output. However, since the output impedance of TA7787AP/AF and TA8110AP/AF are changed over to 10kΩ in AM and 500Ω in FM, the frequency characteristics of AM/FM can easily be changed with a piece of the external capacitor C9 as shown in Fig.5.

The frequency characteristics in this state are shown in Fig.6.

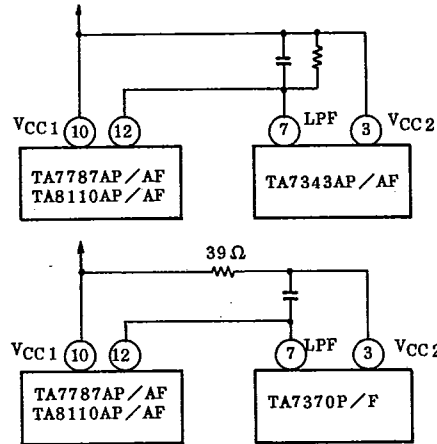

Fig.4 CONNECTION TO TA7343AP/AF AND TA7370P/F

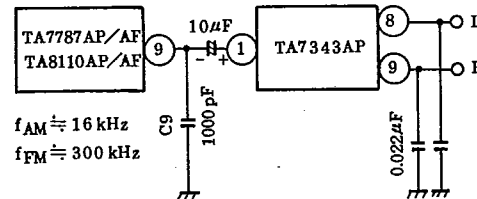

Fig.5 CONNECTION TO TA7343AP

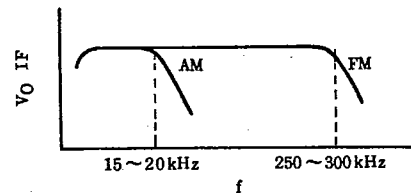
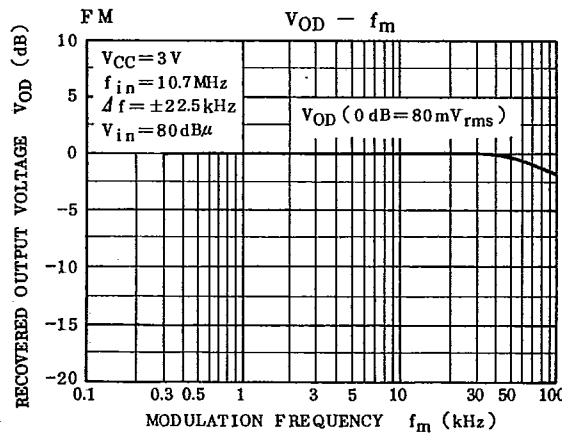
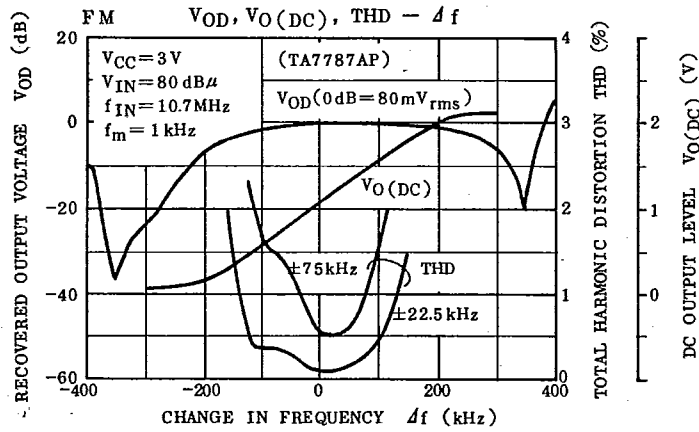
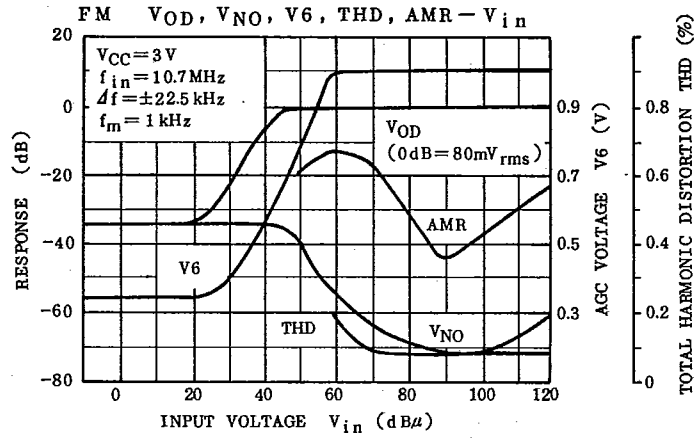

Fig.6 FREQUENCY CHARACTERISTICS OF DET OUTPUTS

**TA7787AP / AF**  
**TA8110AP / AF**

T-77-05-07





**TA7787AP / AF**  
**TA8110AP / AF**

T-77-05-07

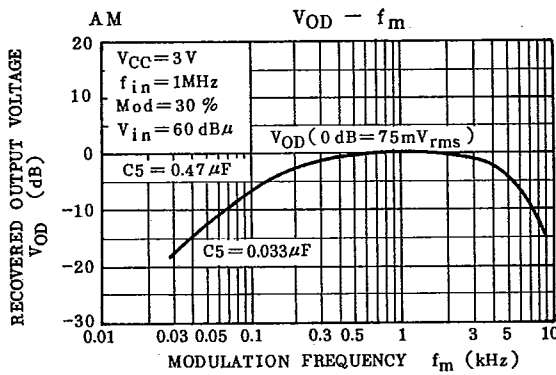
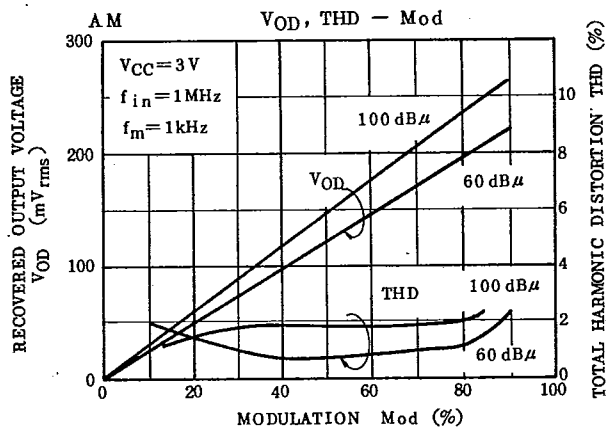
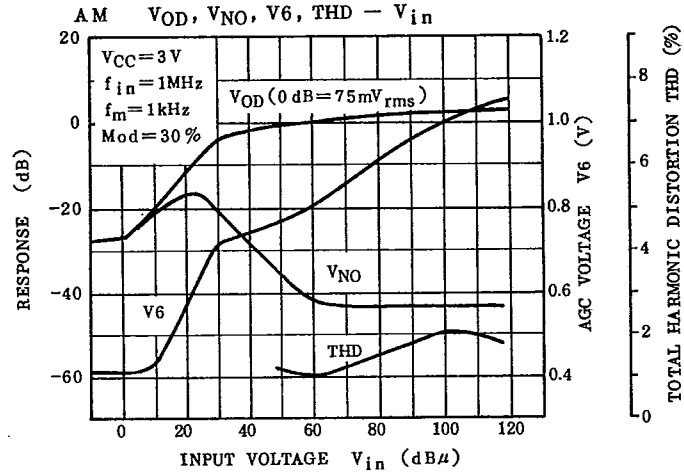

AUDIO LINEAR IC

**TA7787AP / AF**  
**TA8110AP / AF**

T-77-05-07

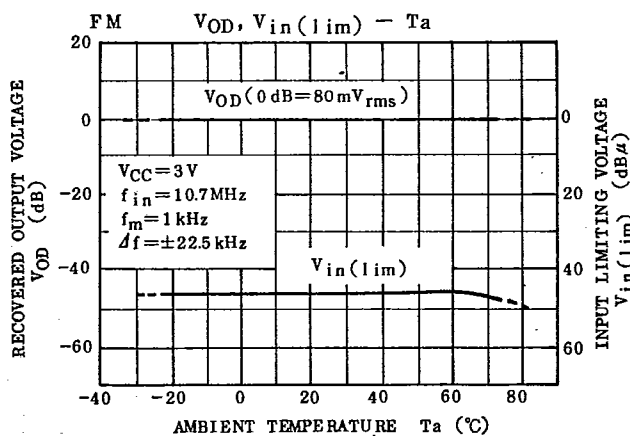
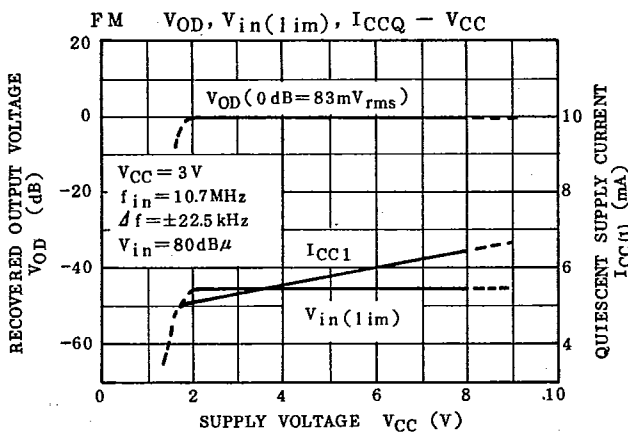
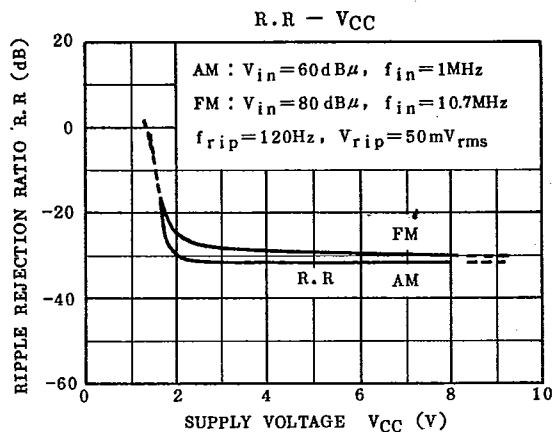

**TA7787AP / AF**  
**TA8110AP / AF**

T-77-05-07

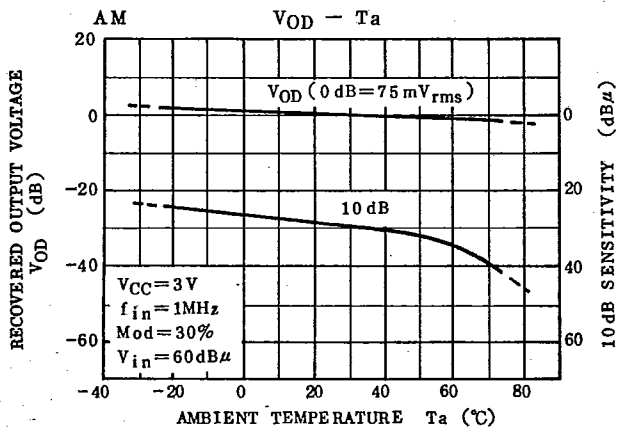
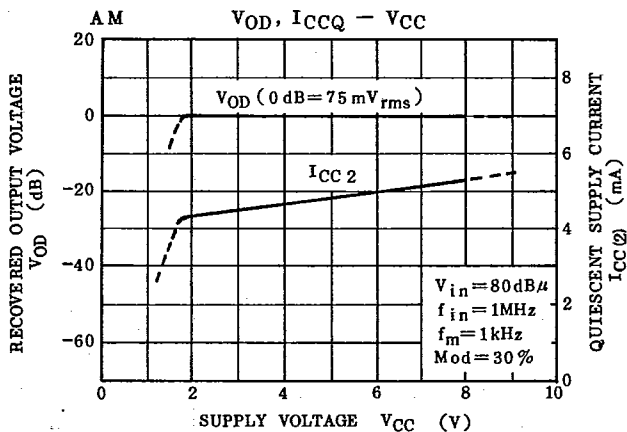
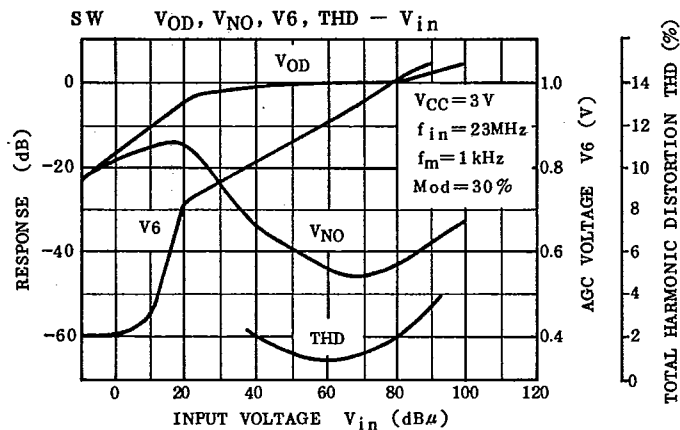

AUDIO LINEAR IC