

TA7769P

T-74-05-01

DUAL AUDIO POWER AMPLIFIER

TA7769P is dual audio power amplifier designed for the audio power amplifier of portable radio cassette tape recorder.

- High Output Power : $P_{OUT}=1.0W$ (Typ.)
($V_{CC}=6V$, $R_L=4\Omega$, $f=1kHz$, $THD=10\%$)
- Built-in Thermal Shut Down Protection Circuit
- Small Pop Noises at Power Supply ON
- Soft Clip
- Wide Operating Supply Voltage Range : $V_{CC}=4.5\sim 9.0V$

Unit in mm

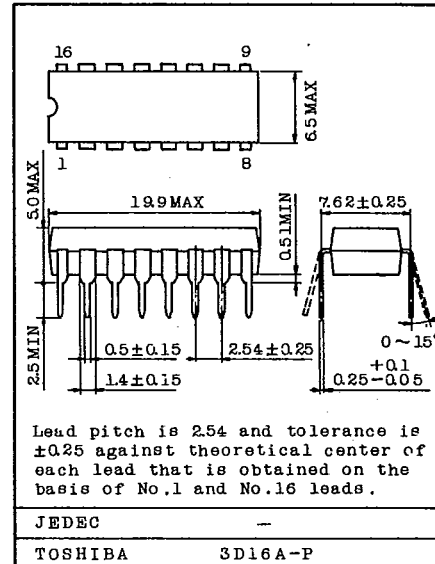

Lead pitch is 2.54 and tolerance is ± 0.25 against theoretical center of each lead that is obtained on the basis of No.1 and No.16 leads.

MAXIMUM RATINGS ($T_a=25^\circ C$)

CHARACTERISTIC	SYMBOL	RATING	UNIT
Supply Voltage	V_{CC}	14	V
Power Dissipation (Note 1) (Package Limitation)	P_D	3.6	W
Operating Temperature	T_{opr}	-25 ~ 75	$^\circ C$
Storage Temperature	T_{stg}	-55 ~ 150	$^\circ C$

Note 1 : Value for mounting on PC board with Cu Fin.
(Refer to P_D - T_a curve)

AUDIO LINEAR IC

9097247 TOSHIBA. ELECTRONIC

02E 17595 D

TA7769P

T-74-05-01

ELECTRICAL CHARACTERISTICS

(Unless otherwise specified, $V_{CC}=6V$, $R_L=4\Omega$, $R_g=600\Omega$, $f=1kHz$, $T_a=25^\circ C$)

CHARACTERISTIC	SYMBOL	TEST CIR-CUIT	TEST CONDITION	MIN.	TYP.	MAX.	UNIT
Quiescent Current	ICCQ	-	$V_{IN}=0$	-	30	55	mA
Output Power	POUT(1)	-	THD=10%	0.7	1.0	-	W
	POUT(2)		THD=10%, $R_L=3\Omega$	-	1.2	-	
	POUT(3)		THD=10%, $R_L=8\Omega$	-	0.62	-	
	POUT(4)		THD=10%, $V_{CC}=7.5V$ $R_L=8\Omega$	-	0.96	-	
Total Harmonic Distortion	THD	-	$P_{OUT}=0.25W$, $G_v=45dB$	-	0.15	1.0	%
Voltage Gain	$G_v(1)$	-	$R_f=82\Omega$, $V_{OUT}=0.775V_{rms}$	43	45	47	dB
	$G_v(2)$		$R_f=0$, $V_{OUT}=0.775V_{rms}$	-	56.5	-	
Cross Talk	C.T.	-	$V_{OUT}=0.775V_{rms}$	-	-60	-	dB
Ripple Rejection Ratio	R.R.	-	$V_{Rip}=245mV_{rms}$ $f_{Rip}=100Hz$	-	-55	-40	dB
Output Noise Voltage	V_{NO}	-	$R_g=10k\Omega$, $G_v=45dB$ $BW=20 \sim 20kHz$	-	0.4	0.7	mV_{rms}
Input Resistance	R_{IN}	-		-	30	-	$k\Omega$
Input Offset Voltage	V_7, V_{10}	-		-	30	-	mV

TYPICAL DC VOLTAGE OF EACH TERMINAL

($V_{CC}=6V$, $T_a=25^\circ C$ by Test Circuit)

TERMINAL No.	1	2	3	4	5	6	7	8	9	10	11	12	13	14	15	16
DC Voltage(V)	NC	3.0	5.75	0	0	0.65	0.03	5.95	0	0.03	0.65	0	0	5.75	3.0	6.0

TA7769P

T-74-05-01

TEST CIRCUIT & BLOCK DIAGRAM

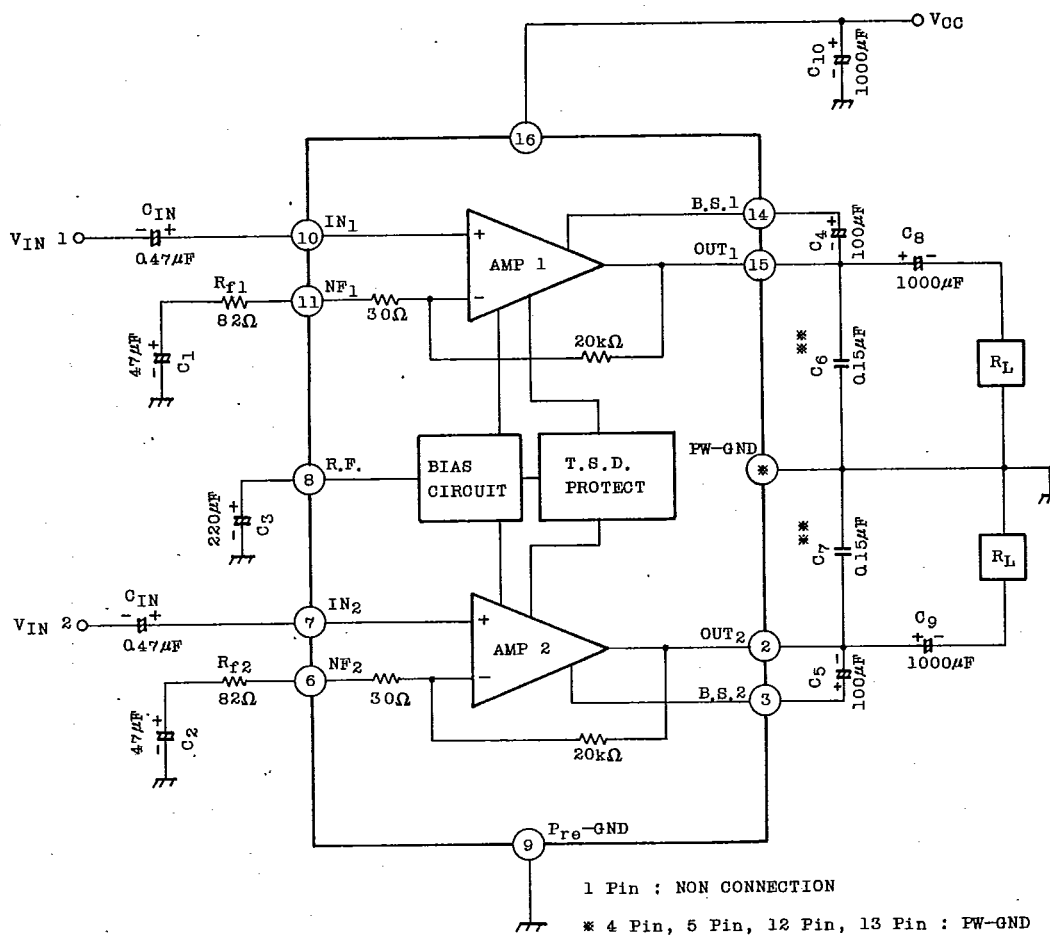

** For C₆ and C₇, it is advised to use polyester film capacitor having superior quality in the characteristics of high frequency and temperature.

AUDIO LINEAR IC

TA7769P

T-74-05-01

PRECAUTIONS FOR USE AND APPLICATION

1) Input Stage

The input stage of power amplifier is comprised of a PNP differential pair preceded by a PNP emitter follower which allows DC referencing of the source signal to ground. This eliminates the need for an input coupling capacitor. However, in case the brush noise of volume becomes a problem, provide serially a coupling capacitor to the input side.

2) Adjustment of Voltage Gain

The voltage gain is fixed at $G_v=56.5\text{dB}$ by the resistors (R_1 and R_2) in IC, however, its reduction is possible through adding R_f as shown in Figure 1. In this case, the voltage gain is obtained by the following equation.

$$G_v = 20\log \frac{R_1+R_2+R_f}{R_1+R_2}$$

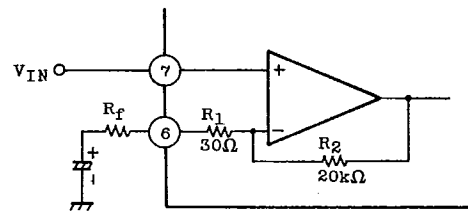

Figure 1

It is recommended to use this IC with the voltage gain of $G_v=40\text{dB}$ or over.

3) Measures Against Oscillation

For the capacitors C_6 and C_7 to be applied for preventing the oscillation between output terminal and GND, use the polyester film capacitor having superior quality in high frequency and temperature characteristics, however, since the characteristics of the capacitor may be different depending on the manufactures or kinds, apply the capacitor after confirmation.

Since the characteristics of the capacitor of the ceramic type are liable to be affected by the temperature and the voltage, use the capacitor of larger capacity and be sure to perform the thermal test to check the oscillation allowance.

TA7769P

T-74-05-01

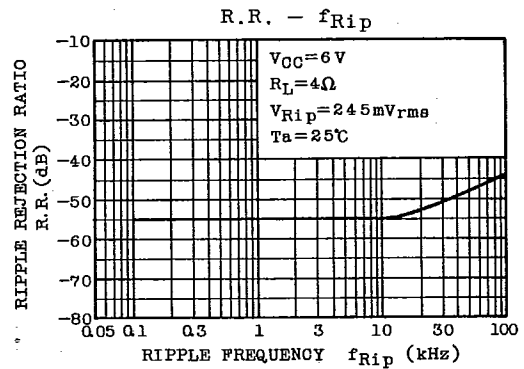
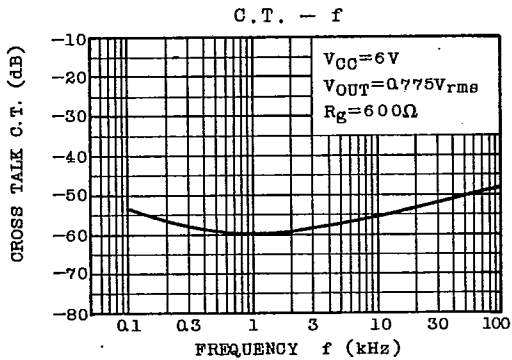
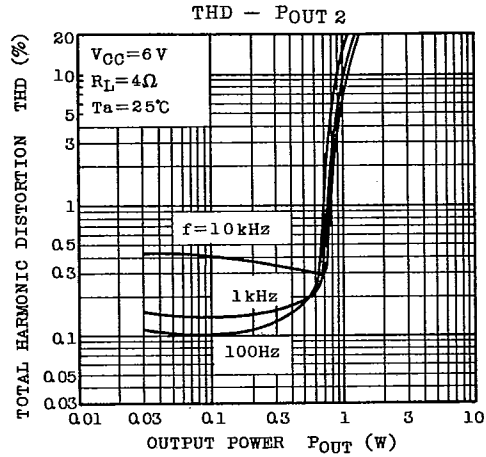
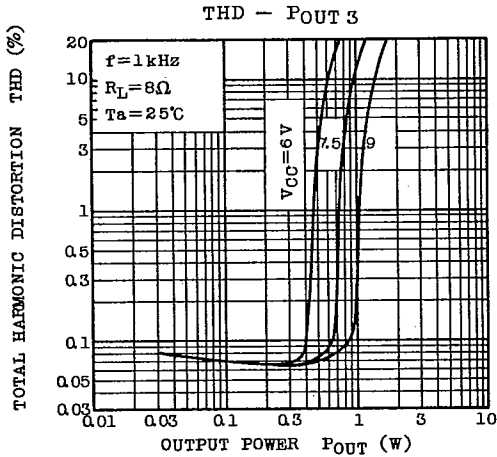
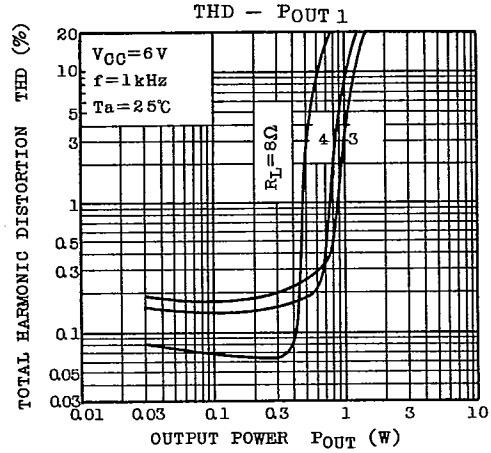
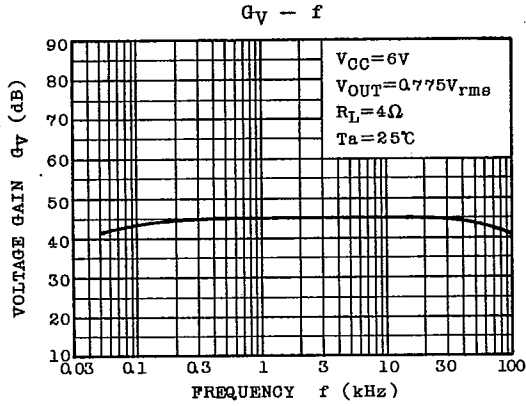

AUDIO LINER IC

TA7769P

T-74-05-01

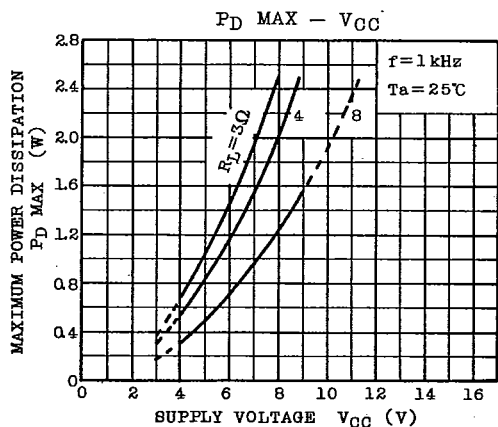
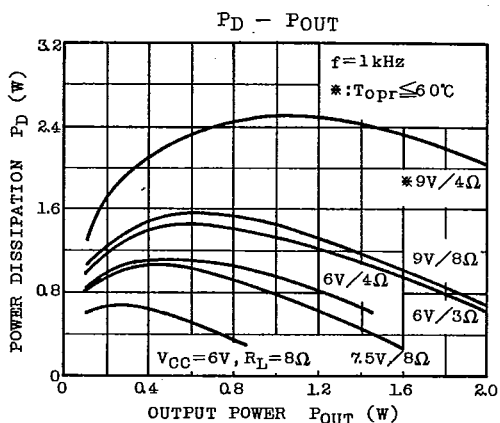
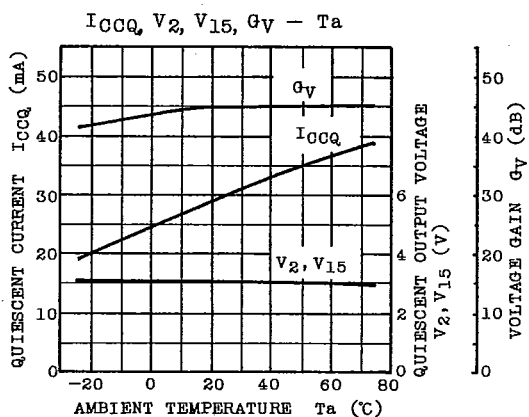
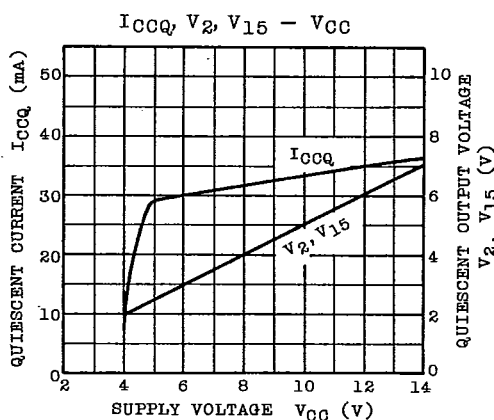
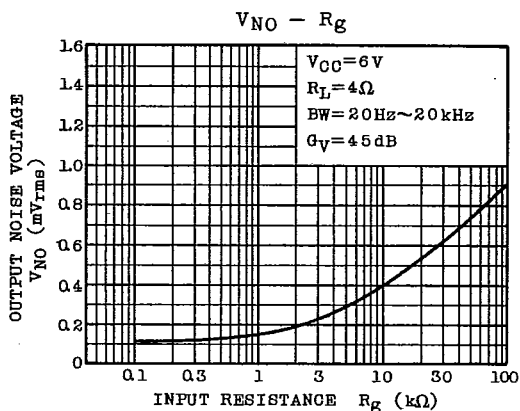

TA7769P

T-74-05-01

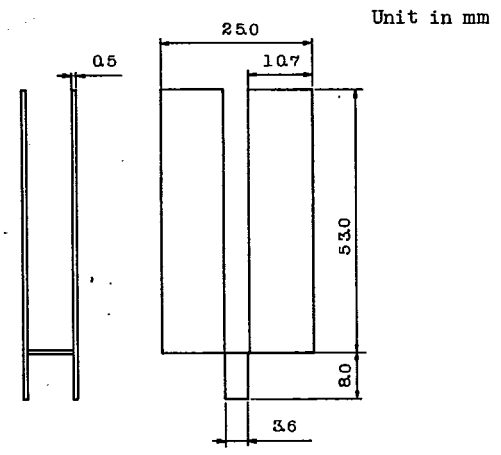
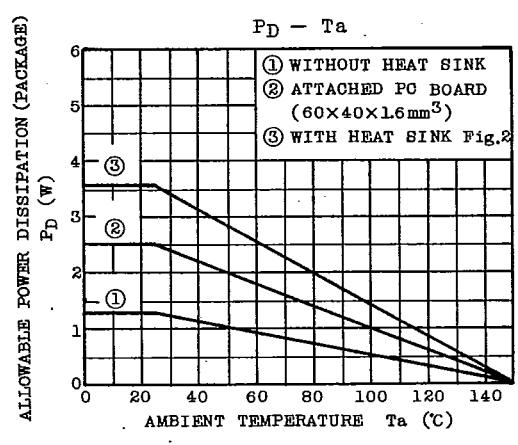

Figure 2

AUDIO LINEAR IC