

TA4013F

UHF WIDE BAND AMPLIFIER APPLICATIONS

FEATURES

- High Power : $P_{o1dB} = 3dBmW$
- Wide Band : $f = 1.7GHz$ (3dB down)
- Operating Supply Voltage : $V_{CC} = 1.5\sim 3V$

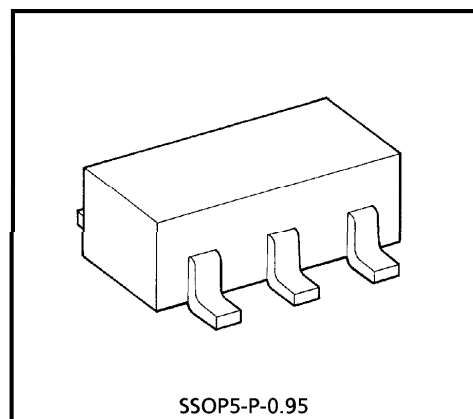

SSOP5-P-0.95

Weight : 0.014g (Typ.)

MAXIMUM RATINGS (Ta = 25°C)

CHARACTERISTIC	SYMBOL	RATING	UNIT
Supply Voltage	V_{CC}	4	V
Total Power Dissipation	P_D (Note 1)	300	mW
Operating Temperature	T_{opr}	-40~85	°C
Storage Temperature	T_{stg}	-55~150	°C

(Note 1) When mounted on the glass epoxy of 2.5cm² × 1.6t

PIN ASSIGNMENT

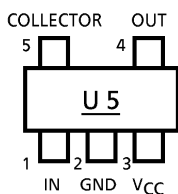

CAUTION

This device electrostatic sensitivity. Please handle with caution.

980508EBA1

- TOSHIBA is continually working to improve the quality and the reliability of its products. Nevertheless, semiconductor devices in general can malfunction or fail due to their inherent electrical sensitivity and vulnerability to physical stress. It is the responsibility of the buyer, when utilizing TOSHIBA products, to observe standards of safety, and to avoid situations in which a malfunction or failure of a TOSHIBA product could cause loss of human life, bodily injury or damage to property. In developing your designs, please ensure that TOSHIBA products are used within specified operating ranges as set forth in the most recent products specifications. Also, please keep in mind the precautions and conditions set forth in the TOSHIBA Semiconductor Reliability Handbook.
- The products described in this document are subject to foreign exchange and foreign trade laws.
- The information contained herein is presented only as a guide for the applications of our products. No responsibility is assumed by TOSHIBA CORPORATION for any infringements of intellectual property or other rights of the third parties which may result from its use. No license is granted by implication or otherwise under any intellectual property or other rights of TOSHIBA CORPORATION or others.
- The information contained herein is subject to change without notice.

ELECTRICAL CHARACTERISTICS (Ta = 25°C, Zg = Zl = 50Ω)

CHARACTERISTIC	SYMBOL	TEST CONDITION	MIN.	TYP.	MAX.	UNIT
Circuit Current	I _{CC}	V _{CC} = 2V, Non carrier	7	10.5	14	mA
Band Width	BW	V _{CC} = 2V (Note 2)	1.5	1.7	—	GHz
Insertion Gain	S ₂₁ ²	V _{CC} = 2V, f = 1GHz	12	14	—	dB
Noise Figure	NF	V _{CC} = 2V, f = 1GHz	—	4.5	6	dB
Isolation	S ₁₂ ²	V _{CC} = 2V, f = 1GHz	—	-26	—	dB
Input Return Loss	S ₁₁ ²	V _{CC} = 2V, f = 1GHz	—	-5.5	—	dB
Output Return Loss	S ₂₂ ²	V _{CC} = 2V, f = 1GHz	—	-15	—	dB
Output Power at 1dB Gain Compression	Po1dB	V _{CC} = 2V, f = 1GHz	—	3	—	dBmW

(Note 2) BW is the frequency of 3dB down from |S₂₁|² at 1GHz.

RF TEST CIRCUIT (TOP VIEW)

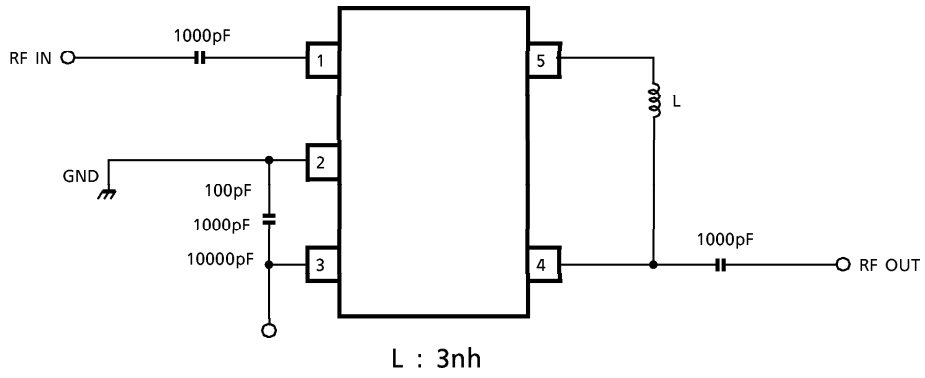

EQUIVALENT CIRCUIT

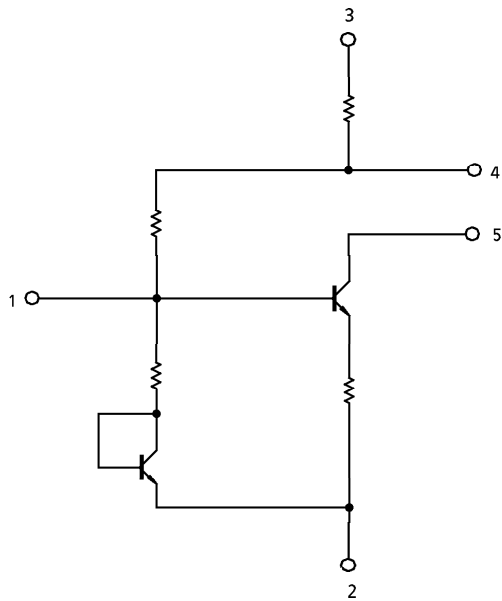

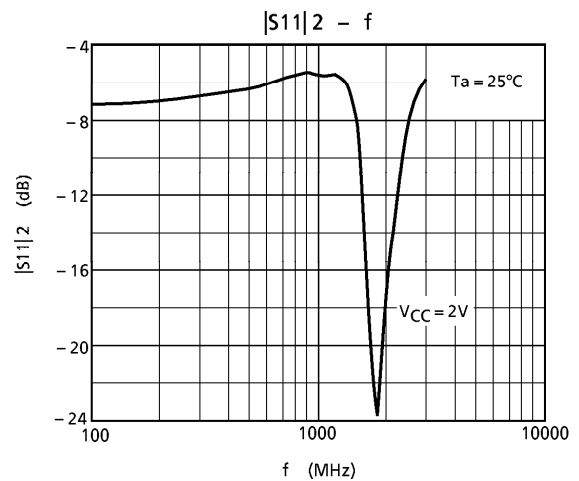
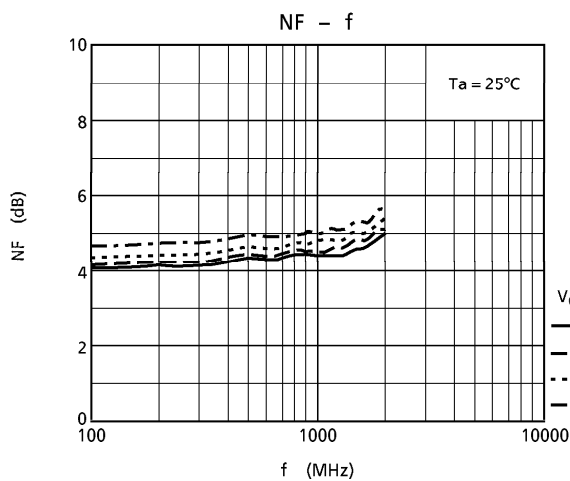
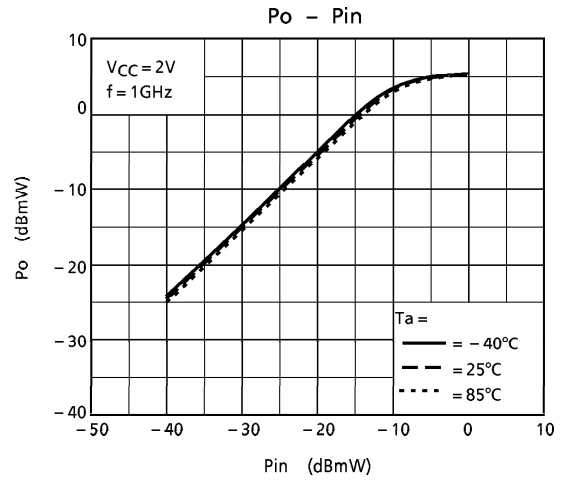
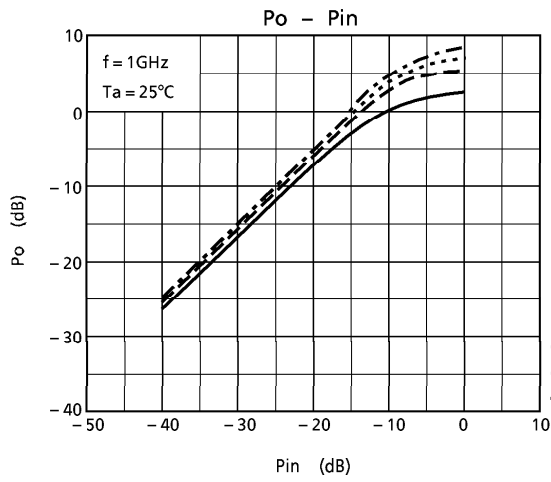
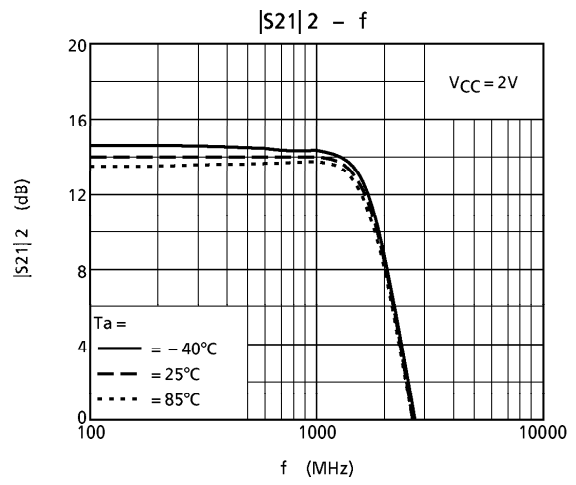
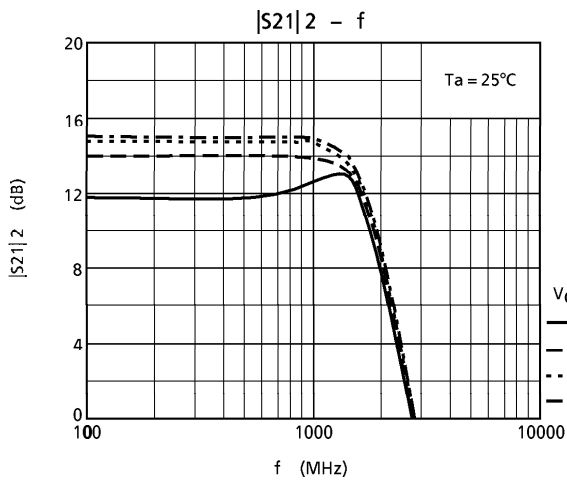

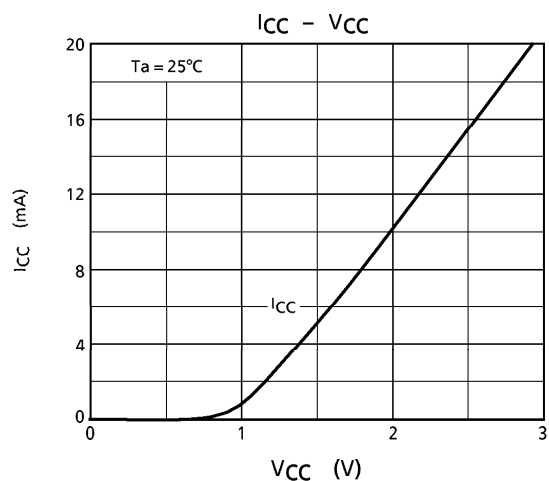
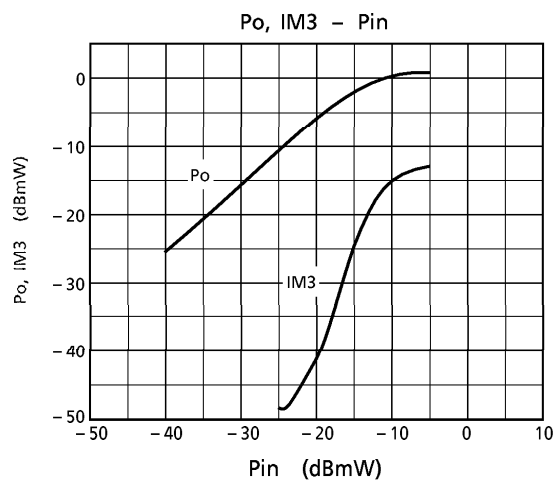
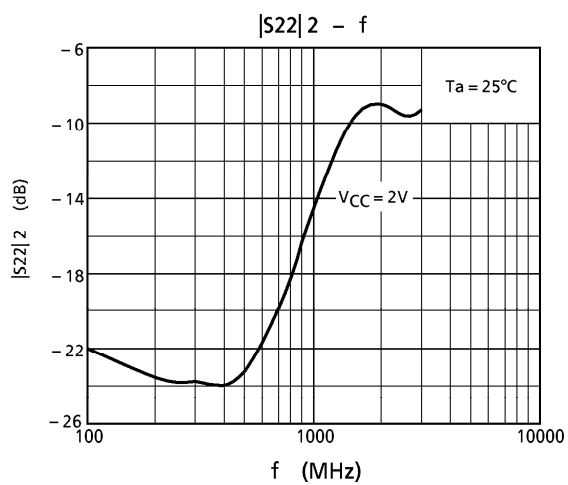
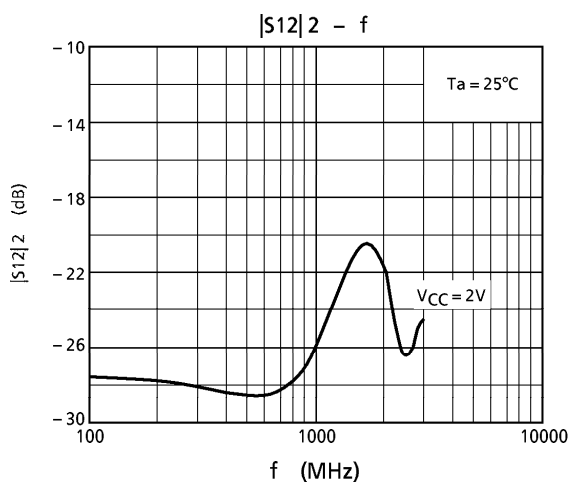

OUTLINE DRAWING
SSOP5-P-0.95

Unit : mm

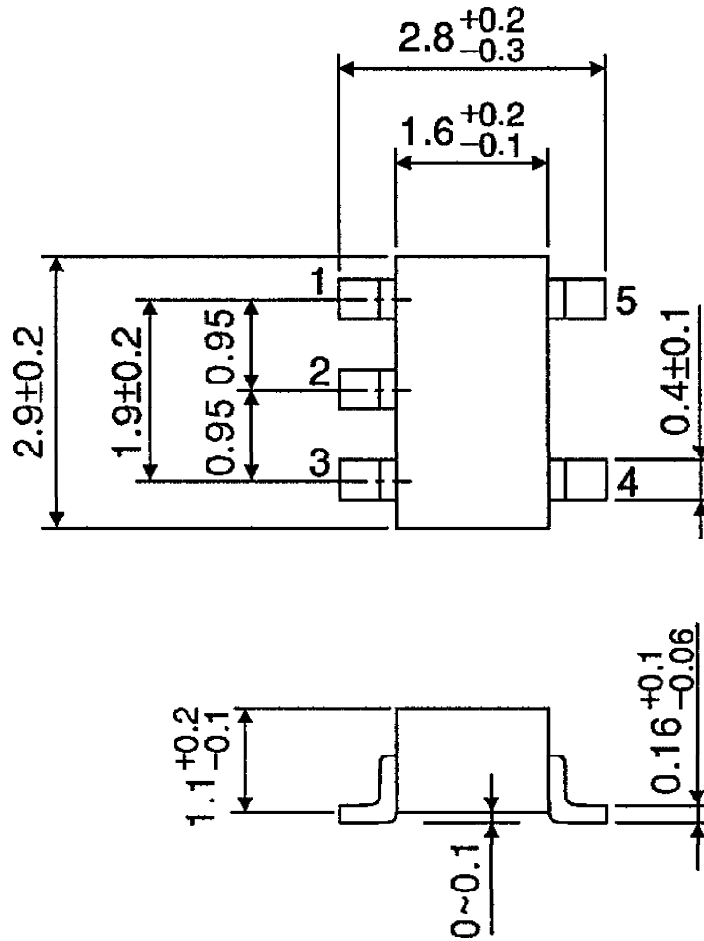

Weight : 0.014g (Typ.)