

TA2145AFG

3 V Stereo Headphone Amplifier (3 V USE)

The TA2145AFG is developed for play-back stereo headphone equipments (3 V USE).

It is built in dual preamplifiers, dual OCL power amplifiers, motor governor, DC volume control and preamplifier on/off switch etc.

Features

- Built-in preamplifier
 - Input coupling condenser-less
 - Built-in input capacitor for reducing buzz noise
 - Low noise: $V_{ni} = 1.2 \mu\text{Vrms}$ (typ.)
 - Preamplifier on/off switch.
- Built-in power amplifier
 - OCL (Output condenser-less)
 - Voltage gain: $G_V = 31 \text{ dB}$ (typ.)
- Built-in motor governor (Current proportion type)
- Built-in DC volume control function
 - $ATT = 82\text{dB}$ ($T_a = 25^\circ\text{C}$, typ.)
- Built-in bass boost function
- Low supply current ($V_{CC} = 3 \text{ V}$, $f = 1 \text{ kHz}$, $\text{PRE OUT} = 100 \text{ mVrms}$, $T_a = 25^\circ\text{C}$, typ.)
 - Quiescent supply current
 - PRE + PW: $I_{CCQ} = 8.5 \text{ mA}$
 - GVN: $I_{CC} = 2.5 \text{ mA}$
 - $0.1 \text{ mW} \times 2 \text{ ch}$ output
 - $I_{CC1} = 9.8 \text{ mA}$ ($R_L = 32 \Omega$)
 - $I_{CC2} = 10.5 \text{ mA}$ ($R_L = 16 \Omega$)
 - $0.5 \text{ mW} \times 2 \text{ ch}$ output
 - $I_{CC3} = 14.0 \text{ mA}$ ($R_L = 32 \Omega$)
 - $I_{CC4} = 16.5 \text{ mA}$ ($R_L = 16 \Omega$)
- Operating supply voltage range ($T_a = 25^\circ\text{C}$)
 - $V_{CC(\text{opr})} = 1.8 \sim 3.6 \text{ V}$
 - GVN $V_{CC(\text{opr})} = 2.1 \sim 3.6 \text{ V}$ (Motor voltage = 1.8 V)

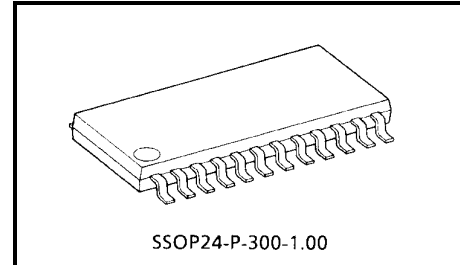

Weight: 0.32 g (typ.)

Block Diagram

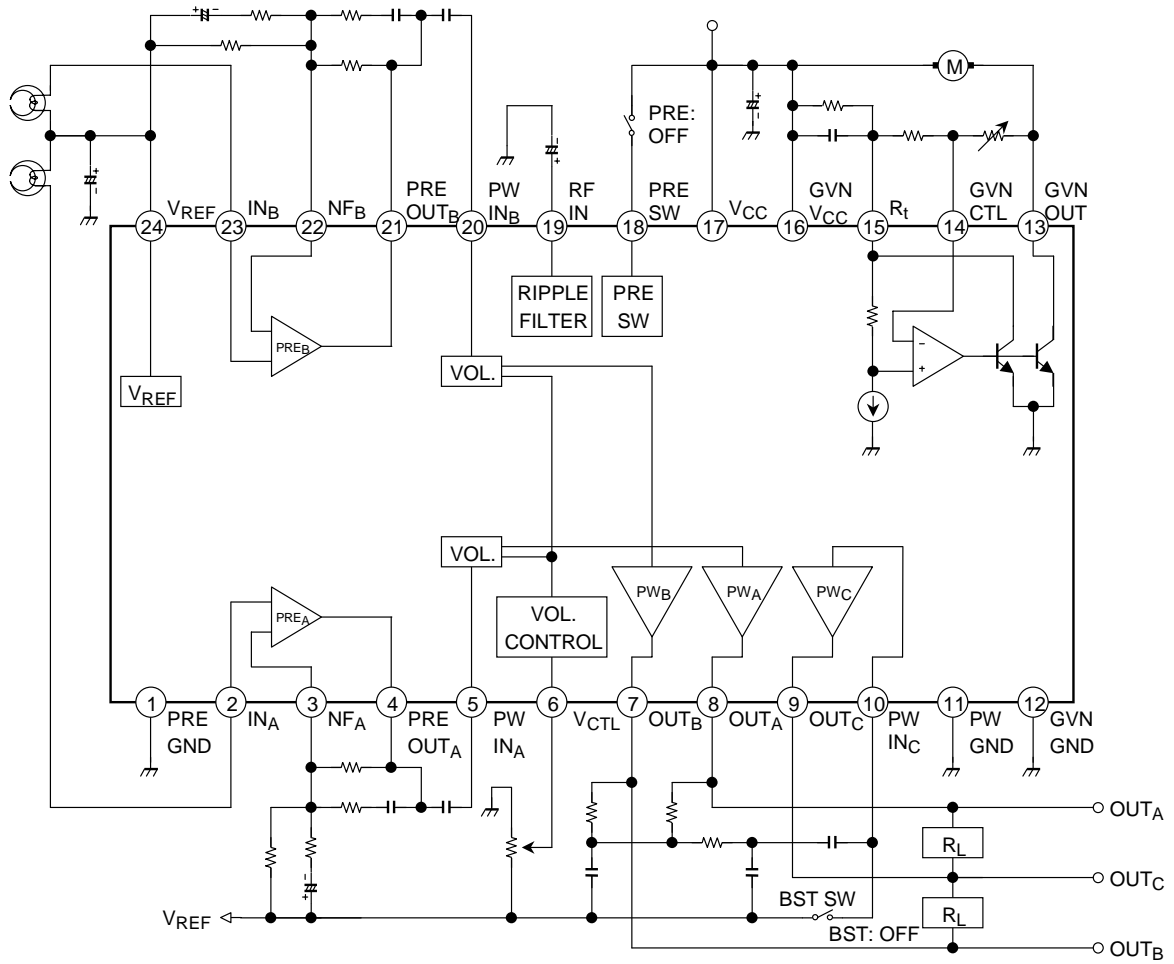

Terminal Explanation (Terminal Voltage: Typical terminal voltage at no signal with test circuit, $V_{CC} = 3\text{ V}$, $T_a = 25^\circ\text{C}$)

Terminal		Function	Internal Circuit	Terminal Voltage (v)
No.	Name			
1	PRE GND	The GND, except for power drive stage and motor governer stage.	—	0
2	IN _A	Input of preamplifier		1.2
23	IN _B			1.2
3	NF _A			NF of preamplifier
22	NF _B			
4	PRE OUT _A	Output of preamplifier		1.2
21	PRE OUT _B			
7	OUT _B	Output of power amplifier		
8	OUT _A			
9	OUT _C			
5	PW IN _A	Input of power amplifier		1.2
20	PW IN _B			
6	V _{CTL}	The terminal of DC volume control		—

Terminal		Function	Internal Circuit	Terminal Voltage (v)
No.	Name			
10	PW IN _C	Input of center amplifier		1.2
11	PW GND	GND for power drive stage	—	0
12	GVN GND	GND for motor governor stage	—	0
13	GVN OUT	Motor terminal		—
14	GVN CTL	The terminal of motor speed control		—
15	R _t	The terminal of amateur compensation resistor		—
16	GVN V _{CC}	V _{CC} for motor governor stage		3
17	V _{CC}	V _{CC} for preamplifier stage and power amplifier stage.	—	3
18	PRE SW	Muting switch of preamplifier [Preamp. on: "L" level/open Preamp. off: "H" level Refer to application note		—

Terminal		Function	Internal Circuit	Terminal Voltage (v)
No.	Name			
19	RF IN	Ripple filter of power supply		2.5
24	V _{REF}	Reference voltage Preamplifier and power amplifier operate on this reference.		1.2

Application Note

- VCC and GND

This IC has two VCC terminals and three GND terminals. Pattern layout should be designed carefully to reduce the common impedance.

 - VCC

VCC (pin 17) ----- Preamplifier stage and power amplifier stage.
 GVN VCC (pin 16) ----- Motor governor stage.
 - GND

PRE GND (pin 1) ----- Preamplifier stage, and power amplifier stage except for the power drive stage.
 PW GND (pin 11) ----- Power drive stage of power amplifier.
 GVN GND (pin 12) ----- Motor governor stage.
- VREF

It is necessary to stabilize the VREF circuit, because the internal circuit operate on this reference.
- RF IN

As this terminal is an input terminal of the ripple filter, it cannot supply a power supply to other ICs etc.
- Preamplifier

Input signal should be applied to VREF standard, otherwise pop noise become bigger when VCC is turned on and off.
- Power amplifier

It is necessary to insert the coupling capacitor through the PW IN terminal. In case that DC current or DC voltage is applied to the PW IN terminal, the internal circuit has unbalance and the power amplifier doesn't operate normally.
- Operating supply voltage range of motor governor stage

As for the minimum of operating supply voltage range, the motor voltage is 1.8 V.
 In case that it is more than 1.8 V, the low voltage performance becomes bad.
- PRE SW sensitivity (Ta = 25°C)

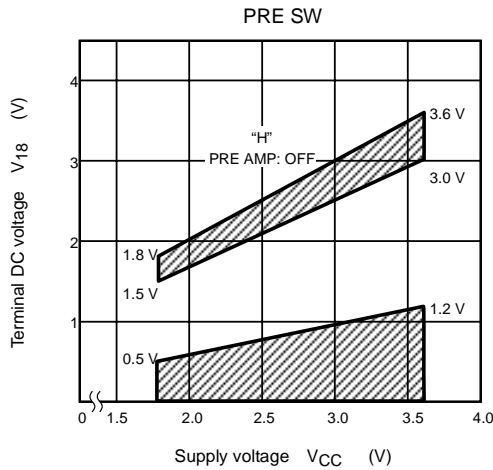

Absolute Maximum Ratings (Ta = 25°C)

Characteristic	Symbol	Rating	Unit
Supply voltage	V _{CC}	4	V
Power dissipation	P _D	(Note 1)	400
		(Note 2)	925
Output current (PW AMP.)	I _O (PW)	200	mA
Output current (GVN)	I _O (GVN)	700	mA
Operating temperature	T _{opr}	-25~75	°C
Storage temperature	T _{stg}	-55~150	°C

Note 1: IC only: Derated above Ta = 25°C in the proportion 3.2 mW/°C

Note 2: IC + PCB (TOSHIBA typical PCB): Derated above Ta = 25°C in the proportion 7.4 mW/°C

Electrical Characteristics

(Unless otherwise specified, $V_{CC} = 3\text{ V}$, $T_a = 25^\circ\text{C}$, $f = 1\text{ kHz}$, SW2: a, SW5: OPEN

Preamplifier: $R_g = 2.2\text{ k}\Omega$, $R_L = 10\text{ k}\Omega$, SW1: ON, SW3: b, SW4: b

Power amplifier: $R_g = 600\ \Omega$, $R_L = 16\ \Omega$, Vol.: max, SW1: OPEN, SW3: a, SW4: a

Motor governor: $I_m = 100\text{ mA}$, SW1: OPEN, SW3: b, SW4: b)

	Characteristic	Symbol	Test circuit	Test condition	Min	Typ.	Max	Unit
	Quiescent supply current	I_{CCQ1}	—	Pre off, $V_{in} = 0$, Vol.: min, SW4: b, SW5: ON	—	7.5	13	mA
		I_{CCQ2}	—	$V_{in} = 0$, Vol.: min, SW4: b	—	8.5	14.5	
Pre amp.	Open loop voltage gain	G_{VO}	—	$V_o = -10\text{dBV}$, SW2: b	—	86	—	dB
	Closed loop voltage gain	G_{VC}	—	$V_o = -10\text{dBV}$	—	35	—	dB
	Maximum output voltage	V_{om}	—	THD = 1%	550	720	—	mVrms
	Total harmonic distortion	THD1	—	$V_o = -10\text{dBV}$	—	0.02	0.3	%
	Equivalent input noise voltage	V_{ni}	—	$R_g = 2.2\text{ k}\Omega$, SW1: OPEN BPF = 20 Hz~20 kHz, NAB ($G_V = 35\text{dB}$, $f = 1\text{ kHz}$)	—	1.2	2.4	μVrms
	Cross talk	CT1	—	$V_o = -10\text{dBV}$	—	70	—	dB
	Ripple rejection ratio	RR1	—	$f_r = 100\text{ Hz}$, $V_r = -20\text{dBV}$	—	48	—	dB
	Preamplifier muting attenuation	ATT1	—	$V_o = -10\text{dBV}$, SW5: OPEN → ON	—	80	—	dB
	Preamplifier on voltage	$V_{18}\text{ (ON)}$	—	$V_{CC} = 1.8\text{ V}$	0	—	0.5	V
	Preamplifier off voltage	$V_{18}\text{ (OFF)}$	—		1.5	—	1.8	V
Power amp.	Voltage gain	G_V	—	$V_o = -10\text{dBV}$	29	31	33	dB
	Channel balance	CB	—	$V_o = -10\text{dBV}$	-1.5	0	+1.5	dB
	Output power 1	P_{o1}	—	$R_L = 16\ \Omega$, THD = 10%	17	28	—	mW
	Output power 2	P_{o2}	—	$R_L = 32\ \Omega$, THD = 10%	—	20	—	mW
	Total harmonic distortion	THD2	—	$P_o = 1\text{ mW}$	—	0.5	—	%
	Output noise voltage	V_{no}	—	$R_g = 600\ \Omega$, SW3: b BPF = 20 Hz~20 kHz	—	270	400	μVrms
	Ripple rejection ratio	RR2	—	$f_r = 100\text{ Hz}$, $V_r = -20\text{dBV}$	—	52	—	dB
	Cross talk	CT2	—	$V_o = -10\text{dBV}$	—	32	—	dB
Dc volume maximum attenuation	ATT2	—	$V_o = -10\text{dBV}$, SW4: a→b (Vol.: max → min)	—	82	—	dB	
Motor governor	Supply current	I_{CC}	—	$I_m = 0$	—	2.5	3.5	mA
	Saturation voltage	$V_{CE}\text{ (sat)}$	—	$I_m = 200\text{ mA}$	—	—	0.5	V
	Reference voltage	ΔV_{REF}	—	$I_m = 100\text{ mA}$	0.76	0.81	0.86	V
	Reference voltage fluctuation 1	ΔV_{REF1}	—	$V_{CC} = 2.1\text{--}3.6\text{ V}$	—	0.25	—	%/V
	Reference voltage fluctuation 2	ΔV_{REF2}	—	$I_m = 25\text{--}250\text{ mA}$	—	0.003	—	%/mA
	Reference voltage fluctuation 3	ΔV_{REF3}	—	$T_a = -25\text{--}75^\circ\text{C}$	—	0.005	—	%/°C
	Current ratio	K	—	—	34.5	37.5	40.5	
	Current ratio fluctuation 1	$\Delta K1$	—	$V_{CC} = 2.1\text{--}3.6\text{ V}$	—	0.25	—	%/V
	Current ratio fluctuation 2	$\Delta K2$	—	$I_m = 25\text{--}250\text{ mA}$	—	0.08	—	%/mA
	Current ratio fluctuation 3	$\Delta K3$	—	$T_a = -25\text{--}75^\circ\text{C}$	—	0.005	—	%/°C

Test Circuit

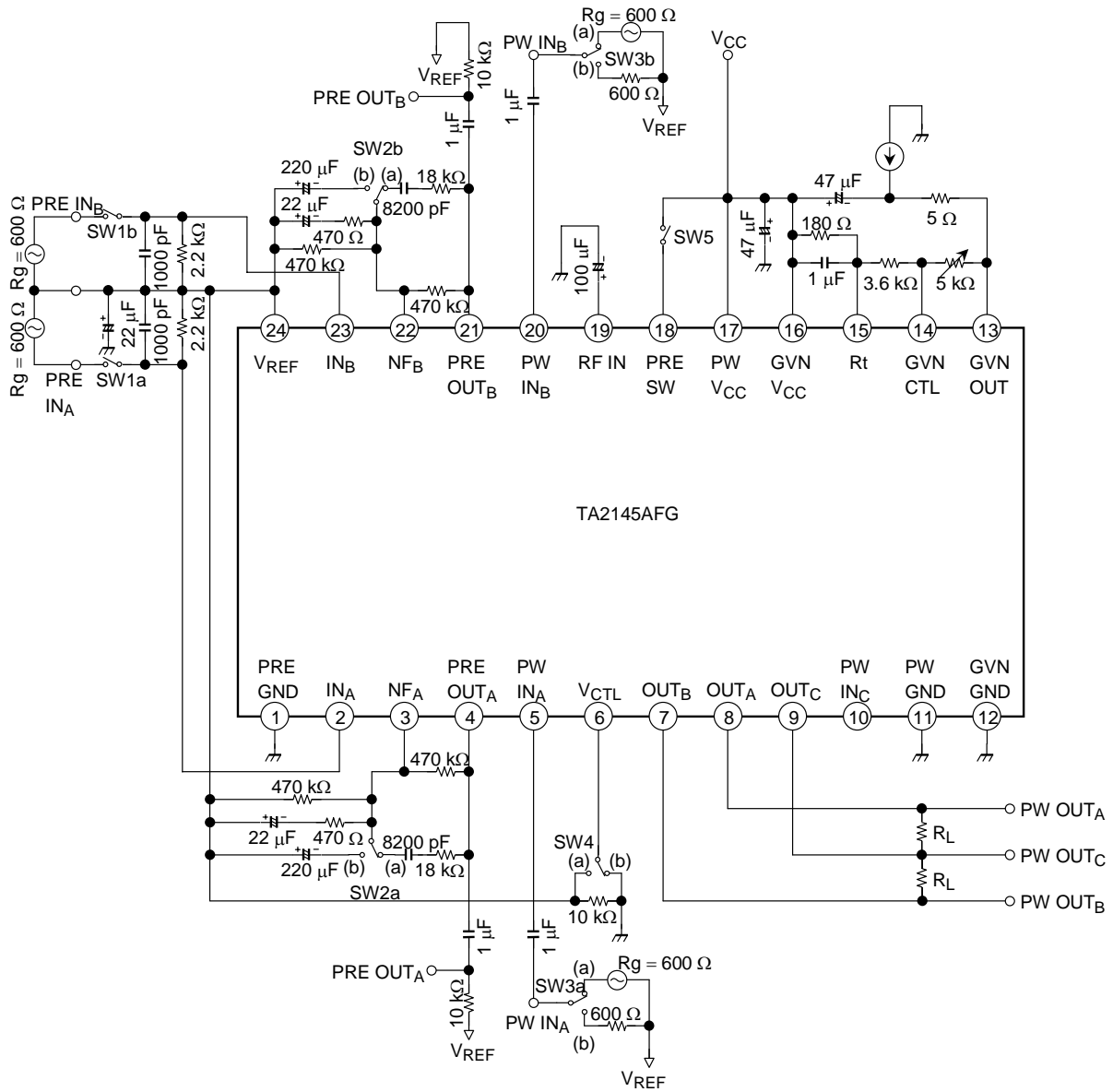

Characteristic Curves (Unless otherwise specified, $V_{CC} = 3\text{ V}$, $T_a = 25^\circ\text{C}$, $f = 1\text{ kHz}$,
Preamplifier: $R_g = 2.2\text{ k}\Omega$, $R_L = 10\text{ k}\Omega$
Power amplifier: $R_g = 600\ \Omega$, $R_L = 16\ \Omega$, $\text{Vol.} = \text{max}$
Motor governor: $I_m = 100\text{ mA}$)

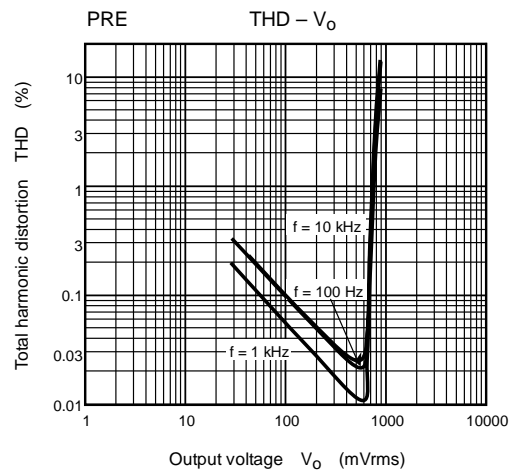
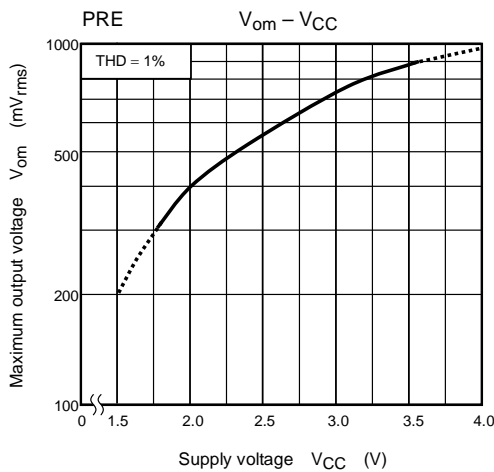
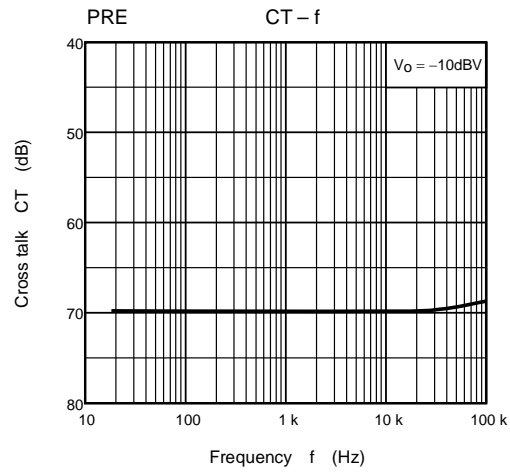
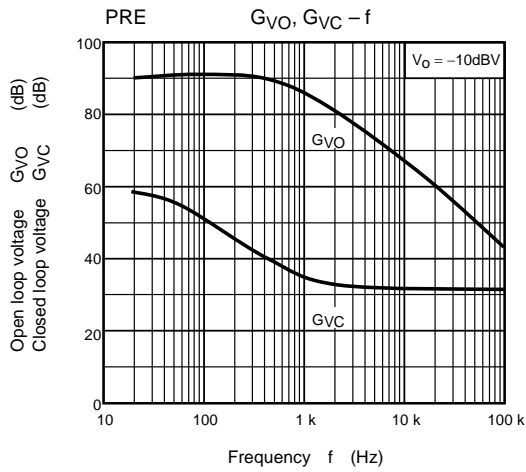
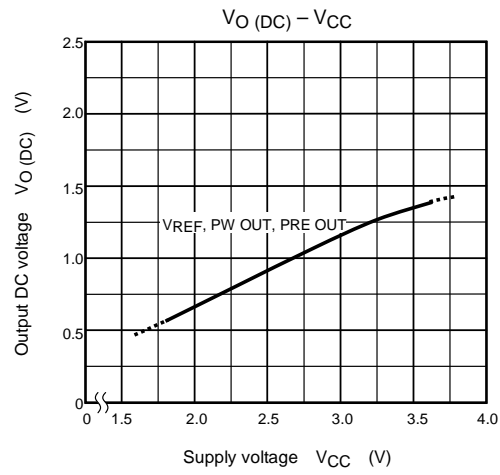
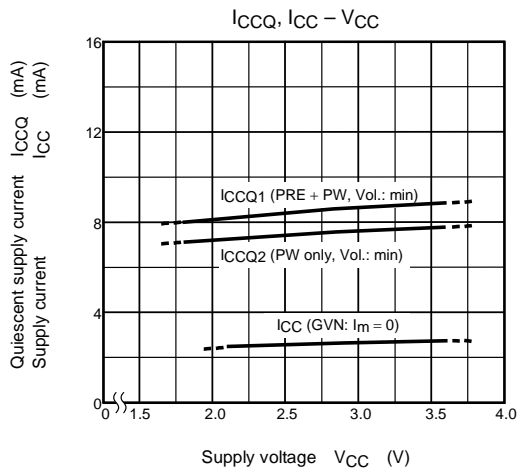

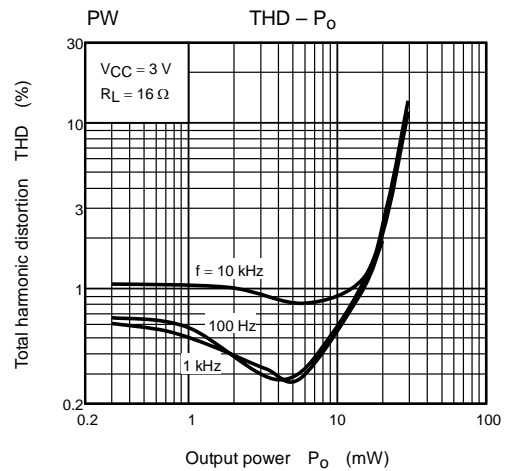
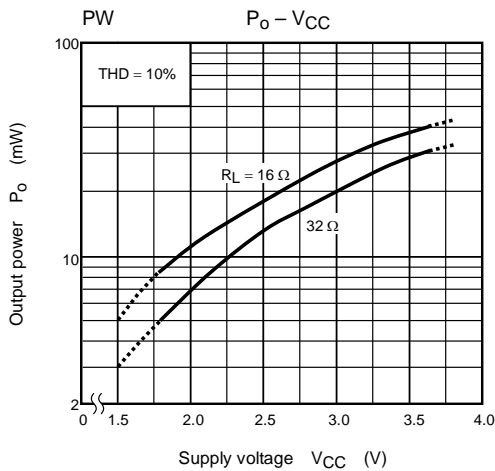
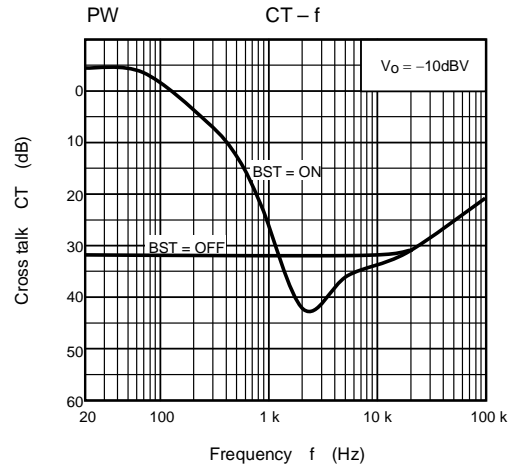
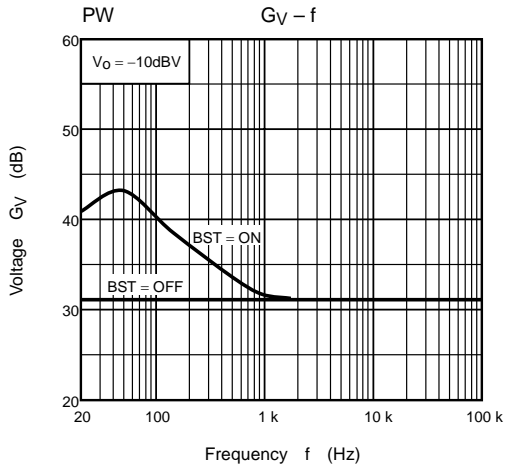
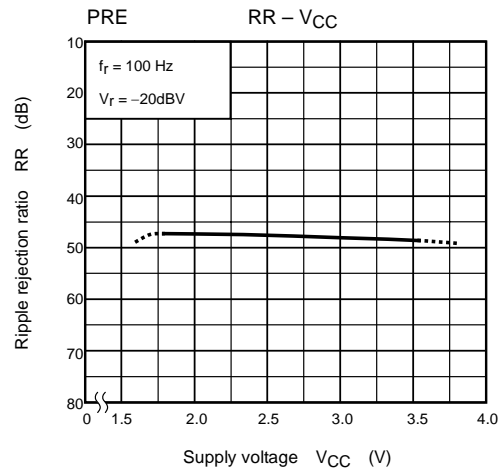
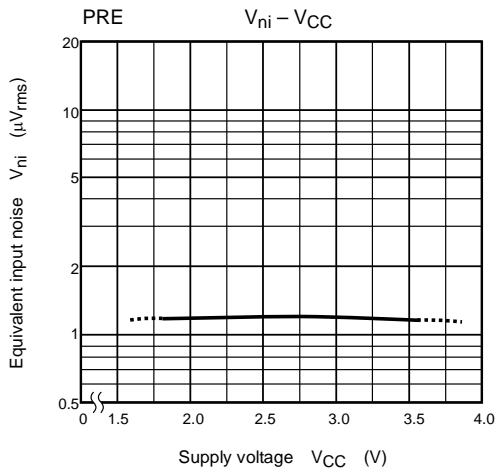

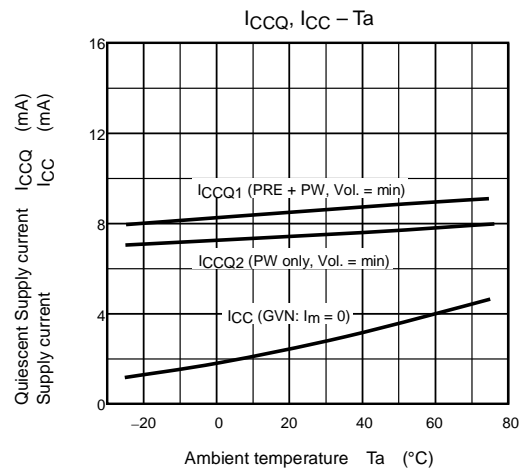
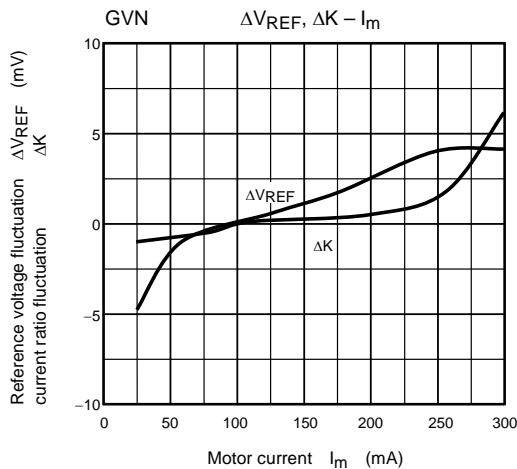
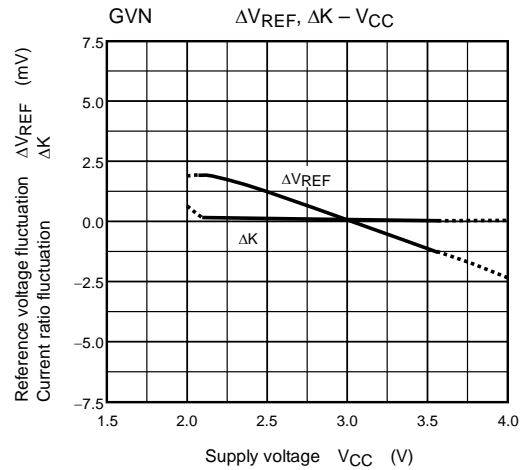
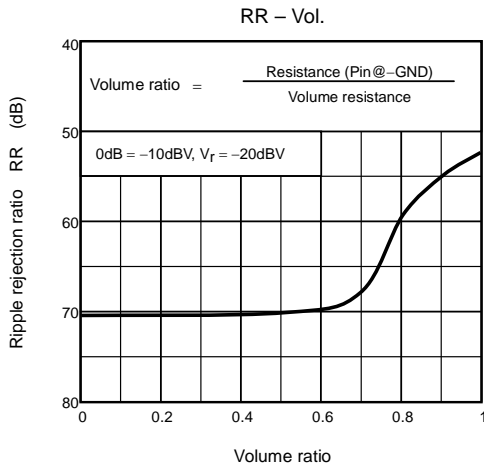
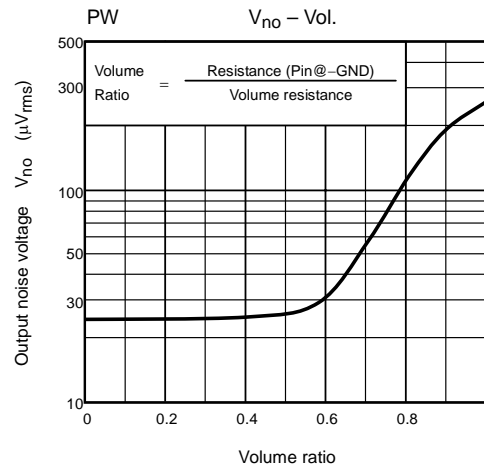
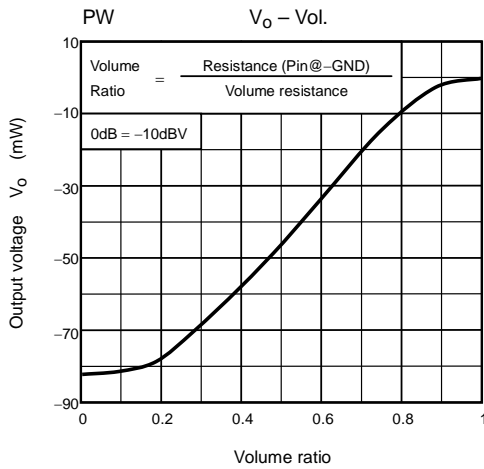

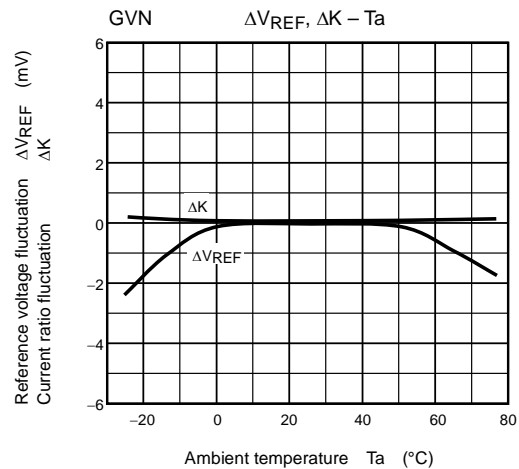
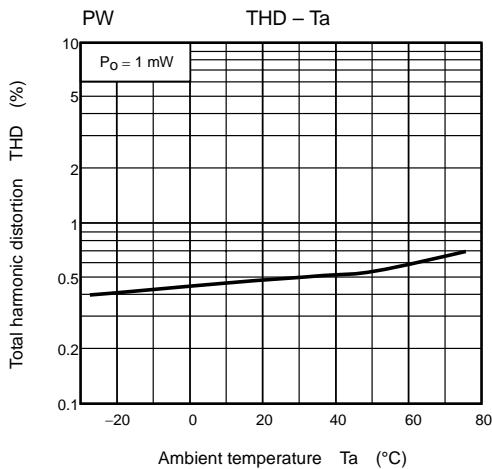
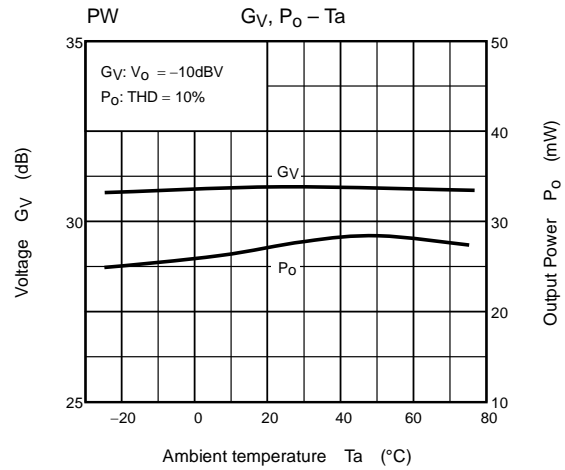
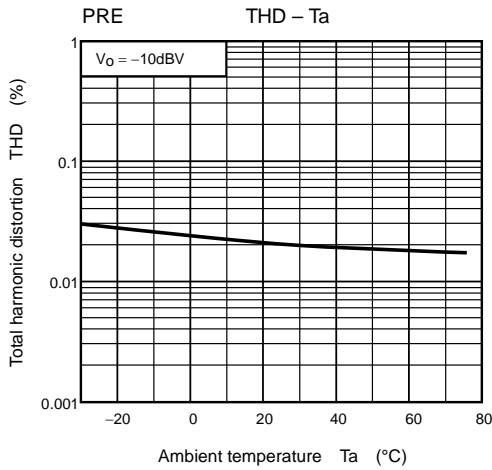
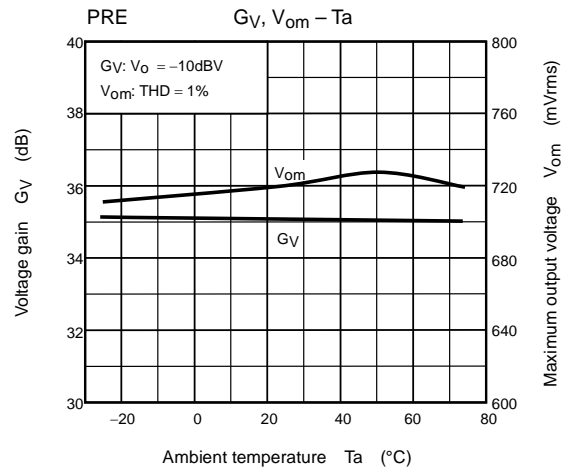
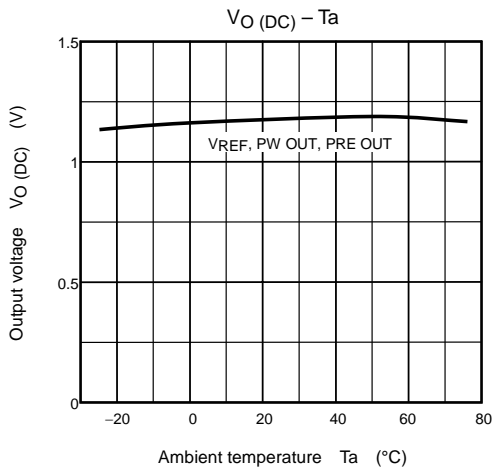

Application Circuit

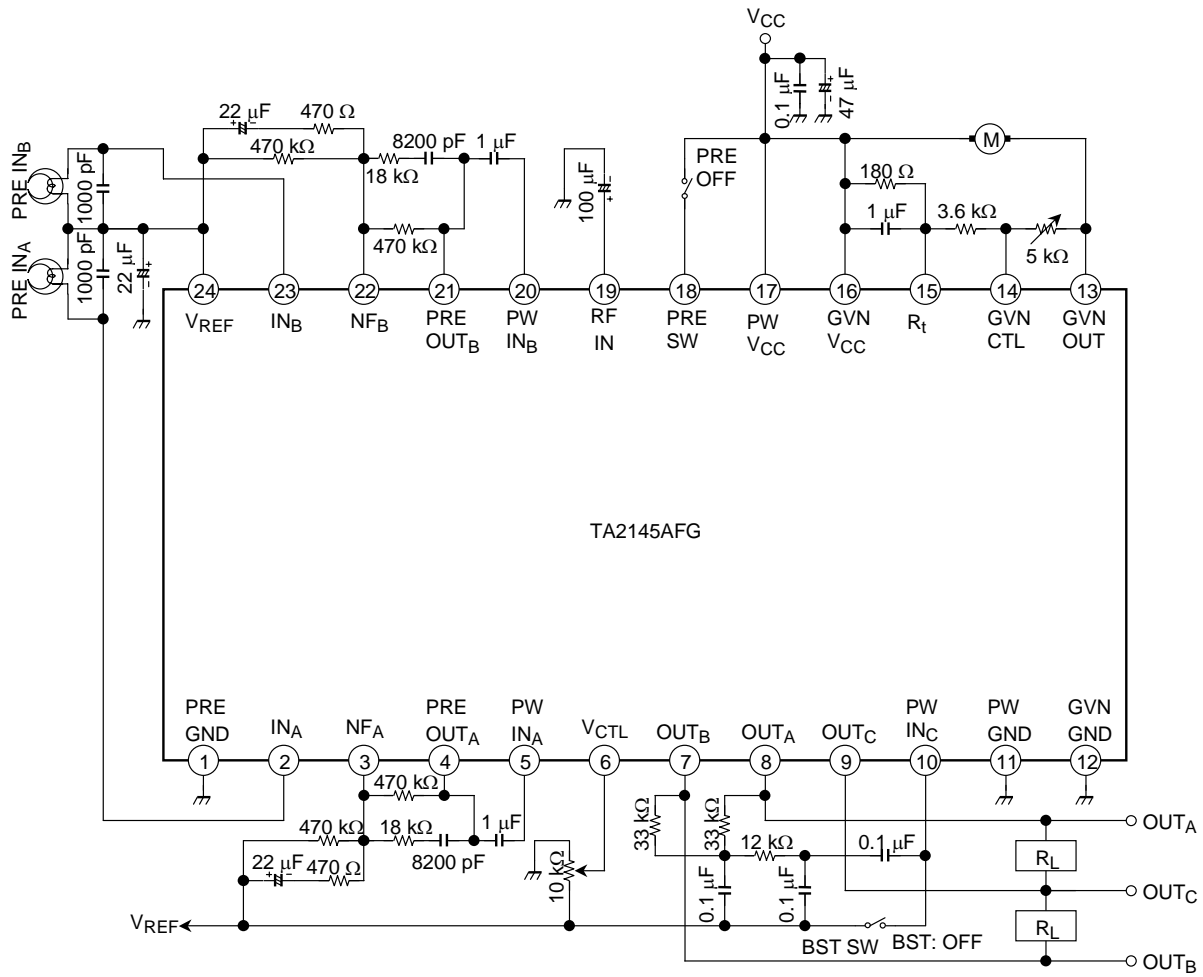

Package Dimensions

SSOP24-P-300-1.00

Unit : mm

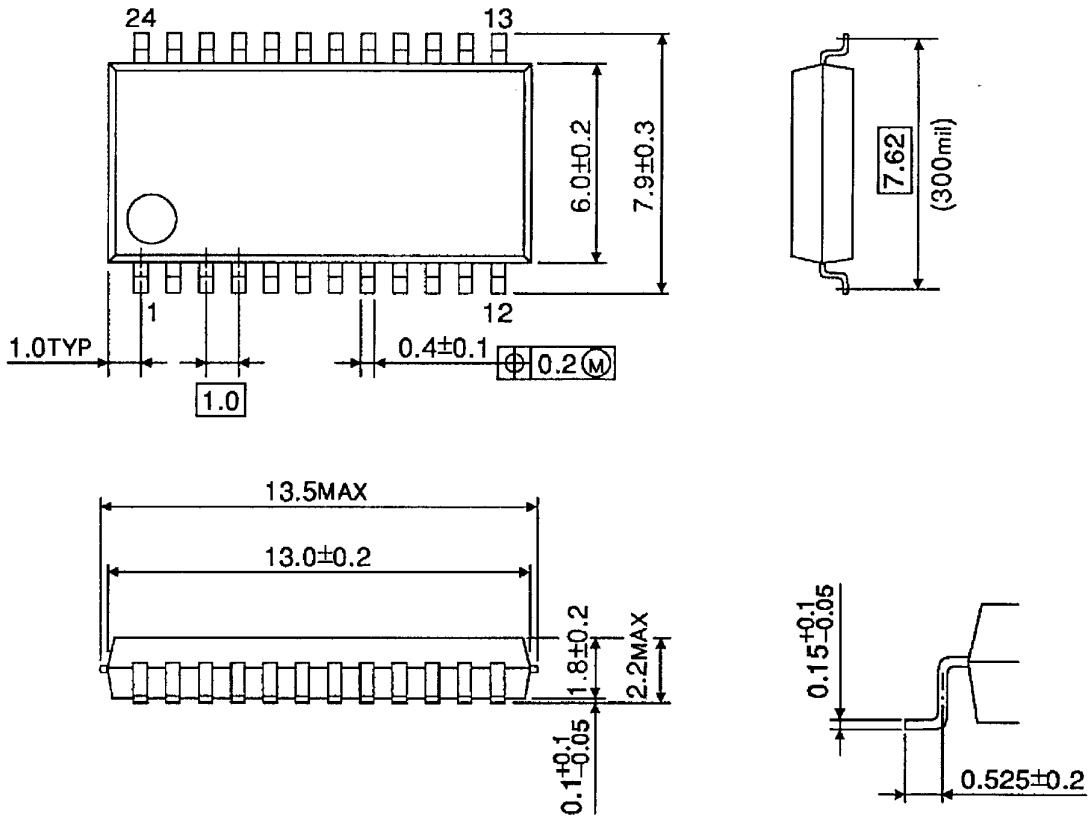

Weight: 0.32 g (typ.)

RESTRICTIONS ON PRODUCT USE

060116EBA

- The information contained herein is subject to change without notice. 021023_D
- TOSHIBA is continually working to improve the quality and reliability of its products. Nevertheless, semiconductor devices in general can malfunction or fail due to their inherent electrical sensitivity and vulnerability to physical stress. It is the responsibility of the buyer, when utilizing TOSHIBA products, to comply with the standards of safety in making a safe design for the entire system, and to avoid situations in which a malfunction or failure of such TOSHIBA products could cause loss of human life, bodily injury or damage to property.
In developing your designs, please ensure that TOSHIBA products are used within specified operating ranges as set forth in the most recent TOSHIBA products specifications. Also, please keep in mind the precautions and conditions set forth in the "Handling Guide for Semiconductor Devices," or "TOSHIBA Semiconductor Reliability Handbook" etc. 021023_A
- The TOSHIBA products listed in this document are intended for usage in general electronics applications (computer, personal equipment, office equipment, measuring equipment, industrial robotics, domestic appliances, etc.). These TOSHIBA products are neither intended nor warranted for usage in equipment that requires extraordinarily high quality and/or reliability or a malfunction or failure of which may cause loss of human life or bodily injury ("Unintended Usage"). Unintended Usage include atomic energy control instruments, airplane or spaceship instruments, transportation instruments, traffic signal instruments, combustion control instruments, medical instruments, all types of safety devices, etc. Unintended Usage of TOSHIBA products listed in this document shall be made at the customer's own risk. 021023_B
- The products described in this document shall not be used or embedded to any downstream products of which manufacture, use and/or sale are prohibited under any applicable laws and regulations. 060106_Q
- The information contained herein is presented only as a guide for the applications of our products. No responsibility is assumed by TOSHIBA for any infringements of patents or other rights of the third parties which may result from its use. No license is granted by implication or otherwise under any patent or patent rights of TOSHIBA or others. 021023_C
- The products described in this document are subject to the foreign exchange and foreign trade laws. 021023_E

About solderability, following conditions were confirmed

- Solderability
 - (1) Use of Sn-37Pb solder Bath
 - solder bath temperature = 230°C
 - dipping time = 5 seconds
 - the number of times = once
 - use of R-type flux
 - (2) Use of Sn-3.0Ag-0.5Cu solder Bath
 - solder bath temperature = 245°C
 - dipping time = 5 seconds
 - the number of times = once
 - use of R-type flux