

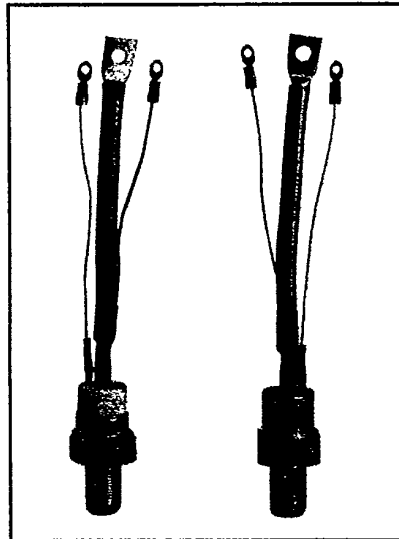

T600/T610

Powerex, Inc., Hillis Street, Youngwood, Pennsylvania 15697 (412) 925-7272
 Powerex Europe, S.A., 428 Ave. G. Durand, BP107, 72003 LeMans, France (43) 72.75.15

Phase Control SCR
 125-175 Amperes Avg
 100-1600 Volts

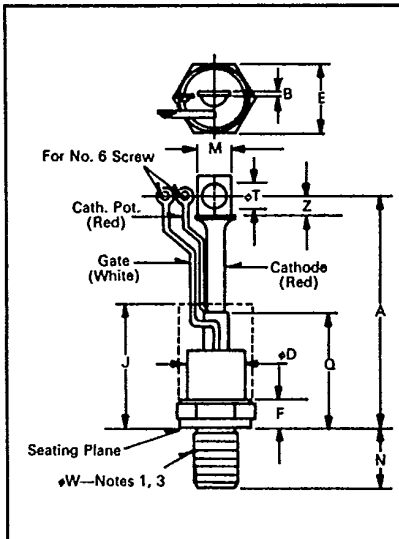

T600/T610
Phase Control SCR
 125-175 Amperes/100-1600 Volts

Conforms to TO-93
 Outline Drawing

Dimensions	Inches		Millimeters	
	Min.	Max.	Min.	Max.
A	7.750	8.100	196.85	205.74
B	.063	.172	1.60	4.37
phi D	.980	1.090	24.89	27.69
E	1.212	1.250	30.78	31.75
F	.250	.630	6.35	16.00
J	3.25	—	82.55	—
M	.530	.755	13.46	19.18
N	1.040	1.077	26.42	27.36
Q	—	2.250	—	57.15
phi T	.260	.290	6.60	7.37
Z	.340	—	8.64	—
phi W	1/4-16 UNF-2A			

- T600
 Creep Distance—.75 in. min. (19.05 mm)
 Strike Distance—.69 in. min. (17.53 mm).
- T610
 Creep Distance—.200 in. min. (5.08 mm)
 Strike Distance—.125 in. min. (3.18 mm).
- Complete threads to extend to within 2/3 threads of seating plane.
 - Angular orientation of terminals is undefined.
 - Pitch diameter of 1/4-16 UNF-2A (coated) threads (ASA B1.1—1980).
 - Dimension "J" denotes seated height with leads bent at right angles.

Description

Powerex Silicon Controlled Rectifiers (SCR) are designed for phase control applications. These are all-diffused, compression bonded encapsulated (CBE) devices employing the field-proven amplifying (di/namic) gate.

Features:

- Low On-State Voltage
- High di/dt
- High dv/dt
- Hermetic Packaging
- Excellent Surge and I²t Ratings

Applications:

- Power Supplies
- Battery Chargers
- Motor Control
- Light Dimmers
- VAR Generators

Ordering Information

Example: Select the complete eight digit part number you desire from the table – i.e. T6100613 is a 600 Volt, 125 Ampere Phase Control SCR.

Type	Voltage		Current	
	V _{ORM} V _{RRM}	Code	I _T (avg)	Code
T610	100	01	125	13
	200	02		
	300	03		
	400	04	175	18
	500	05		
	600	06		
T600	700	07	125	13
	800	08		
	900	09		
	1000	10		
	1100	11		
	1200	12		
	1300	13		
	1400	14		
	1500	15		
	1600	16		



Powerex, Inc., Hillis Street, Youngwood, Pennsylvania 15697 (412) 925-7272
 Powerex Europe, S.A., 428 Ave. G. Durand, BP107, 72003 LeMans, France (43) 72.75.15

T600/T610
 Phase Control SCR
 125-175 Amperes Avg/100-1600 Volts

Absolute Maximum Ratings

	Symbol	T600 -- 13 T610 -- 13	T600 -- 15 T610 -- 15	T600 -- 18 T610 -- 18	Units
RMS On-State Current	$I_{T(RMS)}$	200	235	275	Amperes
Average On-State Current	$I_{T(av)}$	125	150	175	Amperes
Peak One-Cycle Surge (Non-Repetitive) On-State Current (60Hz) ^①	I_{TSM}	3300	4000	5500	Amperes
Peak One-Cycle Surge (Non-Repetitive) On-State Current (50Hz) ^①	I_{TSM}	3000	3650	5000	Amperes
Critical Rate-of-Rise of On-State Current (Non-Repetitive) ^{① ② ③}	di/dt	800	800	800	Amperes/ μ s
Critical Rate-of-Rise of On-State Current (Repetitive)	di/dt	150	150	150	Amperes/ μ s
I^2t (for Fusing), 8.3 milliseconds	I^2t	45,000	66,000	120,000	A ² sec
Peak Gate Power Dissipation	P_{GM}	16	16	16	Watts
Average Gate Power Dissipation	$P_{G(av)}$	3	3	3	Watts
Storage Temperature	T_{STG}	-40 to 150	-40 to 150	-40 to 150	°C
Operating Temperature	T_J	-40 to 125	-40 to 125	-40 to 125	°C
Mounting Torque ^④		300	300	300	in.-lb.
Mounting Torque ^④		340	340	340	kg-cm

- ① Consult recommended mounting procedures.
- ② Applies for zero or negative gate bias.
- ③ Per JEDEC RS-397, 5.2.2.1.
- ④ With recommended gate drive.
- ⑤ Higher dv/dt ratings available, consult factory.
- ⑥ Per JEDEC standard RS-397, 5.2.2.6.



Powerex, Inc., Hillis Street, Youngwood, Pennsylvania 15697 (412) 925-7272

Powerex Europe, S.A., 428 Ave. G. Durand, BP107, 72003 LeMans, France (43) 72.75.15

T600/T610

Phase Control SCR

125-175 Amperes Avg/100-1600 Volts

Electrical and Thermal Characteristics

Characteristics	Symbol	Test Conditions	T600 _ _ 13	T600 _ _ 15	T600 _ _ 18	Units
			T610 _ _ 13	T610 _ _ 15	T610 _ _ 18	
Current—Conducting State Maximums						
Peak On-State Voltage	V_{TM}	$T_J = 25^\circ\text{C}, I_T = 625\text{A}$	2.05	1.8	1.55	Volts
			T600/T610			
Voltage—Blocking State Maximums^①						
Forward Leakage, Peak	I_{DRM}	$T_J = 125^\circ\text{C}, V_{DRM} = \text{rated}$		25		mA
Reverse Leakage, Peak	I_{RRM}	$T_J = 125^\circ\text{C}, V_{RRM} = \text{rated}$		25		mA
Switching						
Typical Turn-Off Time	t_q			100		μsec
Typical Turn-On Time ^②	t_{on}	$I_T = 100\text{A}, V_D = 100\text{V}$		5		μsec
Min. Critical dv/dt exponential to V_{DRM} ^③	dv/dt	$T_J = 125^\circ\text{C}$		300		V/ μsec
Thermal						
Maximum Thermal Resistance, ^④						
Junction to Case	$R_{\theta JC}$.13		$^\circ\text{C/Watt}$
Case to Sink, Lubricated	$R_{\theta CS}$.075		$^\circ\text{C/Watt}$
Gate—Maximum Parameters						
Gate Current to Trigger	I_{GT}	$T_J = 25^\circ\text{C}, V_D = 12\text{V}$		150		mA
Gate Voltage to Trigger	V_{GT}	$T_J = 25^\circ\text{C}, V_D = 12\text{V}$		3		Volts
Non-Triggering Gate Voltage	V_{GDM}	$T_J = 125^\circ\text{C}, V_{DRM} = \text{rated}$.15		Volts
Peak Forward Gate Current	I_{GTM}			4		Amperes
Peak Reverse Gate Voltage	V_{GRM}			5		Volts

① Consult recommended mounting procedures.

② Applies for zero or negative gate bias.

③ Per JEDEC RS-397, 5.2.2.1.

④ With recommended gate drive.

⑤ Higher dv/dt ratings available, consult factory.

⑥ Per JEDEC standard RS-397, 5.2.2.6.



Powerex, Inc., Hillis Street, Youngwood, Pennsylvania 15697 (412) 925-7272
 Powerex Europe, S.A., 428 Ave. G. Durand, BP107, 72003 LeMans, France (43) 72.75.15

T600/T610
 Phase Control SCR
 125-175 Amperes Avg/100-1600 Volts

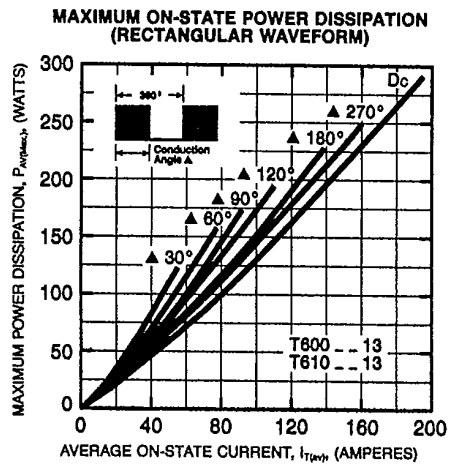
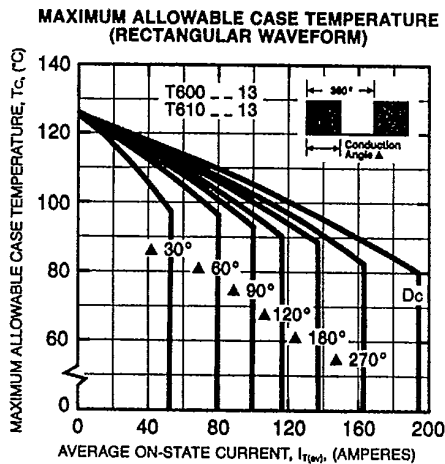
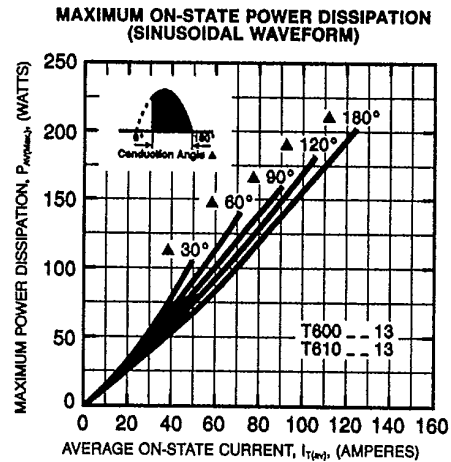
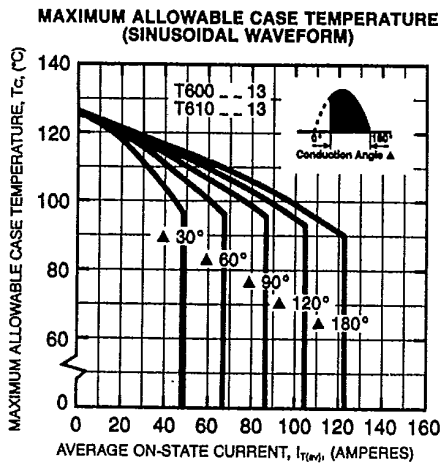
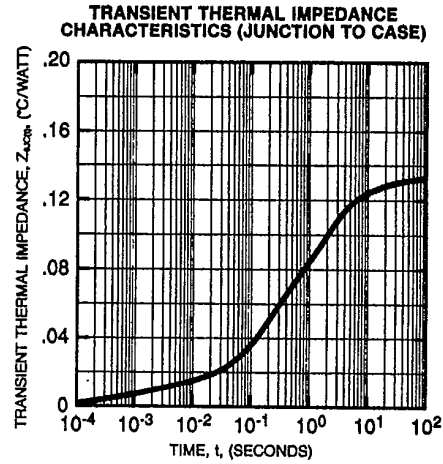
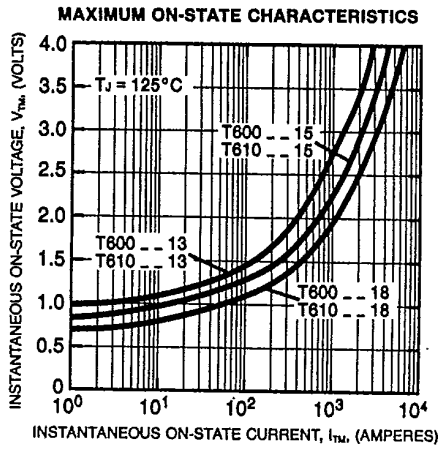



Powerex, Inc., Hillis Street, Youngwood, Pennsylvania 15697 (412) 925-7272
 Powerex Europe, S.A., 428 Ave. G. Durand, BP107, 72003 LeMans, France (43) 72.75.15

T600/T610
 Phase Control SCR
 125-175 Amperes Avg/100-1600 Volts

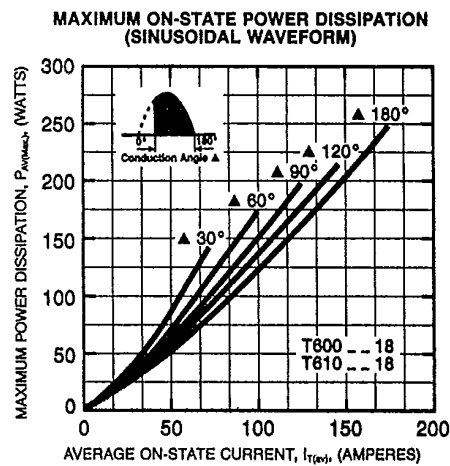
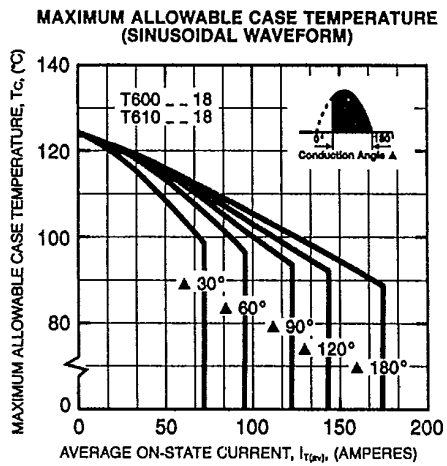
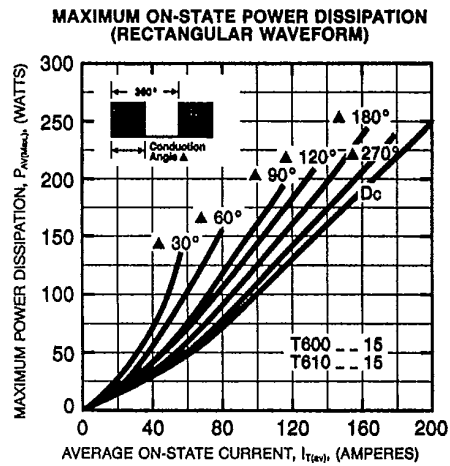
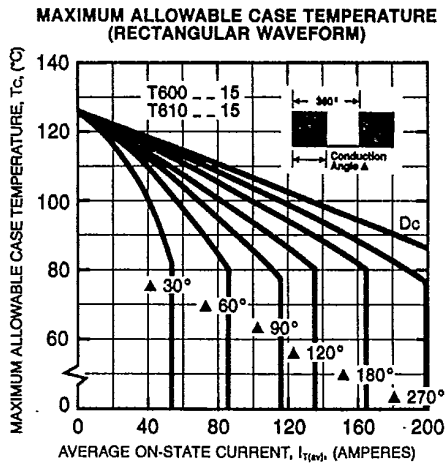
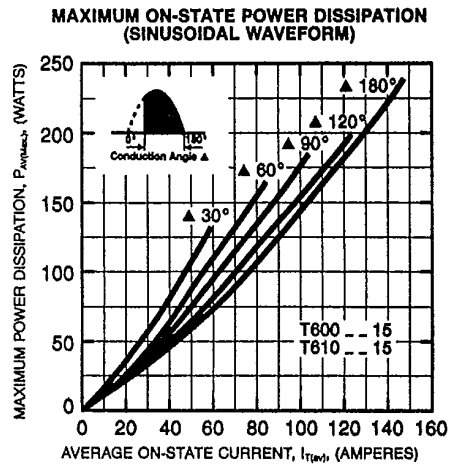
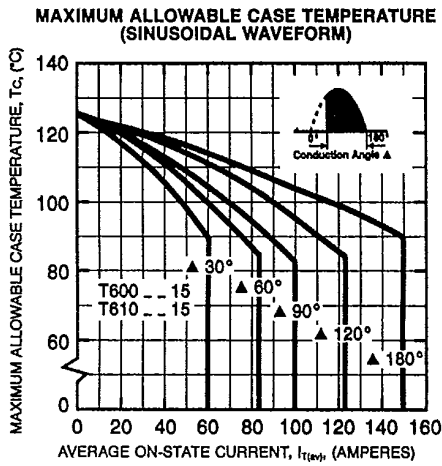



Powerex, Inc., Hillis Street, Youngwood, Pennsylvania 15697 (412) 925-7272
 Powerex Europe, S.A., 428 Ave. G. Durand, BP107, 72003 LeMans, France (43) 72.75.15

T600/T610
 Phase Control SCR
 125-175 Amperes Avg/100-1600 Volts

