

4-port lvds and 4-port TTL-to LVDS repeaters

Feature summary

- Receiver and drivers meet or exceed the requirements of ansi eia/tia-644 standard, receivers differential input levels, $\pm 100\text{mV}$
- Designed for signaling rates up to 630mbps
- Operates from a single 3.3V supply
- Low voltage differential signaling with typical output voltage of 350mV and a 100 Ω load
- Propagation delay time: 3.1ns (typ)
- Electrically compatible with LVDS, PECL, LVPECL, LVTTTL, LVCOMOS, GTL, BTL, CTT, SSTL, or HSTL outputs with external network
- Bus terminal ESD (HBM) exceeds 7kV
- TSSOP package

Description

The STLVDS104 is a differential line receiver and a LVTTTL input connected to four differential line drivers that implement the electrical characteristics of low voltage differential signaling, for point to point baseband data transmission over controlled impedance media of approximately 100 Ω . The transmission media can be printed-circuit board traces, backplanes, or cable.

LVDS, as specified in EIA/TIA-644 is a data signaling technique that offers low-power, low

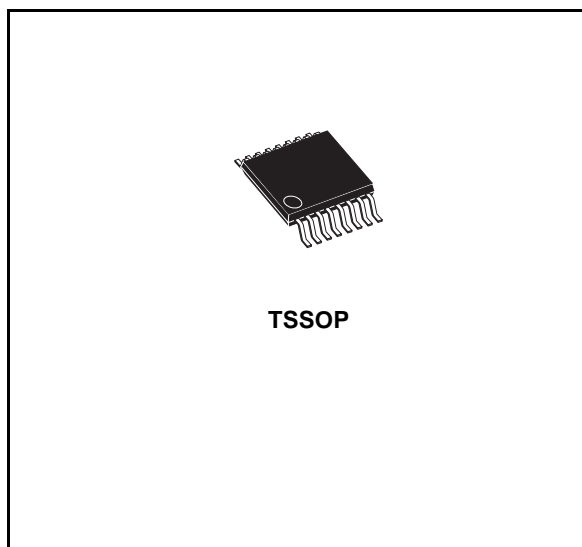

noise coupling, and switching speed to transmit data at a speed up to 630Mbps at relatively long distances.

The drivers integrated into the same substrate, along with the low pulse skew of balanced signaling, allow extremely precise timing alignment of the signals repeated from the input.

The device allows extremely precise timing alignment of the signal repeated from the input. This is particularly advantageous in distribution or expansion of signals such as clock or serial data stream.

Order codes

Type	Temperature Range	Package	Comments
STLVDS104BTR	-40 to 85 °C	TSSOP16 (Tape & Reel)	2500 parts per reel

Contents

1	Pin configuration	3
2	Maximum ratings	4
3	Electrical characteristics	5
4	Typical performance characteristics	7
5	Package mechanical data	8
6	Revision history	11

1 Pin configuration

Figure 1. Pin connections and functional diagram

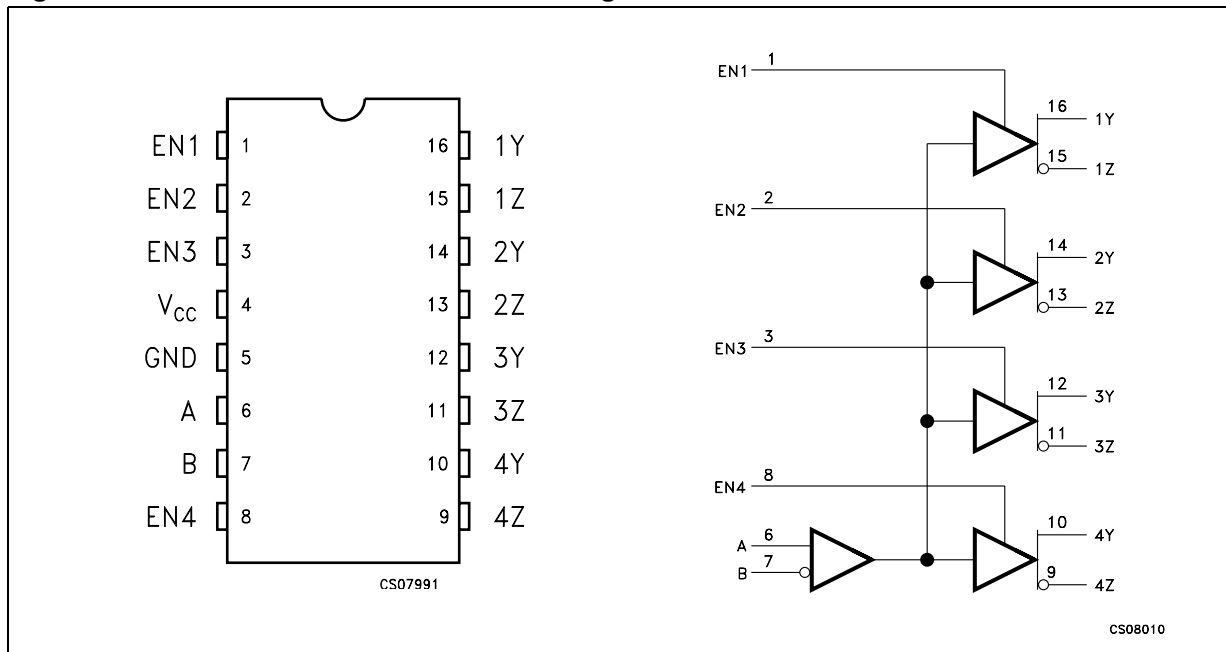

Table 1. Pin description

Pin n°	Symbol	Name and function
1, 2, 3, 8	EN1 to EN4	Enable Driver Inputs
6, 7	A, B	Receiver Input
9, 11, 13, 15	1Z to 4Z	Driver Inputs
10, 12, 14, 16	1X to 4X	Driver Inputs
5	GND	Ground
4	V _{CC}	Supply Voltage

Table 2. Truth table for receiver

Input	Enables	Outputs	
		#Y	#Z
$V_{ID} = V_A - V_B$	#EN	#Y	#Z
X	X	Z	Z
X	L	Z	Z
$V_{ID} \geq 100mV$	H	H	L
$-100mV < V_{ID} < 100mV$	H	?	?
$V_{ID} \leq -100mV$	H	L	H

L=Low level, H=High level, X=Don't care, Z= High impedance,?=Indeterminate

2 Maximum ratings

Table 3. Absolute maximum ratings

Symbol	Parameter		Value	Unit
V_{CC}	Supply voltage (Note 1)		-0.5 to 4	V
V_R	Voltage range	Enable inputs	-0.5 to 6	V
		A, B, Y or Z	-0.5 to 4	V
ESD	ESD Protection voltage (HBM)	Y, Z, to GND	7	KV
		All Pins	2	KV
T_{stg}	Storage temperature range		-65 to +150	°C

Note: Absolute Maximum Ratings are those values beyond which damage to the device may occur. Functional operation under these condition is not implied.

Note: 1 All voltages except differential I/O bus voltage, are with respect to the network ground terminal.

Table 4. Recommended operating conditions

Symbol	Parameter	Min.	Typ.	Max.	Unit
V_{CC}	Supply voltage	3.0	3.3	3.6	V
V_{IH}	HIGH level input voltage	2.0			V
V_{IL}	LOW level input voltage			0.8	V
$ V_{ID} $	Magnitude of differential input voltage	0.1		3.6	V
V_{IC}	Common mode input voltage	$ V_{ID} /2$		$24- V_{ID} /2$	V
				$V_{CC}-0.8$	
T_A	Operating temperature range	-40		85	°C

3 Electrical characteristics

Table 5. Electrical characteristics

($T_A = -40$ to 85°C , and $V_{CC} = 3.3\text{V} \pm 10\%$ over recommended operating conditions unless otherwise noted. All typical values are at $T_A = 25^\circ\text{C}$).

Symbol	Parameter	Test	Min.	Typ.	Max.	Unit
$V_{\text{ITH+}}$	Positive-going differential input voltage threshold				100	mV
$V_{\text{ITH-}}$	Negative-going differential input voltage threshold		-100			mV
$ V_{\text{OD}} $	Differential output voltage magnitude	$R_L = 100\Omega, V_{\text{ID}} = \pm 100\text{mV}$	247	340	454	mV
$\Delta V_{\text{OD}} $	Change in differential output voltage magnitude between logic state		-50		50	mV
$\Delta V_{\text{OC(SS)}}$	Change in steady-state common mode output voltage between logic state		-50		50	mV
$V_{\text{OC(SS)}}$	Steady-state Common Mode Output Voltage		1.125	1.2	1.375	V
$V_{\text{OC(PP)}}$	Peak to peak common mode output voltage			25	150	mV
I_{CC}	Supply current	Enabled, $R_L = 100\Omega$		20	30	mA
		Disabled		2.5	5	mA
I_{I}	Input current (A or B Inputs)	$V_{\text{I}} = 0\text{V}$	-2	-11	-20	μA
		$V_{\text{I}} = 2.4\text{V}$	-1	-3		μA
$I_{\text{I(OFF)}}$	Power OFF input current	$V_{\text{CC}} = 1.5\text{V}, V_{\text{I}} = 2.4\text{V}$		3	20	μA
I_{IH}	High level input current	$V_{\text{IH}} = 2\text{V}$		7	20	μA
I_{IL}	Low level input current	$V_{\text{IL}} = 0.8\text{V}$		3	10	μA
I_{OC}	Short circuit output current	$V_{\text{O(Y)}} \text{ or } V_{\text{O(Z)}} = 0\text{V}$		± 6	± 10	mA
		$V_{\text{OD}} = 0$		± 3	± 10	mA
I_{OZ}	High Impedance output current	$V_{\text{O}} = 0 \text{ or } 2.4\text{V}$			± 1	μA
$I_{\text{O(OFF)}}$	Power OFF output current	$V_{\text{CC}} = 1.5\text{V}, V_{\text{O}} = 2.4\text{V}$			± 1	μA
C_{IN}	Input capacitance (A or B inputs)	$V_{\text{I}} = 0.4 \sin(4e^{6\pi t}) + 0.5\text{V}$		3		pF
C_{O}	Output capacitance (Y or Z outputs)	$V_{\text{I}} = 0.4 \sin(4e^{6\pi t}) + 0.5\text{V}, \text{ Disabled}$		6		pF

Table 6. Switching characteristics

($T_A = -40$ to 85°C , and $V_{CC} = 3.3\text{V}$ unless otherwise noted. All typical values are at $T_A = 25^\circ\text{C}$).

Symbol	Parameter	Test	Min.	Typ.	Max.	Unit
t_{PLH}	Propagation delay time, low to high output	$R_L = 100\Omega$ $C_L = 10\text{pF}$	2.4	3.2	4.2	ns
t_{PHL}	Propagation delay time, high to low output		2.2	3.1	4.2	ns
t_r	Differential output signal rise time		0.3	0.7	1.2	ns
t_f	Differential output signal fall time		0.3	0.7	1.2	ns
$t_{sk(P)}$	Pulse skew ($ t_{THL} - t_{TLH} $)			100	300	ps
$t_{sk(O)}$	Channel-to-channel output skew ⁽¹⁾			50	100	ps
$t_{sk(pp)}$	Part to part skew ⁽²⁾			1.5	ns	
t_{PZH}	Propagation delay time, high impedance to high level output			7.2	15	ns
t_{PZL}	Propagation delay time, high impedance to low level output			8.4	15	ns
t_{PHZ}	Propagation delay time, high level to high impedance output			3.6	15	ns
t_{PLZ}	Propagation delay time, low level to high impedance output			6	15	ns

- $t_{sk(O)}$ is the time difference between the t_{PLH} or t_{PHL} of all drivers of a single device with all their inputs connected together
- $t_{sk(pp)}$ is the magnitude of the difference in propagation delay times between any specified terminals of two devices when both devices operate with the same supply voltages, at the same temperature, and have identical packages and test circuit

4 Typical performance characteristics

(Unless otherwise specified $T_J = 25^\circ\text{C}$)

Figure 2. Output current vs output high voltage

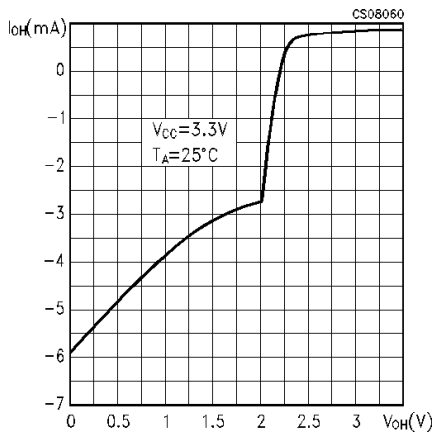

Figure 3. Output current vs output low voltages

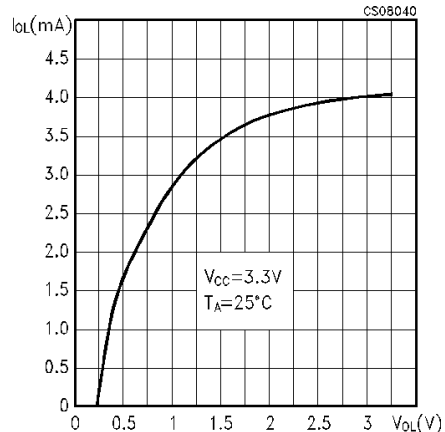

Figure 4. High to low propagation delay time

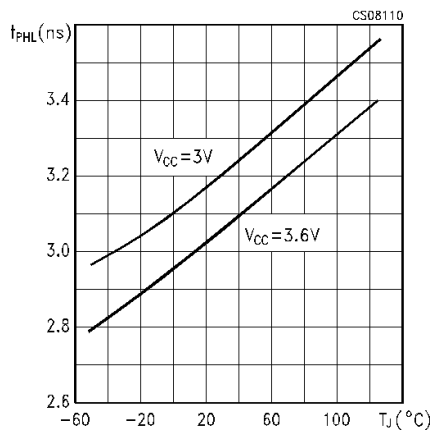
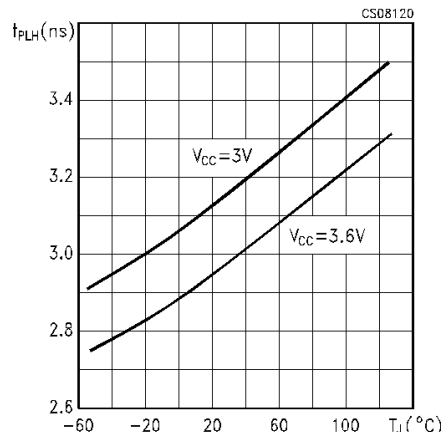

Figure 5. Low to high propagation delay time



5 Package mechanical data

In order to meet environmental requirements, ST offers these devices in ECOPACK® packages. These packages have a Lead-free second level interconnect. The category of second Level Interconnect is marked on the package and on the inner box label, in compliance with JEDEC Standard JESD97. The maximum ratings related to soldering conditions are also marked on the inner box label. ECOPACK is an ST trademark. ECOPACK specifications are available at: www.st.com.

TSSOP16 MECHANICAL DATA

DIM.	mm.			inch		
	MIN.	TYP	MAX.	MIN.	TYP.	MAX.
A			1.2			0.047
A1	0.05		0.15	0.002	0.004	0.006
A2	0.8	1	1.05	0.031	0.039	0.041
b	0.19		0.30	0.007		0.012
c	0.09		0.20	0.004		0.0079
D	4.9	5	5.1	0.193	0.197	0.201
E	6.2	6.4	6.6	0.244	0.252	0.260
E1	4.3	4.4	4.48	0.169	0.173	0.176
e		0.65 BSC			0.0256 BSC	
K	0°		8°	0°		8°
L	0.45	0.60	0.75	0.018	0.024	0.030

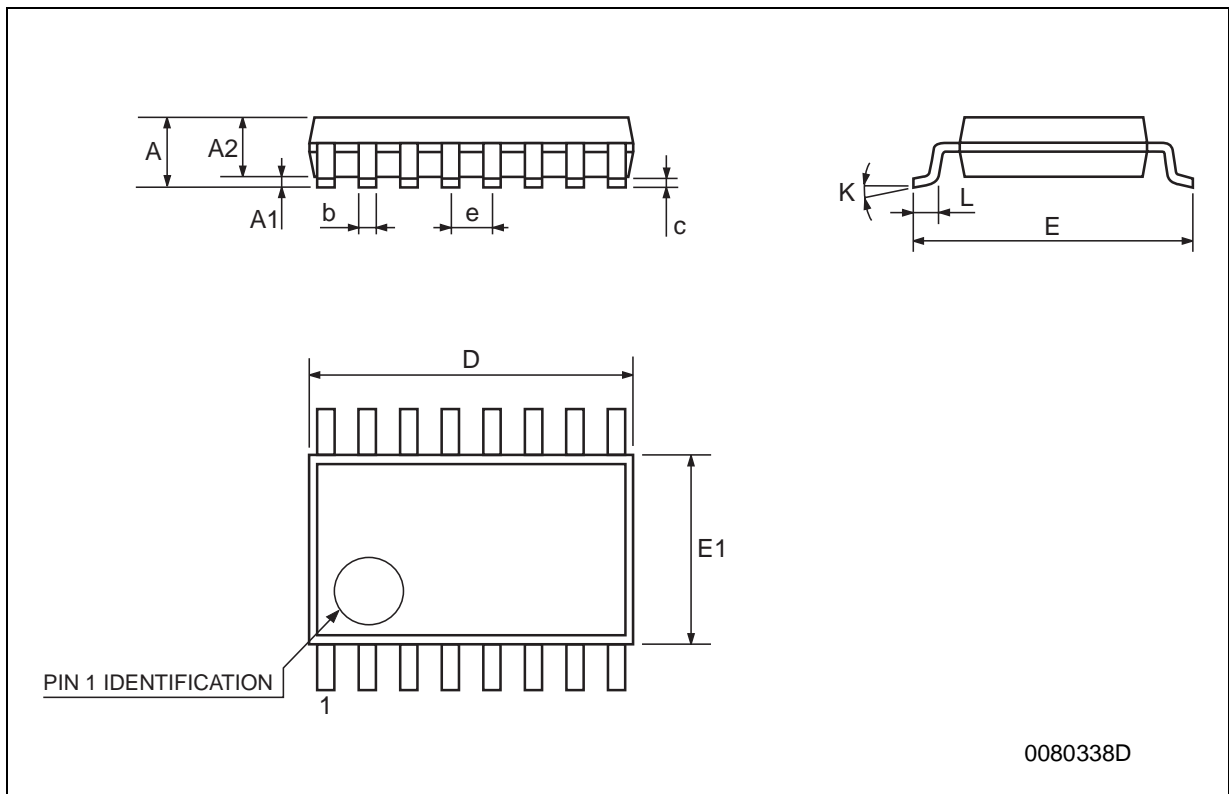

0080338D

Tape & Reel TSSOP16 MECHANICAL DATA

DIM.	mm.			inch		
	MIN.	TYP	MAX.	MIN.	TYP.	MAX.
A			330			12.992
C	12.8		13.2	0.504		0.519
D	20.2			0.795		
N	60			2.362		
T			22.4			0.882
Ao	6.7		6.9	0.264		0.272
Bo	5.3		5.5	0.209		0.217
Ko	1.6		1.8	0.063		0.071
Po	3.9		4.1	0.153		0.161
P	7.9		8.1	0.311		0.319

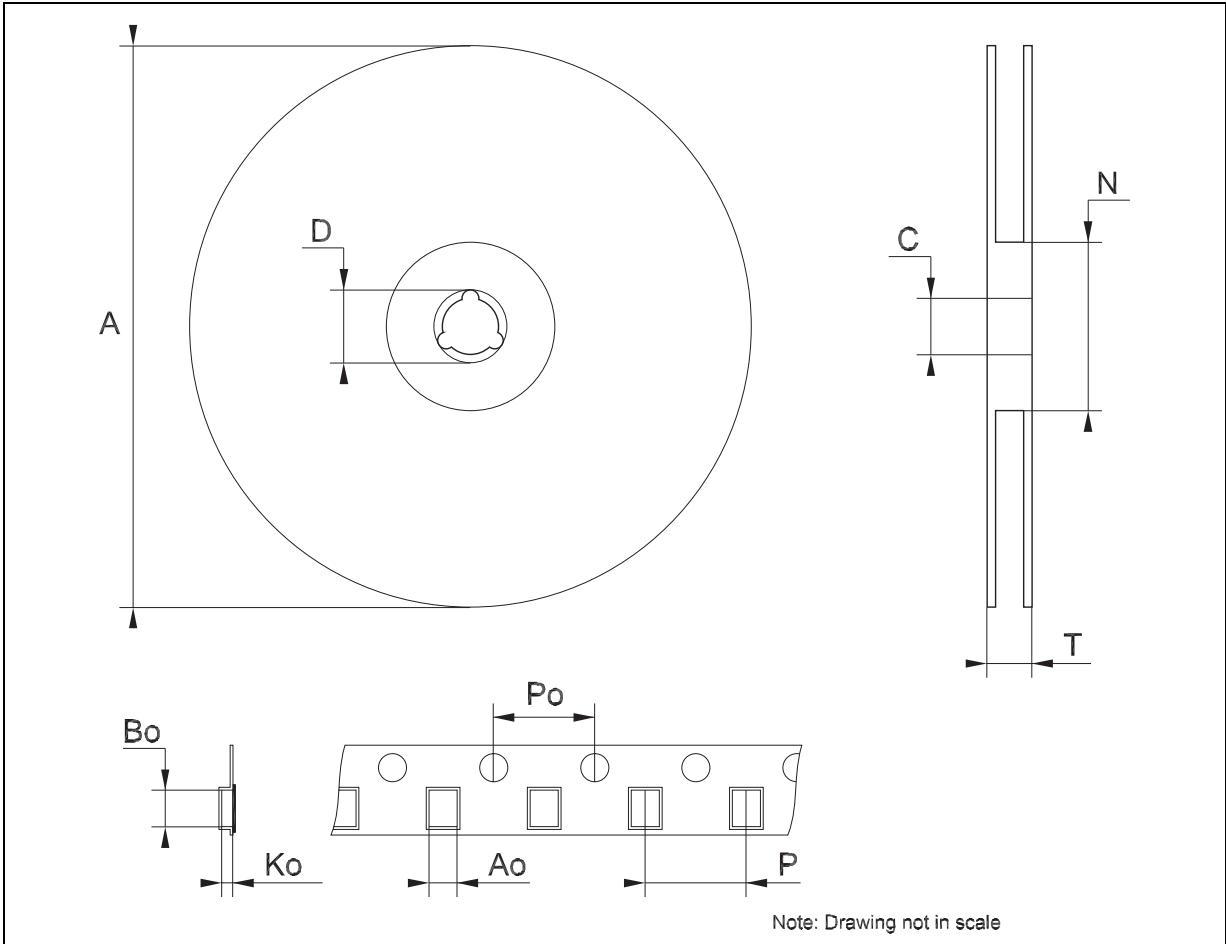

6 Revision history

Table 7. Revision history

Date	Revision	Changes
14-Mar-2006	5	Order codes has been updated and new template.

Please Read Carefully:

Information in this document is provided solely in connection with ST products. STMicroelectronics NV and its subsidiaries ("ST") reserve the right to make changes, corrections, modifications or improvements, to this document, and the products and services described herein at any time, without notice.

All ST products are sold pursuant to ST's terms and conditions of sale.

Purchasers are solely responsible for the choice, selection and use of the ST products and services described herein, and ST assumes no liability whatsoever relating to the choice, selection or use of the ST products and services described herein.

No license, express or implied, by estoppel or otherwise, to any intellectual property rights is granted under this document. If any part of this document refers to any third party products or services it shall not be deemed a license grant by ST for the use of such third party products or services, or any intellectual property contained therein or considered as a warranty covering the use in any manner whatsoever of such third party products or services or any intellectual property contained therein.

UNLESS OTHERWISE SET FORTH IN ST'S TERMS AND CONDITIONS OF SALE ST DISCLAIMS ANY EXPRESS OR IMPLIED WARRANTY WITH RESPECT TO THE USE AND/OR SALE OF ST PRODUCTS INCLUDING WITHOUT LIMITATION IMPLIED WARRANTIES OF MERCHANTABILITY, FITNESS FOR A PARTICULAR PURPOSE (AND THEIR EQUIVALENTS UNDER THE LAWS OF ANY JURISDICTION), OR INFRINGEMENT OF ANY PATENT, COPYRIGHT OR OTHER INTELLECTUAL PROPERTY RIGHT.

UNLESS EXPRESSLY APPROVED IN WRITING BY AN AUTHORIZED REPRESENTATIVE OF ST, ST PRODUCTS ARE NOT DESIGNED, AUTHORIZED OR WARRANTED FOR USE IN MILITARY, AIR CRAFT, SPACE, LIFE SAVING, OR LIFE SUSTAINING APPLICATIONS, NOR IN PRODUCTS OR SYSTEMS, WHERE FAILURE OR MALFUNCTION MAY RESULT IN PERSONAL INJURY, DEATH, OR SEVERE PROPERTY OR ENVIRONMENTAL DAMAGE.

Resale of ST products with provisions different from the statements and/or technical features set forth in this document shall immediately void any warranty granted by ST for the ST product or service described herein and shall not create or extend in any manner whatsoever, any liability of ST.

ST and the ST logo are trademarks or registered trademarks of ST in various countries.

Information in this document supersedes and replaces all information previously supplied.

The ST logo is a registered trademark of STMicroelectronics. All other names are the property of their respective owners.

© 2006 STMicroelectronics - All rights reserved

STMicroelectronics group of companies

Australia - Belgium - Brazil - Canada - China - Czech Republic - Finland - France - Germany - Hong Kong - India - Israel - Italy - Japan - Malaysia - Malta - Morocco - Singapore - Spain - Sweden - Switzerland - United Kingdom - United States of America

www.st.com