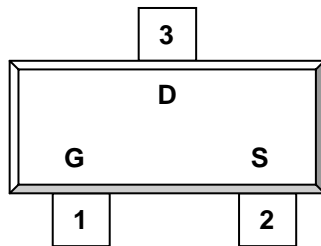

DESCRIPTION

ST3414 is the N-Channel logic enhancement mode power field effect transistor which is produced using high cell density, DMOS trench technology. This high density process is especially tailored to minimize on-state resistance. These devices are particularly suited for low voltage application such as cellular phone and notebook computer power management, other battery powered circuits, and low in-line power loss are required. The product is in a very small outline surface mount package.

PIN CONFIGURATION
SOT-23-3L

1. Gate 2. Source 3. Drain

FEATURE

- 20V/4.2A, $R_{DS(ON)} = 40m\Omega$ (Typ.) @VGS = 4.5V
- 20V/3.4A, $R_{DS(ON)} = 55 m\Omega$ @VGS = 2.5V
- 20V/2.8A, $R_{DS(ON)} = 75 m\Omega$ @VGS = 1.8V
- Super high density cell design for extremely low $R_{DS(ON)}$
- Exceptional on-resistance and maximum DC current capability
- SOT-23-3L package design

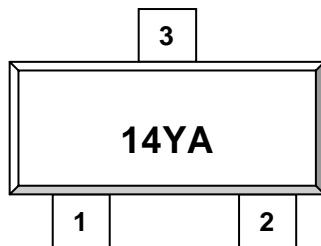
PART MARKING
SOT-23-3L

Y: Year Code A: Week Code

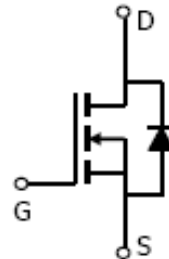

ORDERING INFORMATION

Part Number	Package	Part Marking
ST3414S23RG	SOT-23	14YA

※ Week Code : A ~ Z ; a ~ z

※ ST3414S23RG : S23 : SOT23-3L R : Tape Reel ; G : Pb - Free



ST3414  Lead-free

N Channel Enhancement Mode MOSFET

4.0A

ABSOLUTE MAXIMUM RATINGS (Ta = 25°C Unless otherwise noted)

Parameter	Symbol	Typical	Unit
Drain-Source Voltage	V _{DSS}	20	V
Gate-Source Voltage	V _{GSS}	±12	V
Continuous Drain Current (T _J =150°C)	I _D	T _A =25°C 4.0	A
		T _A =70°C 3.2	
Pulsed Drain Current	I _{DM}	30	A
Continuous Source Current (Diode Conduction)	I _S	1.6	A
Power Dissipation	P _D	T _A =25°C 1.25	W
		T _A =70°C 0.8	
Operation Junction Temperature	T _J	-55/150	°C
Storage Temperature Range	T _{STG}	-55/150	°C
Thermal Resistance-Junction to Ambient	R _{θJA}	125	°C/W



ST3414 

N Channel Enhancement Mode MOSFET

4.0A

ELECTRICAL CHARACTERISTICS (Ta = 25°C Unless otherwise noted)

Parameter	Symbol	Condition	Min	Typ	Max	Unit
Static						
Drain-Source Breakdown Voltage	$V_{(BR)DSS}$	$V_{GS}=0V, I_D=-250\mu A$	20			V
Gate Threshold Voltage	$V_{GS(th)}$	$V_{DS}=V_{GS}, I_D=250\mu A$	0.40		1.0	V
Gate Leakage Current	I_{GSS}	$V_{DS}=0V, V_{GS}=\pm 12V$			± 100	nA
Zero Gate Voltage Drain Current	I_{DSS}	$V_{DS}=20V, V_{GS}=0V$			1	uA
		$V_{DS}=20V, V_{GS}=0V$ $T_J=55^\circ C$			5	
On-State Drain Current	$I_{D(on)}$	$V_{DS} \geq 5V, V_{GS}=4.5V$	6			A
Drain-source On-Resistance	$R_{DS(on)}$	$V_{GS}=4.5V, I_D=4.2A$ $V_{GS}=2.5V, I_D=3.4A$ $V_{GS}=1.8V, I_D=2.8A$		0.040 0.055 0.075		Ω
Forward Transconductance	g_{fs}	$V_{DS}=5V, I_D=3.6V$		10		S
Diode Forward Voltage	V_{SD}	$I_S=1.6A, V_{GS}=0V$		0.8	1.2	V
Dynamic						
Total Gate Charge	Q_g	$V_{DS}=10V$ $V_{GS}=4.5V$ $I_D=2.8A$		4.8	8	nC
Gate-Source Charge	Q_{gs}			1.0		
Gate-Drain Charge	Q_{gd}			1.0		
Input Capacitance	C_{iss}	$V_{DS}=6V$ $V_{GS}=0V$ $f=1MHz$		485		pF
Output Capacitance	C_{oss}			85		
Reverse Transfer Capacitance	C_{rss}			40		
Turn-On Time	$t_{d(on)tr}$	$V_{DD}=6V$ $R_L=6\Omega$ $I_D=1.0A$ $V_{GEN}=4.5V$ $R_G=6\Omega$		8	14	nS
				12	18	
Turn-Off Time	$t_{d(off)tf}$			30	35	
				12	16	

TYPICAL CHARACTERISTICS (25°C Unless noted)

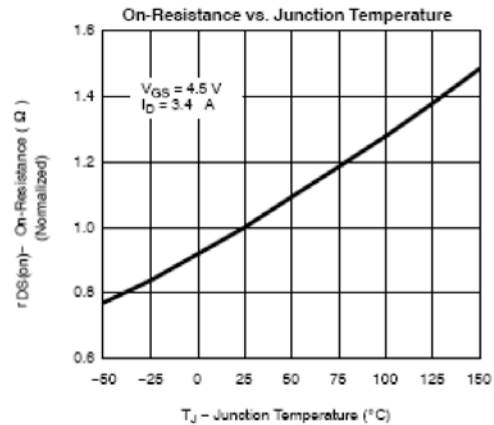
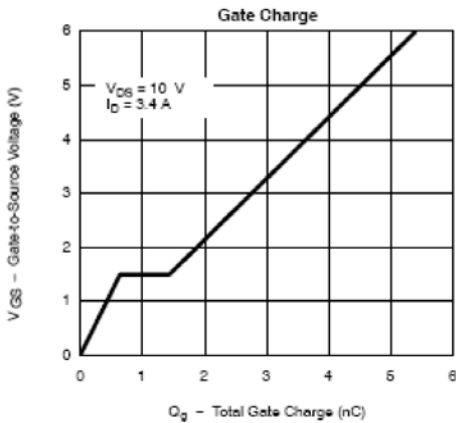
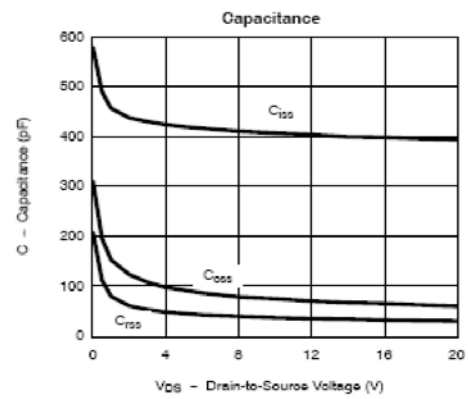
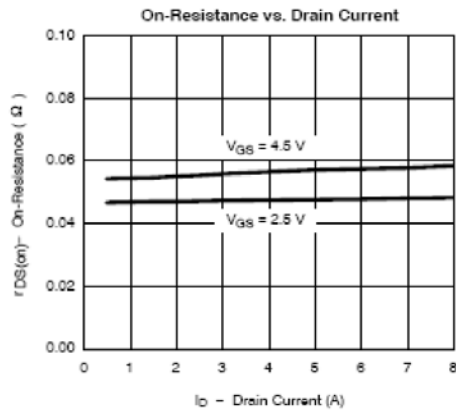
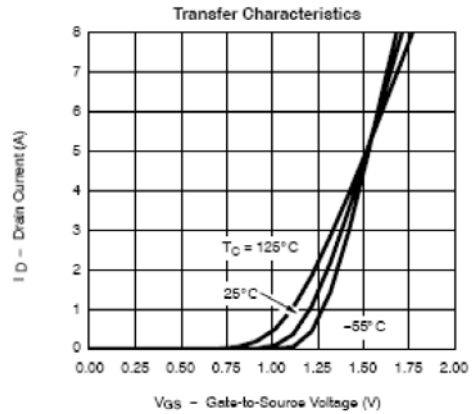
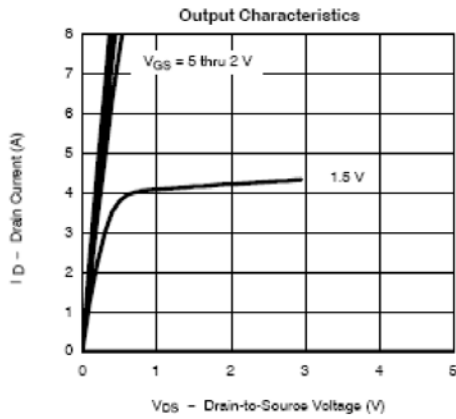

TYPICAL CHARACTERISTICS (25°C Unless noted)

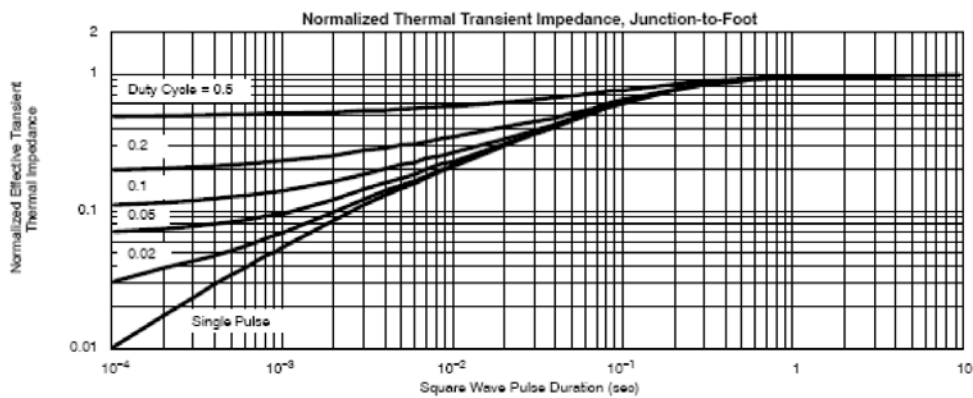
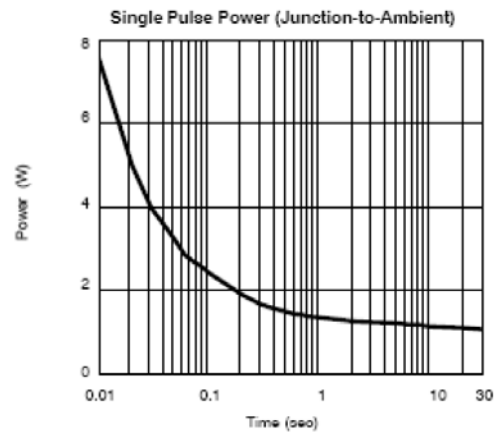
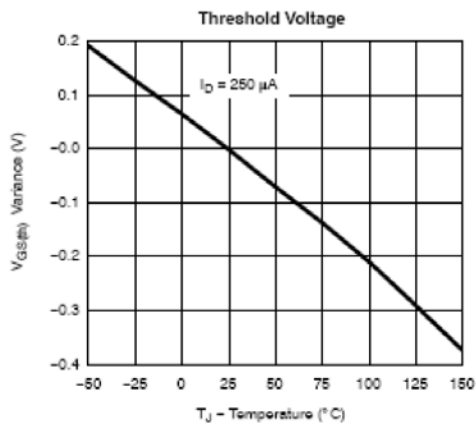
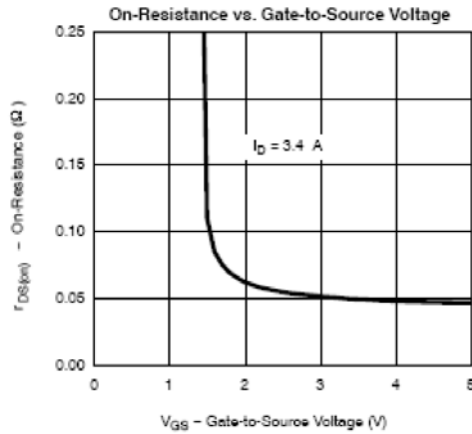
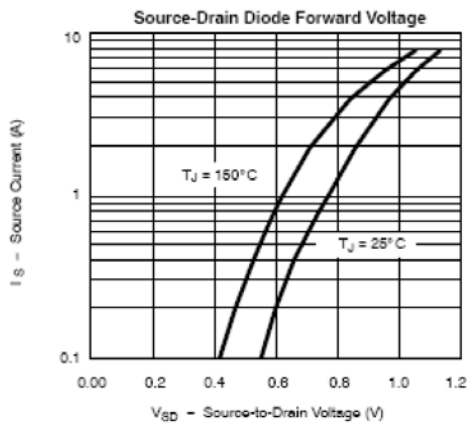

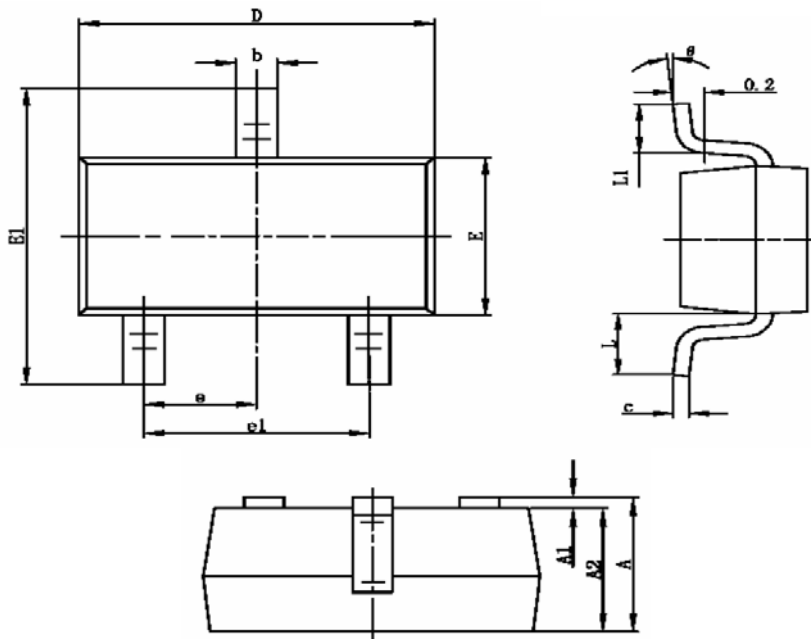
SOT-23-3L PACKAGE OUTLINE

Symbol	Dimensions In Millimeters		Dimensions In Inches	
	Min	Max	Min	Max
A	1.050	1.250	0.041	0.049
A1	0.000	0.100	0.000	0.004
A2	1.050	1.150	0.041	0.045
b	0.300	0.400	0.012	0.016
c	0.100	0.200	0.004	0.008
D	2.820	3.020	0.111	0.119
E	1.500	1.700	0.059	0.067
E1	2.650	2.950	0.104	0.116
e	0.950TYP		0.037TYP	
e1	1.800	2.000	0.071	0.079
L	0.700REF		0.028REF	
L1	0.300	0.600	0.012	0.024
θ	0°	8°	0°	8°