



A New Direction in Mixed-Signal

SP490E/491E

Enhanced Full Duplex RS-485 Transceivers

FEATURES

- +5V Only
- Low Power BiCMOS
- Driver/Receiver Enable (SP491E)
- RS-485 and RS-422 Drivers/Receivers
- Pin Compatible with LTC490 and SN75179 (SP490E)
- Pin Compatible with LTC491 and SN75180 (SP491E)
- Improved ESD Specifications:
 - ±15kV Human Body Model
 - ±15kV IEC61000-4-2 Air Discharge

Now Available in Lead Free Packaging

DESCRIPTION

The **SP490E** is a low power differential line driver/receiver meeting RS-485 and RS-422 standards up to 10Mbps. The **SP491E** is identical to the **SP490E** with the addition of driver and receiver tri-state enable lines. Both products feature $\pm 200\text{mV}$ receiver input sensitivity, over wide common mode range. The **SP490E** is available in 8-pin plastic DIP and 8-pin NSOIC packages for operation over the commercial and industrial temperature ranges. The **SP491E** is available in 14-pin DIP and 14-pin NSOIC packages for operation over the commercial and industrial temperature ranges.

BLOCK DIAGRAMS

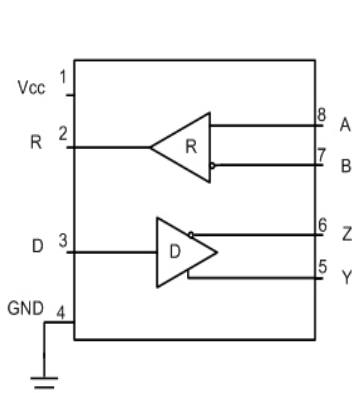

SP490E

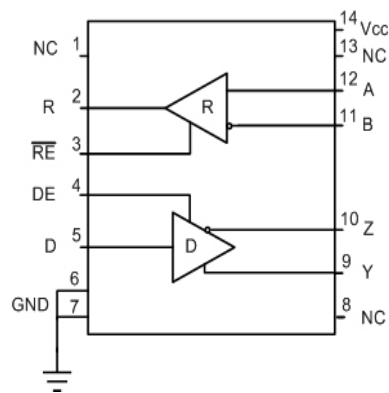

SP491E

ABSOLUTE MAXIMUM RATINGS

These are stress ratings only and functional operation of the device at these ratings or any other above those indicated in the operation sections of the specifications below is not implied. Exposure to absolute maximum rating conditions for extended periods of time may affect reliability.

V _{CC}	+7V
Input Voltages	
Drivers.....	-0.5V to (V _{CC} +0.5V)
Receivers.....	±14V
Output Voltages	
Drivers.....	±14V
Receivers.....	-0.5V to (V _{CC} +0.5V)
Storage Temperature.....	-65° C to +150°
Power Dissipation.....	1000mW

ELECTRICAL CHARACTERISTICS

T_{MIN} to T_{MAX} and V_{CC} = 5V ± 5% unless otherwise noted.

PARAMETERS	MIN.	TYP.	MAX.	UNITS	CONDITIONS
SP490E DRIVER					
DC Characteristics					
Differential Output Voltage	GND		V _{CC}	Volts	Unloaded; R = ∞ ; see figure 1
Differential Output Voltage	2		V _{CC}	Volts	With Load; R = 50Ω; (RS422); see figure 1
Differential Output Voltage	1.5		V _{CC}	Volts	With Load; R = 27Ω; (RS485); see figure 1
Change in Magnitude of Driver Differential Output Voltage for Complimentary States Driver Common-Mode Output Voltage			0.2	Volts	R = 27Ω or R = 50Ω; see figure 1
Input High Voltage	2.0		3	Volts	R = 27Ω or R = 50Ω; see figure 1
Input Low Voltage			0.8	Volts	Applies to D
Input Current			±10	μA	Applies to D
Driver Short-Circuit Current			250	mA	-7V ≤ V _O ≤ +12V
V _{OUT} = HIGH			250	mA	-7V ≤ V _O ≤ +12V
V _{OUT} = LOW					
SP490E DRIVER					
AC Characteristics					
Maximum Data Rate	10			Mbps	
Driver Input to Output		30	60	ns	t _{PLH} *; R _{DIFF} = 54Ω, C _{L1} = C _{L2} = 100pF; see figures 3 and 5
Driver Input to Output		30	60	ns	t _{PHL} *; R _{DIFF} = 54Ω, C _{L1} = C _{L2} = 100pF; see figures 3 and 5
Driver Skew		5		ns	see figures 3 and 5,
Driver Rise or Fall Time		15	40	ns	t _{SKEW} = t _{DPLH} - t _{DPHL} From 10% to 90%; R _{DIFF} = 54Ω, C _{L1} = C _{L2} = 100pF; see figures 3 and 5
SP490E RECEIVER					
DC Characteristics					
Differential Input Threshold	-0.2		+0.2	Volts	-7V ≤ V _{CM} ≤ 12V
Input Hysteresis		70		mV	V _{CM} = 0V
Output Voltage High	3.5			Volts	I _O = -4mA, V _{ID} = +200mV
Output Voltage Low			0.4	Volts	I _O = +4mA, V _{ID} = -200mV
Input Resistance	12	15		kΩ	-7V ≤ V _{CM} ≤ 12V
Input Current (A, B); V _{IN} = 12V			±1.0	mA	V _{IN} = 12V
Input Current (A, B); V _{IN} = -7V			-0.8	mA	V _{IN} = -7V
Short-Circuit Current			85	mA	0V ≤ V _O ≤ V _{CC}

ELECTRICAL CHARACTERISTICS

T_{MIN} to T_{MAX} and $V_{CC} = 5V \pm 5\%$ unless otherwise noted.

PARAMETERS	MIN.	TYP.	MAX.	UNITS	CONDITIONS
SP490E RECEIVER					
AC Characteristics					
Maximum Data Rate	10			Mbps	
Receiver Input to Output	20	45	100	ns	t_{PLH}^1 ; $R_{DIFF} = 54\Omega$, $C_{L1} = C_{L2} = 100pF$; Figures 3 & 7
Receiver Input to Output	20	45	100	ns	t_{PHL}^1 ; $R_{DIFF} = 54\Omega$, $C_{L1} = C_{L2} = 100pF$; Figures 3 & 7
Diff. Receiver Skew $ t_{PLH} - t_{PHL} $		13		ns	$R_{DIFF} = 54\Omega$; $C_{L1} = C_{L2} = 100pF$; Figures 3 & 7
POWER REQUIREMENTS					
Supply Voltage	+4.75		+5.25	Volts	
Supply Current		900		μA	
ENVIRONMENTAL AND MECHANICAL					
Operating Temperature					
Commercial (C)	0		+70	$^{\circ}C$	
Industrial (E)	-40		+85	$^{\circ}C$	
Storage Temperature	-65		+150	$^{\circ}C$	
Package					
Plastic DIP (P)					
NSOIC (N)					

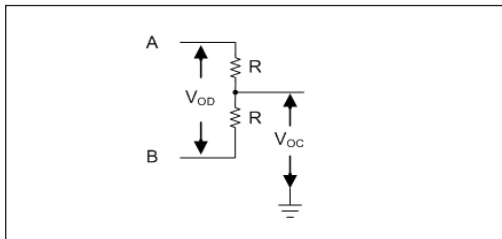

Figure 1. Driver DC Test Load Circuit

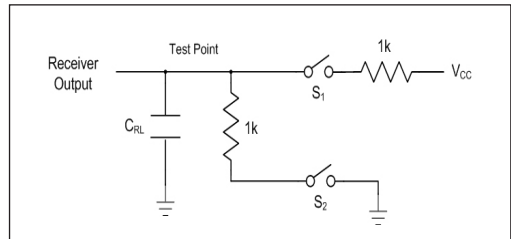

Figure 2. Receiver Timing Test Load Circuit

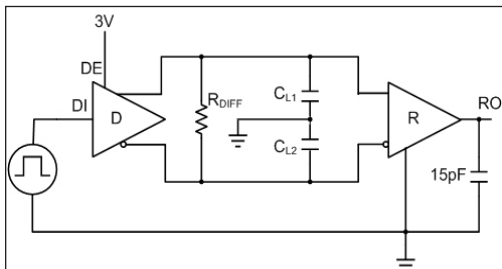

Figure 3. Driver/Receiver Timing Test Circuit

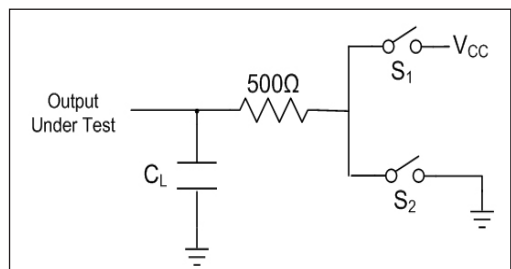

Figure 4. Driver Timing Test Load #2 Circuit

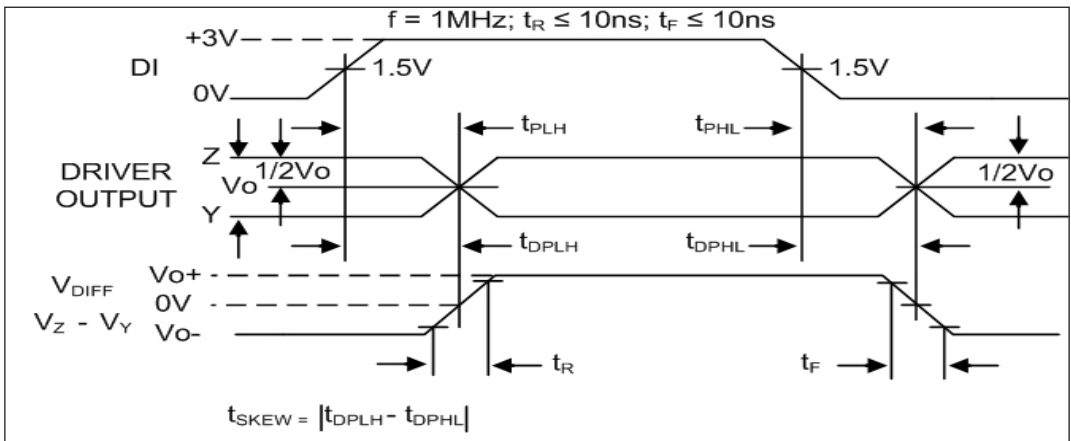

Figure 5. Driver Propagation Delays

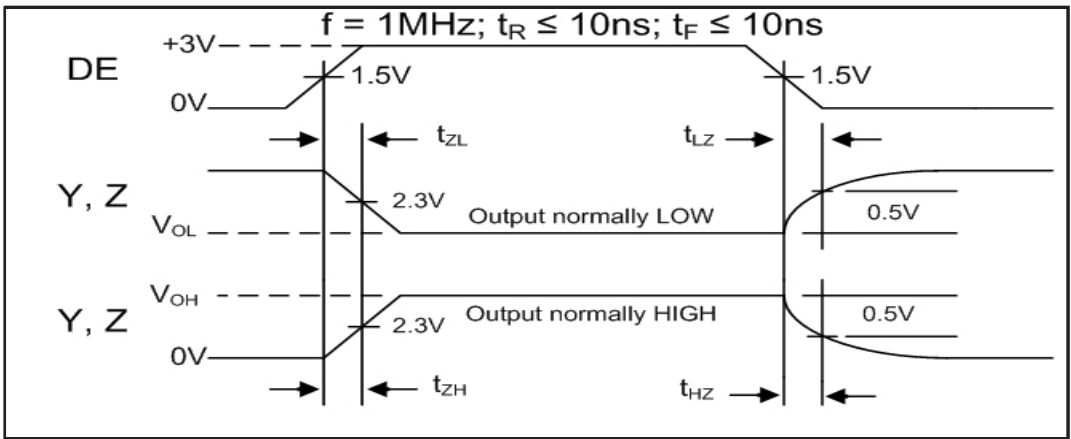

Figure 6. Driver Enable and Disable Times

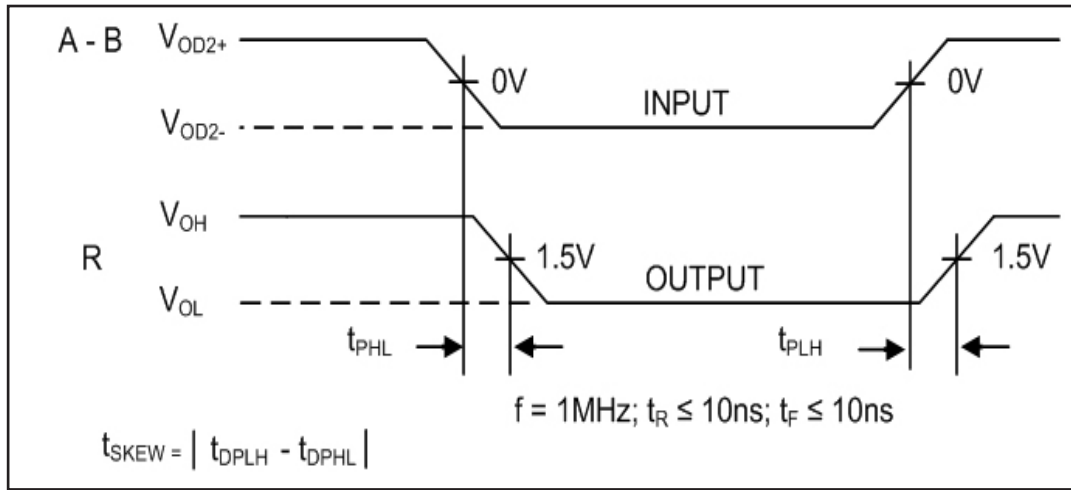

Figure 7. Receiver Propagation Delays

ABSOLUTE MAXIMUM RATINGS

These are stress ratings only and functional operation of the device at these ratings or any other above those indicated in the operation sections of the specifications below is not implied. Exposure to absolute maximum rating conditions for extended periods of time may affect reliability.

V _{CC}	+7V
Input Voltages	
Logic.....	-0.5V to (V _{CC} +0.5V)
Drivers.....	-0.5V to (V _{CC} +0.5V)
Receivers.....	±14V
Output Voltages	
Logic.....	-0.5V to (V _{CC} +0.5V)
Drivers.....	±14V
Receivers.....	-0.5V to (V _{CC} +0.5V)
Storage Temperature.....	-65°C to +150
Power Dissipation.....	1000mW

ELECTRICAL CHARACTERISTICS

T_{MIN} to T_{MAX} and V_{CC} = 5V ± 5% unless otherwise noted.

PARAMETERS	MIN.	TYP.	MAX.	UNITS	CONDITIONS
SP491E DRIVER					
DC Characteristics					
Differential Output Voltage	GND		V _{CC}	Volts	Unloaded; R = ∞ ; see figure 1
Differential Output Voltage	2		V _{CC}	Volts	With Load; R = 50Ω; (RS422); see figure 1
Differential Output Voltage	1.5		V _{CC}	Volts	With Load; R = 27Ω; (RS485); see figure 1
Change in Magnitude of Driver Differential Output Voltage for Complimentary States			0.2	Volts	R = 27Ω or R = 50Ω; see figure 1
Driver Common-Mode Output Voltage			3	Volts	R = 27Ω or R = 50Ω; see figure 1
Input High Voltage	2.0			Volts	Applies to D, \overline{RE} , DE
Input Low Voltage			0.8	Volts	Applies to D, \overline{RE} , DE
Input Current			±10	μA	Applies to D, \overline{RE} , DE
Driver Short-Circuit Current			250	mA	-7V ≤ V _O ≤ 12V
V _{OUT} = HIGH			250	mA	-7V ≤ V _O ≤ 12V
V _{OUT} = LOW					
SP491E DRIVER					
AC Characteristics					
Maximum Data Rate	10			Mbps	\overline{RE} = 5V, DE = 5V
Driver Input to Output	30	30	60	ns	t _{PLH} ; R _{DIFF} = 54Ω, C _{L1} = C _{L2} = 100pF; see figures 3 and 5
Driver Input to Output	30	30	60	ns	t _{FHL} ; R _{DIFF} = 54Ω, C _{L1} = C _{L2} = 100pF; see figures 3 and 5
Driver Skew	5	5	10	ns	t _{SKREW} = t _{DPLH} - t _{DPHL} ; From 10% to 90%; R _{DIFF} = 54Ω, C _{L1} = C _{L2} = 100pF; see figures 3 and 5
Driver Rise or Fall Time	15	15	40	ns	C _{L1} = C _{L2} = 100pF; see figures 4 and 6; S ₂ closed
Driver Enable to Output High	40	40	70	ns	C _{L1} = C _{L2} = 100pF; see figures 4 and 6; S ₁ closed
Driver Enable to Output Low	40	40	70	ns	C _{L1} = C _{L2} = 100pF; see figures 4 and 6; S ₁ closed
Driver Disable Time from Low	40	40	70	ns	C _{L1} = C _{L2} = 100pF; see figures 4 and 6; S ₁ closed
Driver Disable Time from High	40	40	70	ns	C _{L1} = C _{L2} = 100pF; see figures 4 and 6; S ₂ closed

ELECTRICAL CHARACTERISTICS

T_{MIN} to T_{MAX} and $V_{CC} = 5V \pm 5\%$ unless otherwise noted.

PARAMETERS	MIN.	TYP.	MAX.	UNITS	CONDITIONS
SP491E RECEIVER					
DC Characteristics					
Differential Input Threshold	-0.2		+0.2	Volts	$-7V \leq V_{CM} \leq 12V$
Input Hysteresis		70		mV	$V_{CM} = 0V$
Output Voltage High	3.5			Volts	$I_O = -4mA, V_{ID} = +200mV$
Output Voltage Low			0.4	Volts	$I_O = +4mA, V_{ID} = -200mV$
Three State (high impedance)					
Output Current			± 1	μA	$0.4V \leq V_O \leq 2.4V, \overline{RE} = 5V$
Input Resistance	12	15		k Ω	$-7V \leq V_{CM} \leq 12V$
Input Current (A, B); $V_{IN} = 12V$			± 1.0	mA	$DE = 0V, V_{CC} = 0V$ or $5.25V, V_{IN} = 12V$
Input Current (A, B); $V_{IN} = -7V$			-0.8	mA	$DE = 0V, V_{CC} = 0V$ or $5.25V, V_{IN} = -7V$
Short-Circuit Current			85	mA	$0V \leq V_O \leq V_{CC}$
SP491E RECEIVER					
AC Characteristics					
Maximum Data Rate	10			Mbps	$\overline{RE} = 0V$
Receiver Input to Output	20	45	100	ns	$t_{PLH}, R_{DIFF} = 54\Omega,$ $C_{L1} = C_{L2} = 100pF$; Figures 3 & 7
Receiver Input to Output	20	45	100	ns	$t_{PHL}, R_{DIFF} = 54\Omega,$ $C_{L1} = C_{L2} = 100pF$; Figures 3 & 7
Diff. Receiver Skew $ t_{PLH} - t_{PHL} $		13		ns	$R_{DIFF} = 54\Omega, C_{L1} = C_{L2} = 100pF$; Figures 3 & 7
Receiver Enable to Output Low		45	70	ns	$C_{RL} = 15pF$; Figures 2 and 8; S_1 closed
Receiver Enable to Output High		45	70	ns	$C_{RL} = 15pF$; Figures 2 and 8; S_2 closed
Receiver Disable from Low		45	70	ns	$C_{RL} = 15pF$; Figures 2 and 8; S_1 closed
Receiver Disable from High		45	70	ns	$C_{RL} = 15pF$; Figures 2 and 8; S_2 closed
POWER REQUIREMENTS					
Supply Voltage	+4.75		+5.25	Volts	
Supply Current		900		μA	$\overline{RE}, D = 0V$ or V_{CC} ; $DE = V_{CC}$
SP491E ENVIRONMENTAL AND MECHANICAL					
Operating Temperature					
Commercial (C_{C})	0		+70	$^{\circ}C$	
Industrial (E_{I})	-40		+85	$^{\circ}C$	
Storage Temperature	-65		+150	$^{\circ}C$	
Package					
Plastic DIP (P_{D})					
NSOIC (N_{I})					

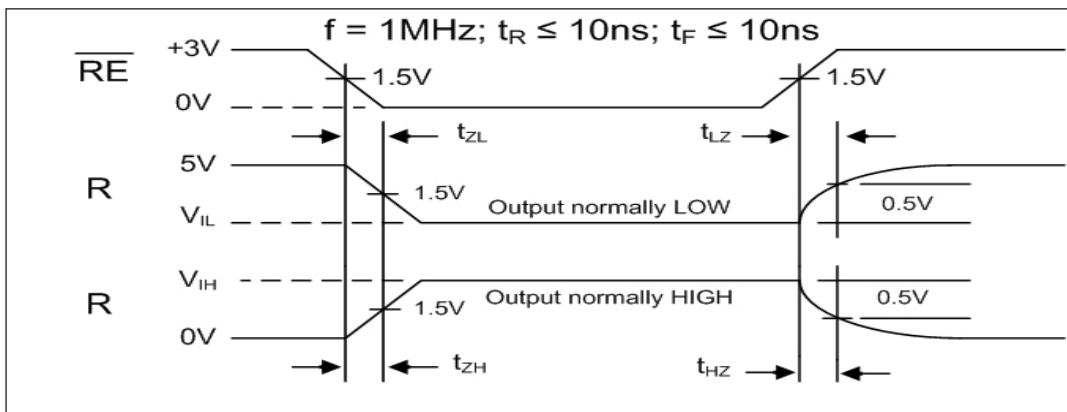

Figure 8. Receiver Enable and Disable Times

DESCRIPTION

The **SP490E** and **SP491E** are full-duplex differential transceivers that meet the requirements of RS-485 and RS-422. Fabricated with a **Exar** proprietary BiCMOS process, both products require a fraction of the power of older bipolar designs.

The RS-485 standard is ideal for multi-drop applications or for long-distance interfaces. RS-485 allows up to 32 drivers and 32 receivers to be connected to a data bus, making it an ideal choice for multi-drop applications. Since the cabling can be as long as 4,000 feet, RS-485 transceivers are equipped with a wide (-7V to +12V) common mode range to accommodate ground potential differences. Because RS-485 is a differential interface, data is virtually immune to noise in the transmission line.

Driver...

The drivers for both the **SP490E** and **SP491E** have differential outputs. The typical voltage output swing with no load will be 0 volts to +5 volts. With worst case loading of 54 Ω across the differential outputs, the driver can maintain greater than 1.5V voltage levels.

The driver of the **SP491E** has a driver enable control line which is active high. A logic high on DE (pin 4) of the **SP491E** will enable the differential driver outputs. A logic low on DE (pin 4) of the **SP491E** will tri-state the driver outputs. The **SP490E** does not have a driver enable.

Receiver...

The receivers for both the **SP490E** and **SP491E** have differential inputs with an input sensitivity as low as $\pm 200\text{mV}$. Input impedance of the receivers is typically 15k Ω (12k Ω minimum). A wide common mode range of -7V to +12V allows for large ground potential differences between systems. The receivers for both the **SP490E** and **SP491E** are equipped with the fail-safe feature. Fail-safe guarantees that the receiver output will be in a high state when the input is left unconnected.

The receiver of the **SP491E** has a receiver enable control line which is active low. A logic low on $\overline{\text{REB}}$ (pin 3) of the **SP491E** will enable the differential receiver. A logic high on REB (pin 3) of the **SP491E** will tri-state the receiver.

REVISION HISTORY			
REV.	DESCRIPTION	DATE	APP'D
A	DRAWING ORIGINATOR	08/16/05	JL
B	DRAWING FORMAT MODIFICATION	07/19/06	JL
C	CHANGE DRAWING LOGO AND COMPANY NAME	11/16/07	JL

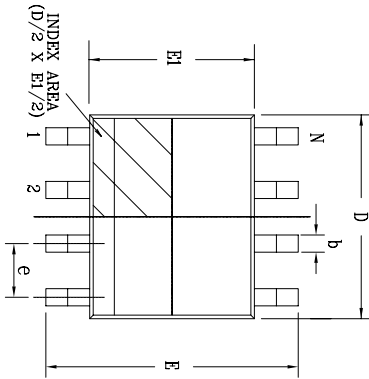

Top View

SYMBOLS	JEDEC MS-012			Variation AA		
	DIMENSIONS IN MM (Control Unit)			DIMENSIONS IN INCH (Reference Unit)		
	MIN	NOM	MAX	MIN	NOM	MAX
A	1.35	—	1.75	0.053	—	0.069
A1	0.10	—	0.25	0.004	—	0.010
A2	1.25	—	1.65	0.049	—	0.065
b	0.31	—	0.51	0.012	—	0.020
c	0.17	—	0.25	0.007	—	0.010
E	6.00 BSC			0.236 BSC		
E1	3.90 BSC			0.154 BSC		
e	0.25	—	0.50	0.010	—	0.020
h	0.40	—	1.27	0.016	—	0.050
L	1.04 REF			0.041 REF		
L2	0.25 BSC			0.010 BSC		
R	0.07	—	—	0.003	—	—
R1	0.07	—	—	0.003	—	—
θ	0°	—	8°	0°	—	8°
θ1	5°	—	15°	5°	—	15°
θ2	0°	—	—	0°	—	—
D	4.90 BSC			0.193 BSC		
N	8			8		

Side View

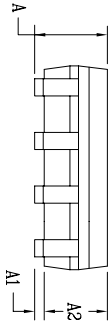

Front View

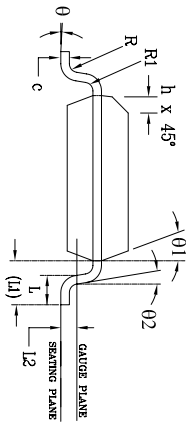

		EXAR CORPORATION Repeating Connectivity	
Packaging Approval:	By: JL Date: 11/16/07	Drawing No.:	Revision: C
		8-PIN NSOIC	Sheet: 1 OF 1

REVISION HISTORY			
REV.	DESCRIPTION	DATE	APP'D
A	DRAWING ORIGINATOR	04/17/06	JL
B	CHANGE DRAWING LOGO AND COMPANY NAME	11/21/07	JL

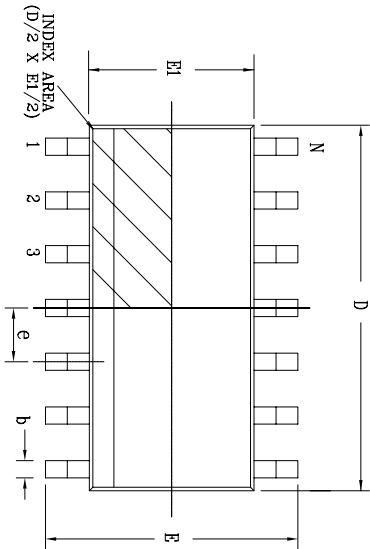

Top View

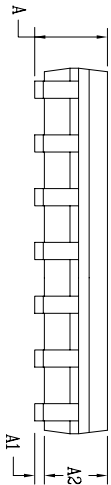

Side View

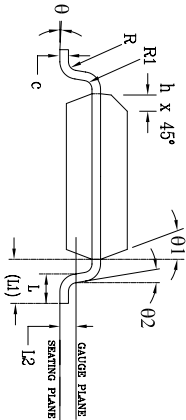

Front View

14 Pin SOICN		JEDEC MS-012		Variation AB		
SYMBOLS	DIMENSIONS IN MM (Control Unit)			DIMENSIONS IN INCH (Reference Unit)		
	MIN	NOM	MAX	MIN	NOM	MAX
A	1.35	—	1.75	0.053	—	0.069
A1	0.10	—	0.25	0.004	—	0.010
A2	1.25	—	1.65	0.049	—	0.065
b	0.31	—	0.51	0.012	—	0.020
c	0.17	—	0.25	0.007	—	0.010
E	6.00	BSC	—	0.236	BSC	—
E1	3.90	BSC	—	0.154	BSC	—
e	1.27	BSC	—	0.050	BSC	—
h	0.25	—	0.50	0.010	—	0.020
L	0.40	—	1.27	0.016	—	0.050
L1	—	1.04	REF	—	0.041	REF
L2	—	0.25	BSC	—	0.010	BSC
R	0.07	—	—	0.003	—	—
R1	0.07	—	—	0.003	—	—
theta	0°	—	8°	0°	—	8°
theta1	5°	—	15°	5°	—	15°
theta2	0°	—	—	0°	—	—
D	8.65	BSC	—	0.341	BSC	—
N	14	—	—	14	—	—

		EXAR CORPORATION Packaging Solutions	
Packaging Approver:	Br: JL	Drawing No:	Date: 11/21/07
14-PIN SOICN	Revision: B	Sheet: 1 OF 1	14-PIN SOICN

REMARKS:
FOR 8LD AND 16LD
ALL END LEADS (4X)
ARE HALF LEAD TYPES

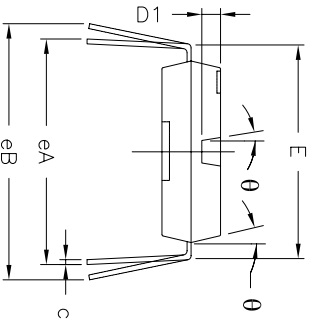
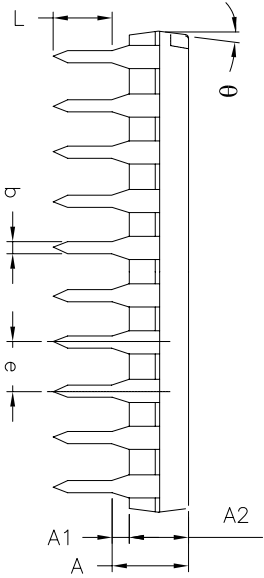
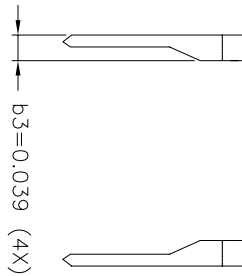
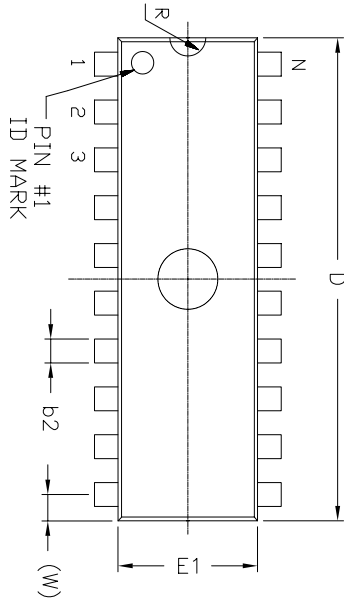

8 Pin PDIP JEDEC MS-001 Variation BA		DIMENSIONS IN INCH (Control Unit)				DIMENSIONS IN MM (Reference Unit)			
SYMBOLS	MIN	NOM	MAX	MIN	NOM	MAX			
A	—	—	0.210	—	—	5.33			
A1	0.015	—	—	0.38	—	—			
A2	0.115	0.130	0.195	2.92	3.30	4.95			
b	0.014	0.018	0.022	0.36	0.46	0.56			
b2	0.045	0.060	0.070	1.14	1.52	1.78			
c	0.008	0.010	0.014	0.20	0.25	0.36			
D1	0.030	—	0.060	0.76	—	1.52			
E	0.300	0.310	0.325	7.62	7.87	8.26			
E1	0.240	0.250	0.280	6.10	6.35	7.11			
e	0.100 BSC			2.54 BSC					
eA	0.300 BSC			7.62 BSC					
eB	—	—	0.430	—	—	10.92			
L	0.115	0.130	0.150	2.92	3.30	3.81			
W	0.075 REF		1.91 REF						
R	0.030 BSC			0.76 BSC					
theta	4°	7°	10°	4°	7°	10°			
D	0.355	0.365	0.400	9.02	9.27	10.16			
N	8			8					

REVISION HISTORY			
REV.	DESCRIPTION	DATE	APP'D
A	DRAWING ORIGINATOR	04/26/06	JL
B	CHANGE DRAWING LOGO AND COMPANY NAME	11/28/07	JL

		EXAR CORPORATION	
Packaging Approvals:		Drawing No.: 8-PIN PDIP PACKAGE OUTLINE	
Br: JL	Date: 11/28/07	Revision: B	Sheet: 1 OF 1

REMARKS:
FOR 8LD AND 16LD
ALL END LEADS (4X)
ARE HALF LEAD TYPES

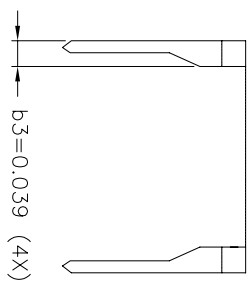
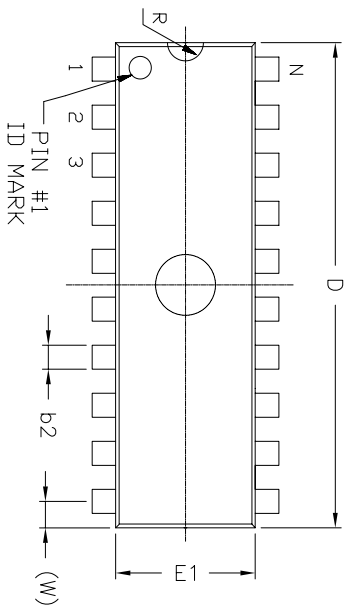

Top View

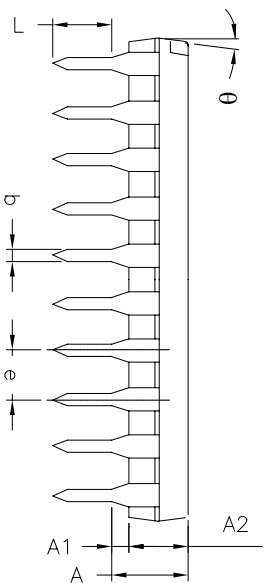

Side View

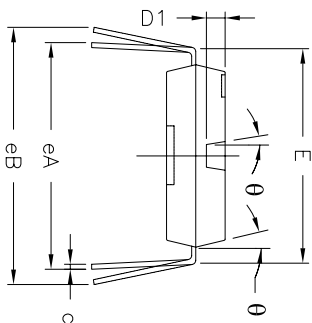

Front View

14 Pin PDIP JEDEC MS-001 Variation AA						
SYMBOLS	DIMENSIONS IN INCH (Control Unit)			DIMENSIONS IN MM (Reference Unit)		
	MIN	NOM	MAX	MIN	NOM	MAX
A	—	0.210	—	—	—	5.33
A1	0.015	—	0.38	—	—	—
A2	0.115	0.130	0.195	2.92	3.30	4.95
b	0.014	0.018	0.022	0.36	0.46	0.56
b2	0.045	0.060	0.070	1.14	1.52	1.78
c	0.008	0.010	0.014	0.20	0.25	0.36
D1	0.030	—	0.060	0.76	—	1.52
E	0.300	0.310	0.325	7.62	7.87	8.26
E1	0.240	0.250	0.280	6.10	6.35	7.11
e	0.100	BSC	—	2.54	BSC	—
eA	0.300	BSC	—	7.62	BSC	—
eB	—	0.430	—	—	10.92	—
L	0.115	0.130	0.150	2.92	3.30	3.81
W	0.075	REF	—	1.91	REF	—
R	0.030	BSC	—	0.76	BSC	—
theta	4°	7°	10°	4°	7°	10°
D	0.735	0.750	0.775	18.67	19.05	19.69
N	14	14	14	14	14	14

REVISION HISTORY			
REV.	DISCRIPTION	DATE	APP'D
A	DRAWING ORIGINATION	04/26/06	JL
B	CHANGE DRAWING LOGO AND COMPANY NAME	11/21/07	JL

		EXAR CORPORATION		
		14 PIN PDIP PACKAGE OUTLINE		
Packaging Approval:	By: JL	Date: 11/21/07	Revision: B	Sheet: 1 OF 1
Drawing No:	14-PIN PDIP			

Model	Temperature Range	Package
SP490ECN-L.....	0°C to +70°C	8-Pin NSOIC
SP490ECN-L/TR.....	0°C to +70°C	8-Pin NSOIC
SP490ECP-L.....	0°C to +70°C	8-Pin PDIP
SP490EEN-L.....	-40°C to +85°C	8-Pin NSOIC
SP490EEN-L/TR.....	-40°C to +85°C	8-Pin NSOIC
SP490EEP-L.....	-40°C to +85°C	8-Pin PDIP
SP491ECN-L.....	0°C to +70°C	14-Pin NSOIC
SP491ECN-L/TR.....	0°C to +70°C	14-Pin NSOIC
SP491ECP-L.....	0°C to +70°C	14-Pin PDIP
SP491EEN-L.....	-40°C to +85°C	14-Pin NSOIC
SP491EEN-L/TR.....	-40°C to +85°C	14-Pin NSOIC
SP491EEP-L.....	-40°C to +85°C	14-Pin PDIP

Note: /TR = Tape and Reel

REVISION HISTORY

Date	Revision	Description
2000	14	Sipex Legacy Data Sheet
May 2011	1.0.0	Convert to Exar format. Remove driver propagation delay minimum and driver rise/fall time minimum entry for SP490E and SP491E. Update ESD rating to IEC61000-4-2. Update ordering information.
May 2013	1.0.1	Correct type errors per PCN 13-0503-01 ECN: 1322-03 05/29/13

Notice

EXAR Corporation reserves the right to make changes to any products contained in this publication in order to improve design, performance or reliability. EXAR Corporation assumes no representation that the circuits are free of patent infringement. Charts and schedules contained herein are only for illustration purposes and may vary depending upon a user's specific application. While the information in this publication has been carefully checked; no responsibility, however, is assumed for inaccuracies.

EXAR Corporation does not recommend the use of any of its products in life support applications where the failure or malfunction of the product can reasonably be expected to cause failure of the life support system or to significantly affect its safety or effectiveness. Products are not authorized for use in such applications unless EXAR Corporation receives, in writing, assurances to its satisfaction that: (a) the risk of injury or damage has been minimized ; (b) the user assumes all such risks; (c) potential liability of EXAR Corporation is adequately protected under the circumstances.

Copyright 2013 EXAR Corporation

Datasheet May 2013

Send your serial transceiver technical inquiry with technical details to: serialtechsupport@exar.com

Reproduction, in part or whole, without the prior written consent of EXAR Corporation is prohibited.