

# Plastic Packaged Surface Mount Varactor Diodes

SMV1100, SMV1200, SMV1400 Series

## Features

- Industry Standard Outlines: SOD-323 and SOT SOT 23 Packages
- High "Q" Abrupt and Hyperabrupt Junction Designs
- Single and Common Cathode Configurations
- Available for 3 Volt Battery Operated Circuits
- Priced for High Volume Commercial Applications
- Available in Tape and Reel

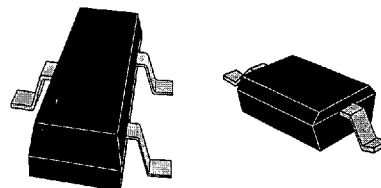

4

## Maximum Ratings (Ta = 25 °C)

Forward Current:	100 mA
Power Dissipation:	250 mW
Junction Temperature:	125 °C
Storage Temperature:	-55 to 150 °C
Operating Temperature:	-55 to 125 °C

## Description

The surface mount plastic varactor diodes are designed for RF and Microwave applications in VCOs, electronically tunable filters and matching networks. Package offerings include the SOT-23 and the small footprint SOD-323 package. Alpha offers a comprehensive capability in capacitance values, package options and voltage ratings all aggressively priced for high volume commercial applications.

The SMV1200-49 to SMV1200-55 varactors were specifically designed for battery operated applications where 3 to 5 volts is available. These varactors have capacitance ratios of greater than 12 from 0.3 to 4.7 volts.

Alpha's hyperabrupt varactors are available in a wide variety of tightly specified capacitance values and

high capacitance ratios. They are available as single junctions and common cathode configurations where they may be employed in a back-to-back orientation to reduce distortion.

Alpha's abrupt junction varactors are noted for extremely high Q factor and are the preferred choice in applications that require low phase noise and high temperature stability.





The inductance of the SOT-23 package is typically 1.5 nH for each junction. Employing a common cathode SOT-23 with the varactor junctions connected in parallel reduces the inductance to approximately 0.9 nH. The inductance of a varactor in the SOD-323 package is approximately 1.2 nH.

## SMV1100, SMV1200, SMV1400 Series

## Electrical Characteristics (TA = 25°C)

## High Ratio Hyperabrupt Junction Varactors for Battery Operated Applications

Breakdown Voltage, V<sub>b</sub> (10 μA), 15V MinReverse Leakage Current, I<sub>r</sub> (12V), 50 nA MaxCapacitance Ratio C<sub>T</sub> 0.3V/C<sub>T</sub> 3.0V, 7.8 Typical

				
Single	Single	Series	Common Anode	Common Cathode
SOD 323	SOT 23			

Part Number	C <sub>T</sub> @ 0.3V (pF)		C <sub>T</sub> @ 3.0V (pF)	C <sub>T</sub> @ 4.7V (pF)		C <sub>T</sub> 0.3V/C <sub>T</sub> 4.7V		R <sub>S</sub> @ 3V 50 MHz	Package Style (SOT 23)
	typ	min	typ	typ	max	typ	min	max (Ω)	
SMV1200-49 SMV1200-149	31	28	4.0	2.6	2.8	12.1	11.0	1	Single Common Cathode
SMV1200-50 SMV1200-150	36	33	4.5	3.0	3.3	12.2	11.0	0.9	Single Common Cathode
SMV1200-51 SMV1200-151	42	38	5.5	3.4	3.8	12.2	11.0	0.75	Single Common Cathode
SMV1200-53 SMV1200-153	53	48	6.7	4.3	4.8	12.3	11.0	0.6	Single Common Cathode
SMV1200-55 SMV1200-155	64	58	8.0	5.2	5.8	12.3	11.0	0.5	Single Common Cathode

## 12 Volt Hyperabrupt Junction Varactors for General Purpose

Reverse Breakdown Voltage, V<sub>BR</sub> (10 μA):

12V Minimum

Reverse Leakage Current, I<sub>R</sub> (8V):

50 nA Maximum

Part Number	C <sub>T</sub> @ 1V (pF)		C <sub>T</sub> @ 2.5V (pF)		C <sub>T</sub> @ 4V (pF)		Q @ 4V, 50 MHz	Package Style (SOT 23)
	min	typ	min	max	typ	max	min	
SMV1204-11	95	100	40	65	20	25	80	Single
SMV1204-12	42	50	18	27	9.0	12	150	Single
SMV1204-13	17	22	8.5	10.5	4.0	5.5	200	Single
SMV1204-14	14.5	16	6.5	7.8	3.0	4.8	300	Single
SMV1204-15	8.7	9.5	4.3	5.5	2.0	2.9	350	Single
SMV1201-97	85	-	-	-	15.0	30.0	500*	Single

\*Q @ 2V, F=1 MHz

Part Number	V <sub>B</sub> @ 10V	I <sub>R</sub> @ 8V (nA)	C <sub>T</sub> @ 0.2V (pF)		C <sub>T</sub> @ 2V (pF)		C <sub>T</sub> @ 6V, 50 MHz		Q @ 2V, 50 MHz	Package Style (SOT 23)
	min	max	min	max	min	max	min	max	min	
SMV1204-99 SMV1204-199	12	50	11	14	4	6.5	1.2	1.9	250	Single Common Cathode

Part Number	C <sub>T</sub> @ 2.5V (pF)		C <sub>T</sub> @ 1V/C <sub>T</sub> @ 2.5V		C <sub>T</sub> @ 2.5V/C <sub>T</sub> @ 4V (pF)		Q @ 4V, 50 MHz	Package Style (SOT 23)
	min	max	min	max	min	max	min	
SMV1204-22	18	27	1.5	2.0	1.5	2.0	150	Single
SMV1204-23	9	13	1.5	2.0	1.5	2.0	200	Single
SMV1204-24	6	8	1.5	2.0	1.5	2.0	300	Single
SMV1204-25	4.2	5.6	1.5	2.0	1.5	2.0	350	Single





## 15 Volt Hyperabrupt Junction Varactors

Reverse Breakdown Voltage,  $V_{BR}$  (10  $\mu$ A):

15V Minimum

Reverse Leakage Current,  $I_R$  (12V):

50 nA Maximum

				
Single	Single	Series	Common Anode	Common Cathode
SOD 323	SOT 23			

Part Number	$C_T$ @ 1V (pF)		$C_T$ (1V)/ $C_T$ (3V)		$C_T$ (1V)/ $C_T$ (6V)		$R_S$ @ 3V 50 MHz	Q @ 3V, 50 MHz	Package Style (SOT 23)
	min	max	min	max	min	max	max	min	
SMV1104-33 SMV1204-33 SMV1204-133	3.0	3.6	1.5	1.9	2.6	3.3	1.2	1200	Single SOD 323 Single Common Cathode
SMV1104-34 SMV1204-34 SMV1204-134	5.85	7.15	1.6	2.0	2.8	3.4	0.8	1000	Single SOD 323 Single Common Cathode
SMV1104-35 SMV1204-35 SMV1204-135	10.35	12.65	1.6	2.0	2.9	3.4	0.6	750	Single SOD 323 Single Common Cathode
SMV1104-36 SMV1204-36 SMV1204-136	15.50	18.50	1.6	2.0	3.0	3.5	0.5	700	Single SOD 323 Single Common Cathode
SMV1204-37	45.00	54.00	1.6	2.0	3.0	3.5	0.25	500	Single

## 20 Volt Hyperabrupt Junction Varactors for General Wide Band Applications

Reverse Breakdown Voltage,  $V_{BR}$  (10  $\mu$ A):

20V Minimum

Reverse Leakage Current,  $I_R$  (16V):

50 nA Maximum





Part Number	$C_T$ @ $V_{R1}$ (pF)		$V_{R1}$ (V)	$C_T$ @ $V_{R2}$ (pF)		$V_{R2}$ (V)	$C_T$ 1/ $C_T$ 2	Q @ $V_{R1}$ , 50 MHz	Package Style (SOT 23)
	min	max		min	max				
SMV1200-04 SMV1200-104	10.5	12.5	3	2.1	2.5	20	4.6	400	Single Common Cathode
SMV1200-07 SMV1200-107	25	31	3	4.5	5.3	20	4.8	300	Single Common Cathode
SMV1204-04 SMV1204-104	2.5	3.3	4	0.6	0.85	20	3.0	500	Single Common Cathode
SMV1204-05 SMV1204-105	4.5	5.5	4	0.9	1.2	20	4.2	500	Single Common Cathode
SMV1202-03	18	22	4	3.1	3.9	20	4.6	300	Single
SMV1202-08	45	55	4	7.3	9.2	20	5.0	200	Single
SMV1202-12	100	120	4	16	20	20	5.2	125	Single

0585443 0002643 050

**SMV1100, SMV1200, SMV1400 Series**

**Low Series Resistance Abrupt Junction Varactors**

Reverse Breakdown Voltage,  $V_{BR}$  (10  $\mu$ A): 12V Minimum  
 Reverse Leakage Current,  $I_r$  (10V): 50 nA Maximum

				
Single	Single	Series	Common Anode	Common Cathode
SOD 323	SOT 23			

Part Number	$C_T$ @ 1.0V (pF)		$C_T$ @ 4.0V (pF)		$R_S$ Max @ 1V, 50 MHz	Package Style (SOD 323)
	min	max	min	max	max	
SMV1401-99	17.4	20.0	10.0	12.1	0.25	Single SOD 323
SMV1401-98	36.3	41.7	20.7	25.3	0.20	Single SOD 323

**30 Volt Abrupt Junction Varactors For General Purpose**

Reverse Breakdown Voltage,  $V_{BR}$  (10  $\mu$ A): 30V Minimum  
 Reverse Leakage Current,  $I_R$  (24V): 50 nA Maximum

Part Number	$C_T$ @ 4V (pF)		$C_T 0/C_T 30$	$R_S$ @ 4V 50 MHz (Ohms)		Q @ 4V, 50 MHz	Package Style (SOT 23)
	min	max		min	max		
SMV1400-08 SMV1400-108	1.62	1.98	4.1	0.60	2900	Single Common Cathode	
SMV1400-09 SMV1400-109	1.98	2.42	4.1	0.50	2800	Single Common Cathode	
SMV1400-10 SMV1400-110	2.43	2.97	4.2	0.45	2600	Single Common Cathode	
SMV1400-11 SMV1400-111	2.97	3.63	4.2	0.40	2500	Single Common Cathode	
SMV1400-13 SMV1400-113	3.51	4.29	4.2	0.35	2400	Single Common Cathode	
SMV1400-14 SMV1400-114	4.23	5.17	4.2	0.30	2200	Single Common Cathode	
SMV1400-15 SMV1400-115	5.04	6.16	4.3	0.27	2100	Single Common Cathode	
SMV1400-16 SMV1400-116	6.12	7.48	4.3	0.24	2000	Single Common Cathode	
SMV1400-17 SMV1400-117	7.38	9.02	4.3	0.22	1800	Single Common Cathode	
SMV1400-19	9.00	11.00	4.4	0.20	1600	Single	
SMV1400-20	10.80	13.20	4.4	0.18	1500	Single	
SMV1400-21	13.50	16.50	4.4	0.18	1200	Single	
SMV1400-22	16.20	19.80	4.4	0.18	1000	Single	

- The outline 546-011 contains a single varactor junction in a two leaded SOD-323 package. The outline 434-043 contains a single varactor junction in a three leaded SOT-23 package. The outline 434-013 contains two varactor junctions in a common cathode configuration in a three leaded SOT-23 package.
- For part numbers designating two varactor junctions in a common cathode configuration, the listed electrical characteristics apply to a single junction.

0585443 0002644 T97

**Typical Performance Data**

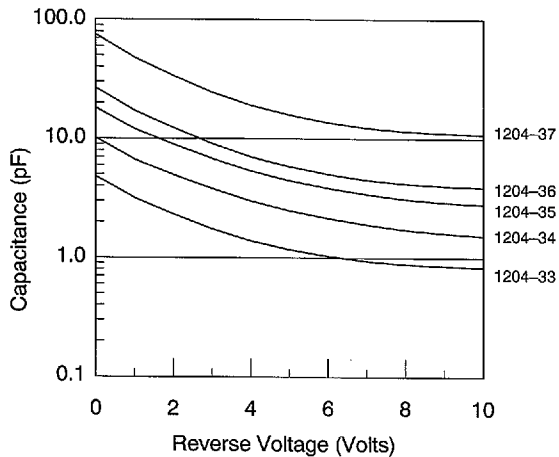

**Capacitance vs. Reverse Voltage**

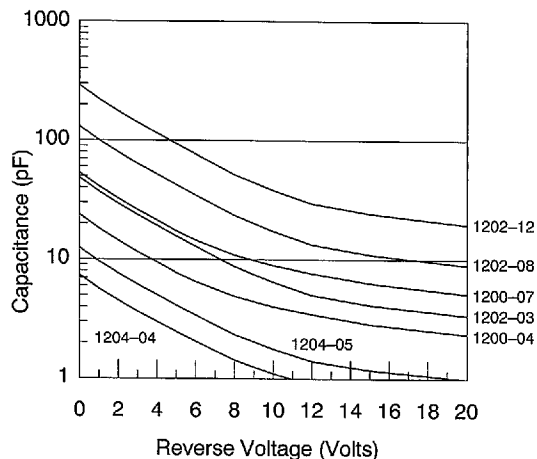

**Capacitance vs. Reverse Voltage**

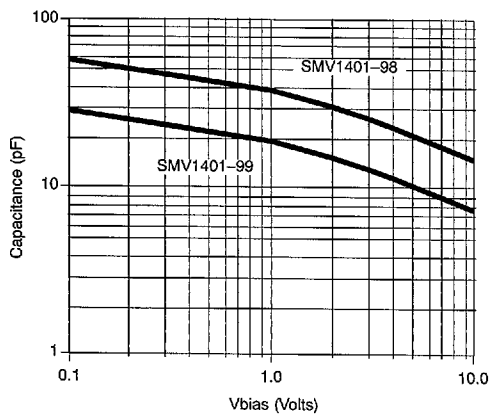

**Capacitance vs. Voltage**

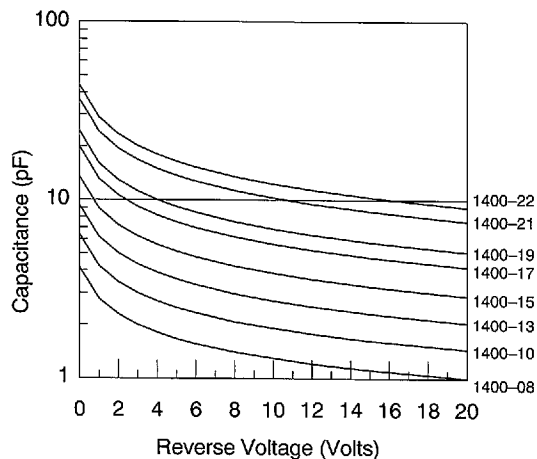

**Capacitance vs. Reverse Voltage**

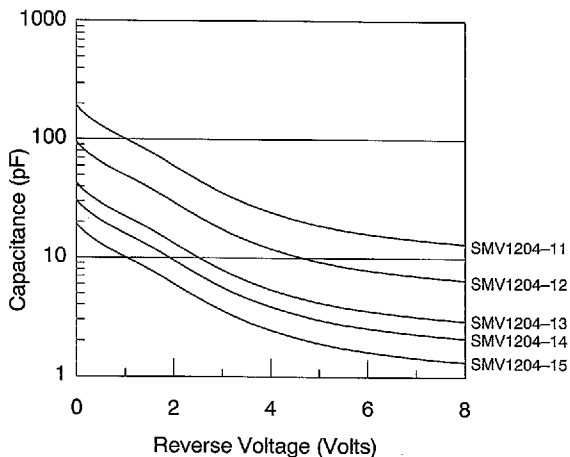

**Capacitance vs. Reverse Voltage**

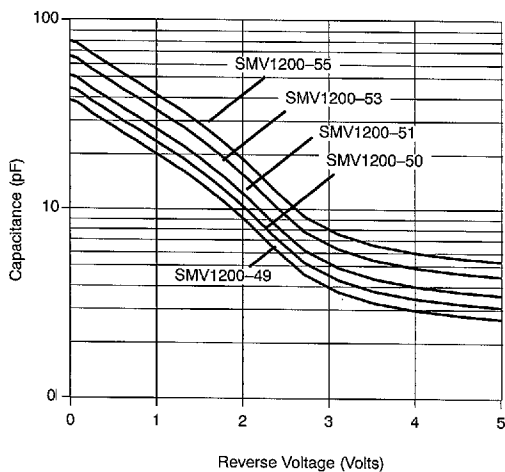

**Capacitance vs. Voltage**

**4**

0585443 0002645 923

### Outline Dimensions

#### SOT 23

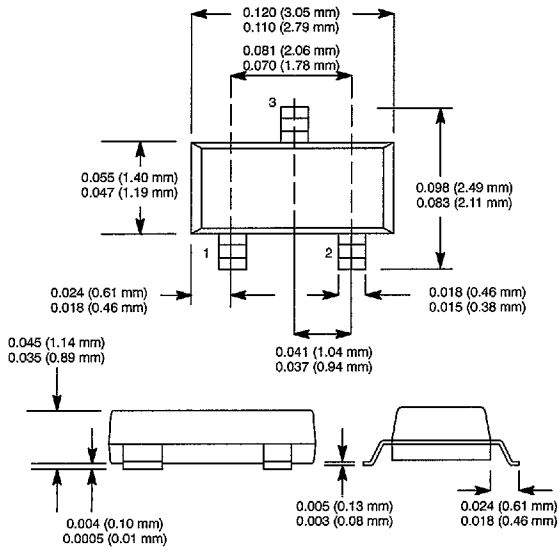

#### SOD 323

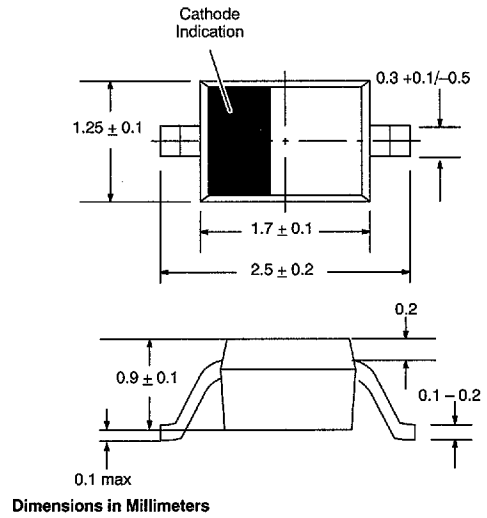

Dimensions in Millimeters

0585443 0002646 86T

# RF GaAs MMIC Products in Metal Packages

## Numerical Index

Part Number	Page	Part Number	Page	Part Number	Page
AD004T2-00	2-44	AK006R2-01	2-30	AS006M1-01	2-8
AD004T2-11	2-44	AK006R2-10	2-30	AS006M1-10	2-8
AE002M2-29	2-74	AK006R2-00	2-28	AS006M2-00	2-16
AE002M4-05	2-42	AK402D4-11	2-64	AS006M2-01	2-22
AH002R2-11	2-26	AK402D4-31	2-68	AS006M2-10	2-22
AK002D2-11	2-70	AN002M2-29	2-72	AS006R1-00	2-4
AK002D4-11	2-62	AN002M4-31	2-38	AS006R2-00	2-16
AK002D4-31	2-66	AN002M4-05	2-40	AS006R2-01	2-20
AK002M4-00	2-36	AS002M4-00	2-34	AS006R2-10	2-20
AK002M4-31	2-38	AS004L1-08	2-6	AS406M2-01	2-24
AK004L1-11	2-12	AS004L1-11	2-6	AS406R2-01	2-24
AK004M1-11	2-14	AS004L2-11	2-18	AT001D3-11	2-60
AK004M2-11	2-32	AS004M1-08	2-8	AT001D4-31	2-56
AK004R2-11	2-30	AS004M1-11	2-8	AT001D6-31	2-58
AK006L1-00	2-10	AS004M2-08	2-22	AT002D8-31	2-54
AK006L1-01	2-12	AS004M2-11	2-22	AT002N5-00	2-49
AK006L1-10	2-12	AS004R2-08	2-20	AT002N5-01	2-49
AK006M1-00	2-10	AS004R2-11	2-20	AT002N5-10	2-49
AK006M1-01	2-14	AS006L1-00	2-4	AT002N5-11	2-49
AK006M1-10	2-14	AS006L1-01	2-6	AT002S3-11	2-52
AK006M2-01	2-32	AS006L1-10	2-6	AT004N3-11	2-46
AK006M2-10	2-32	AS006L2-00	2-18	AT006N3-00	2-46
AK006M2-00	2-28	AS006L2-01	2-18	AT006N3-10	2-46
AK006R1-00	2-10	AS006M1-00	2-4	AT006N3-01	2-46

0585443 0002501 710