

DATA SHEET

SMV1129 and SMV1139: Hyperabrupt Junction Tuning Varactors

Features

- High Q
- Low series resistance for low phase noise
- Available in SOD-323 and SC-79
- Designed for high-volume commercial applications
- SPICE models are available
- Available lead (Pb)-free and RoHS-compliant MSL-1 @ 260 °C per JEDEC J-STD-020





Description

The SMV1129 and SMV1139 silicon hyperabrupt junction varactor diodes are designed for use in VCOs requiring low resistance. The low resistance of these varactors makes them appropriate for high Q resonators in wireless system VCOs to frequencies beyond 2.5 GHz.

NEW Skyworks offers lead (Pb)-free, RoHS (Restriction of Hazardous Substances)-compliant packaging.



	
Single	Single
SOD-323	SC-79
	SMV1129-079 Marking: Cathode
	SMV1129-079LF Marking: Cathode
SMV1139-011 Marking: CG	
SMV1139-011LF Marking: HG	
$L_S = 1.5 \text{ nH}$	$L_S = 0.7 \text{ nH}$

 LF denotes lead (Pb)-free, RoHS-compliant packaging option as an alternative to our standard tin/lead (Sn/Pb) packaging.

Absolute Maximum Ratings

Characteristic	Value
Forward current (I_F)	20 mA
Power dissipation (P_D)	250 mW
Storage temperature (T_{ST})	-55 °C to +150 °C
Operating temperature (T_{OP})	-55 °C to +125 °C
ESD human body model	Class 0

Performance is guaranteed only under the conditions listed in the specifications table and is not guaranteed under the full range(s) described by the Absolute Maximum specifications. Exceeding any of the absolute maximum/minimum specifications may result in permanent damage to the device and will void the warranty.

CAUTION: Although this device is designed to be as robust as possible, ESD (Electrostatic Discharge) can damage this device. This device must be protected at all times from ESD. Static charges may easily produce potentials of several kilovolts on the human body or equipment, which can discharge without detection. Industry-standard ESD precautions must be employed at all times.

Electrical Specifications at 25 °C

Part Number	C _T @ 1 V (pF)			C _T @ 1 V / C _T @ 3 V (Ratio)		C _T @ 1 V / C _T @ 6 V (Ratio)		R _S @ 1 V 500 MHz (Ω)
	Min.	Typ.	Max.	Min.	Typ.	Min.	Typ.	Max.
SMV1129	17.5	19	20.5	1.4	1.53	2	2.5	0.4
SMV1139	4.95	5.4	5.85	1.4	1.53	2	2.5	0.6

Reverse Voltage V_R (I_R = 10 μA): 12 V minimum.
 Reverse Current I_R (V_R = 10 V): 20 nA maximum.

Typical Performance Data

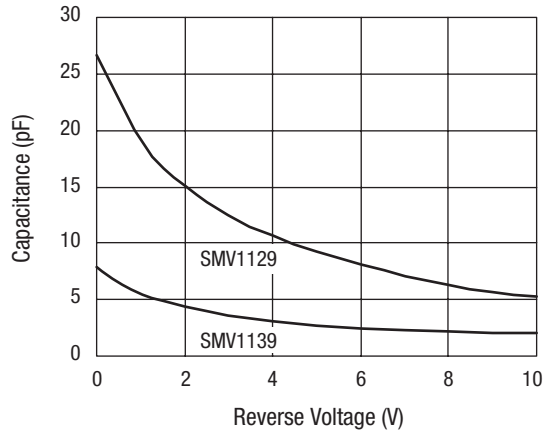

Capacitance vs. Reverse Voltage

Capacitance vs. Reverse Voltage

V _R (V)	SMV1129	SMV1139
	C _T (pF)	C _T (pF)
0	27.5	8
1	18.9	5.5
2	15	4.4
3	12.5	3.7
4	10.7	3.1
5	9.3	2.7
6	8.1	2.5
7	7.1	2.3
8	6.3	2.2
9	5.7	2.1
10	5.2	2
11	4.9	2
12	4.7	1.9

SPICE Model

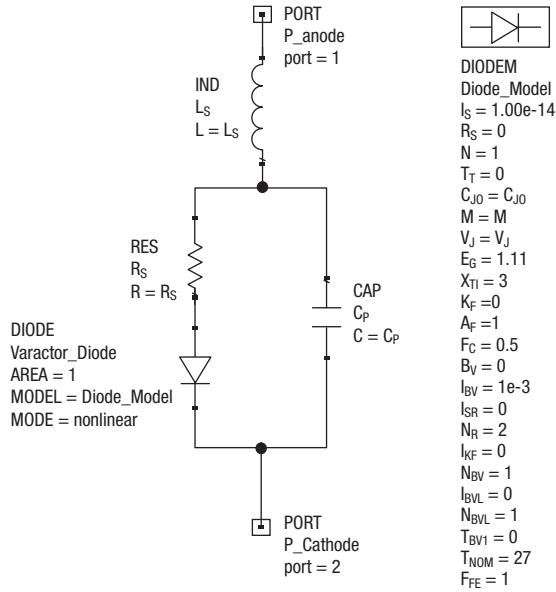

Part Number	C _{J0} (pF)	V _J (V)	M	C _P (pF)	R _S (Ω)
SMV1129	27.5	2.8	1.1	0	0.4
SMV1139	8	1.2	0.65	0	0.6

Values extracted from measured performance.
 For package inductance (L_S) refer to package type.
 For more details refer to the "Varactor SPICE Models for RF VCO Applications" Application Note.

Recommended Solder Reflow Profiles

Refer to the ["Recommended Solder Reflow Profile"](#) Application Note.

Tape and Reel Information

Refer to the ["Discrete Devices and IC Switch/Attenuators Tape and Reel Package Orientation"](#) Application Note.

SOD-323

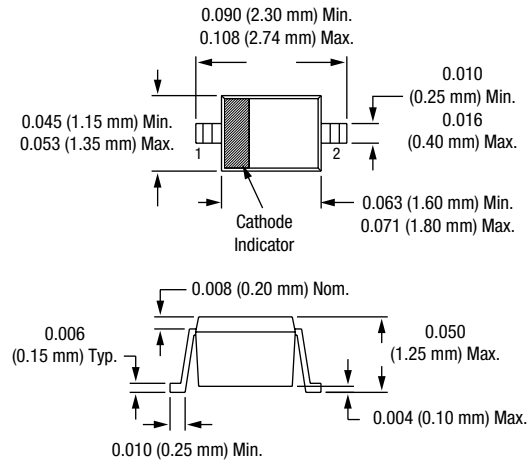

SC-79

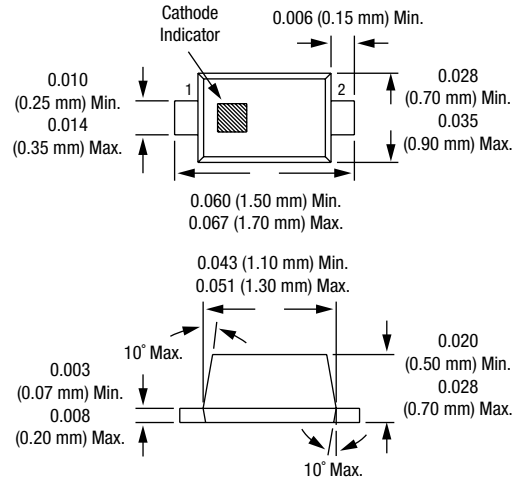

Copyright © 2002, 2003, 2004, 2005, Skyworks Solutions, Inc. All Rights Reserved.

Information in this document is provided in connection with Skyworks Solutions, Inc. ("Skyworks") products or services. These materials, including the information contained herein, are provided by Skyworks as a service to its customers and may be used for informational purposes only by the customer. Skyworks assumes no responsibility for errors or omissions in these materials or the information contained herein. Skyworks may change its documentation, products, services, specifications or product descriptions at any time, without notice. Skyworks makes no commitment to update the materials or information and shall have no responsibility whatsoever for conflicts, incompatibilities, or other difficulties arising from any future changes.

No license, whether express, implied, by estoppel or otherwise, is granted to any intellectual property rights by this document. Skyworks assumes no liability for any materials, products or information provided hereunder, including the sale, distribution, reproduction or use of Skyworks products, information or materials, except as may be provided in Skyworks Terms and Conditions of Sale.

THE MATERIALS, PRODUCTS AND INFORMATION ARE PROVIDED "AS IS" WITHOUT WARRANTY OF ANY KIND, WHETHER EXPRESS, IMPLIED, STATUTORY, OR OTHERWISE, INCLUDING FITNESS FOR A PARTICULAR PURPOSE OR USE, MERCHANTABILITY, PERFORMANCE, QUALITY OR NON-INFRINGEMENT OF ANY INTELLECTUAL PROPERTY RIGHT; ALL SUCH WARRANTIES ARE HEREBY EXPRESSLY DISCLAIMED. SKYWORKS DOES NOT WARRANT THE ACCURACY OR COMPLETENESS OF THE INFORMATION, TEXT, GRAPHICS OR OTHER ITEMS CONTAINED WITHIN THESE MATERIALS. SKYWORKS SHALL NOT BE LIABLE FOR ANY DAMAGES, INCLUDING BUT NOT LIMITED TO ANY SPECIAL, INDIRECT, INCIDENTAL, STATUTORY, OR CONSEQUENTIAL DAMAGES, INCLUDING WITHOUT LIMITATION, LOST REVENUES OR LOST PROFITS THAT MAY RESULT FROM THE USE OF THE MATERIALS OR INFORMATION, WHETHER OR NOT THE RECIPIENT OF MATERIALS HAS BEEN ADVISED OF THE POSSIBILITY OF SUCH DAMAGE.

Skyworks products are not intended for use in medical, lifesaving or life-sustaining applications, or other equipment in which the failure of the Skyworks products could lead to personal injury, death, physical or environmental damage. Skyworks customers using or selling Skyworks products for use in such applications do so at their own risk and agree to fully indemnify Skyworks for any damages resulting from such improper use or sale.

Customers are responsible for their products and applications using Skyworks products, which may deviate from published specifications as a result of design defects, errors, or operation of products outside of published parameters or design specifications. Customers should include design and operating safeguards to minimize these and other risks. Skyworks assumes no liability for applications assistance, customer product design, or damage to any equipment resulting from the use of Skyworks products outside of stated published specifications or parameters.

Skyworks, the Skyworks symbol, and "Breakthrough Simplicity" are trademarks or registered trademarks of Skyworks Solutions, Inc., in the United States and other countries. Third-party brands and names are for identification purposes only, and are the property of their respective owners. Additional information, including relevant terms and conditions, posted at www.skyworksinc.com, are incorporated by reference.