

Dual 4-Stage Static Shift Register

High-Voltage Silicon-Gate CMOS

The SL4015B consists of two identical, independent, 4-stage serial-input/parallel-output registers. Each register has independent CLOCK and RESET inputs as well as a single serial DATA input. "Q" outputs are available from each of the four stages on both registers. All register stages are D-type, master-slave flip-flops. The logic level present at the DATA input is transferred into the first register stage and shifted over one stage at each positive-going clock transition. Resetting of all stages is accomplished by a high level on the reset line. Register expansion to 8 stages using one SL4015B package, or to more than 8 stages using additional SL4015B's is possible.

- Operating Voltage Range: 3.0 to 18 V
- Maximum input current of 1 μ A at 18 V over full package-temperature range; 100 nA at 18 V and 25°C
- Noise margin (over full package temperature range):
 - 1.0 V min @ 5.0 V supply
 - 2.0 V min @ 10.0 V supply

LOGIC DIAGRAM

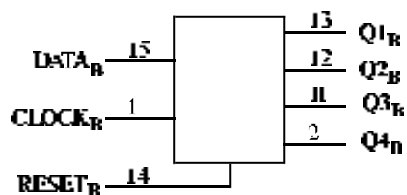
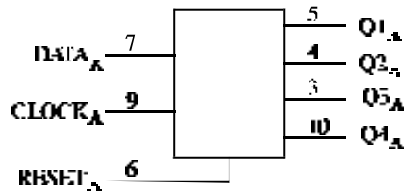

PIN 16 = V_{CC}
PIN 8 = GND

2.5 V min @ 15.0 V supply

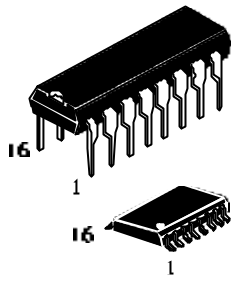

16

1

16

1

H SUFFIX
PLASTIC

D SUFFIX
SOIC

ORDERING INFORMATION

SL4015BN Plastic

SL4015BD SOIC

T_A = -55° to 125° C for all packages

PIN ASSIGNMENT

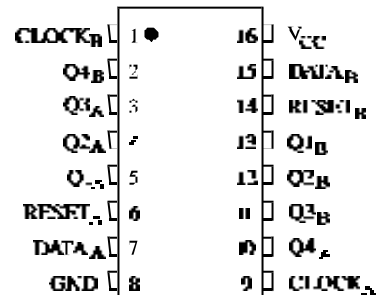

FUNCTION TABLE

Inputs			Outputs	
Clock	Data	Reset	Q1	Q _n
	L	L	L	Q _{n-1}
	H	L	H	Q _{n-1}
	X	L	No change	
X	X	H	L	L

X = don't care

MAXIMUM RATINGS*

Symbol	Parameter	Value	Unit
V _{CC}	DC Supply Voltage (Referenced to GND)	-0.5 to +20	V
V _{IN}	DC Input Voltage (Referenced to GND)	-0.5 to V _{CC} +0.5	V
V _{OUT}	DC Output Voltage (Referenced to GND)	-0.5 to V _{CC} +0.5	V
I _{IN}	DC Input Current, per Pin	±10	mA
P _D	Power Dissipation in Still Air, Plastic DIP+ SOIC Package+	750 500	mW
P _D	Power Dissipation per Output Transistor	100	mW
T _{stg}	Storage Temperature	-65 to +150	°C
T _L	Lead Temperature, 1 mm from Case for 10 Seconds (Plastic DIP or SOIC Package)	260	°C

*Maximum Ratings are those values beyond which damage to the device may occur.
Functional operation should be restricted to the Recommended Operating Conditions.

+Derating - Plastic DIP: - 10 mW/°C from 65° to 125°C
SOIC Package: - 7 mW/°C from 65° to 125°C

RECOMMENDED OPERATING CONDITIONS

Symbol	Parameter	Min	Max	Unit
V _{CC}	DC Supply Voltage (Referenced to GND)	3.0	18	V
V _{IN} , V _{OUT}	DC Input Voltage, Output Voltage (Referenced to GND)	0	V _{CC}	V
T _A	Operating Temperature, All Package Types	-55	+125	°C

This device contains protection circuitry to guard against damage due to high static voltages or electric fields. However, precautions must be taken to avoid applications of any voltage higher than maximum rated voltages to this high-impedance circuit. For proper operation, V_{IN} and V_{OUT} should be constrained to the range $GND \leq (V_{IN} \text{ or } V_{OUT}) \leq V_{CC}$.

Unused inputs must always be tied to an appropriate logic voltage level (e.g., either GND or V_{CC}). Unused outputs must be left open.



SL4015B

DC ELECTRICAL CHARACTERISTICS (Voltages Referenced to GND)

Symbol	Parameter	Test Conditions	V _{CC} V	Guaranteed Limit			Unit
				≥-55°C	25°C	≤125°C	
V _{IH}	Minimum High-Level Input Voltage	V _{OUT} = 0.5 V or V _{CC} - 0.5V V _{OUT} = 1.0 V or V _{CC} - 1.0 V V _{OUT} = 1.5 V or V _{CC} - 1.5V	5.0	3.5	3.5	3.5	V
			10	7	7	7	
			15	11	11	11	
V _{IL}	Maximum Low -Level Input Voltage	V _{OUT} = 0.5 V or V _{CC} - 0.5V V _{OUT} = 1.0 V or V _{CC} - 1.0 V V _{OUT} = 1.5 V or V _{CC} - 1.5V	5.0	1.5	1.5	1.5	V
			10	3	3	3	
			15	4	4	4	
V _{OH}	Minimum High-Level Output Voltage	V _{IN} =GND or V _{CC}	5.0	4.95	4.95	4.95	V
			10	9.95	9.95	9.95	
			15	14.95	14.95	14.95	
V _{OL}	Maximum Low-Level Output Voltage	V _{IN} =GND or V _{CC}	5.0	0.05	0.05	0.05	V
			10	0.05	0.05	0.05	
			15	0.05	0.05	0.05	
I _{IN}	Maximum Input Leakage Current	V _{IN} = GND or V _{CC}	18	±0.1	±0.1	±1.0	μA
I _{CC}	Maximum Quiescent Supply Current (per Package)	V _{IN} = GND or V _{CC}	5.0	5	5	150	μA
			10	10	10	300	
			15	20	20	600	
			20	100	100	3000	
I _{OL}	Minimum Output Low (Sink) Current	V _{IN} = GND or V _{CC} U _{OL} =0.4 V U _{OL} =0.5 V U _{OL} =1.5 V	5.0	0.64	0.51	0.36	mA
			10	1.6	1.3	0.9	
			15	4.2	3.4	2.4	
I _{OH}	Minimum Output High (Source) Current	V _{IN} = GND or V _{CC} U _{OH} =2.5 V U _{OH} =4.6 V U _{OH} =9.5 V U _{OH} =13.5 V	5.0	-2	-1.6	-1.15	mA
			5.0	-0.64	-0.51	-0.36	
			10	-1.6	-1.3	-0.9	
			15	-4.2	-3.4	-2.4	

AC ELECTRICAL CHARACTERISTICS ($C_L=50\text{pF}$, $R_L=200\text{k}\Omega$, Input $t_r=t_f=20\text{ ns}$)

Symbol	Parameter	V_{CC} V	Guaranteed Limit			Unit
			$\geq -55^\circ\text{C}$	25°C	$\leq 125^\circ\text{C}$	
t_{max}	Maximum Clock Frequency (Figure 1)	5.0	3	3	1.5	MHz
		10	6	6	3	
		15	8.5	8.5	4.25	
t_{PHL}, t_{PLH}	Maximum Propagation Delay, Clock to Q (Figure 1)	5.0	320	320	640	ns
		10	160	160	320	
		15	120	120	240	
t_{PHL}	Maximum Propagation Delay, Reset to Q (Figure 2)	5.0	400	400	800	ns
		10	200	200	400	
		15	160	160	320	
t_{THL}, t_{TLH}	Maximum Output Transition Time, Any Output (Figure 1)	5.0	200	200	400	ns
		10	100	100	200	
		15	80	80	160	
C_{IN}	Maximum Input Capacitance	-		7.5		pF

TIMING REQUIREMENTS ($C_L=50\text{pF}$, $R_L=200\text{ k}\Omega$, Input $t_r=t_f=20\text{ ns}$)

Symbol	Parameter	V_{CC} V	Guaranteed Limit			Unit
			$\geq -55^\circ\text{C}$	25°C	$\leq 125^\circ\text{C}$	
t_w	Minimum Pulse Width, Clock (Figure 1)	5.0	180	180	360	ns
		10	80	80	160	
		15	50	50	100	
t_w	Minimum Pulse Width, Reset (Figure 2)	5.0	200	200	400	ns
		10	80	80	160	
		15	60	60	120	
t_{su}	Minimum Setup Time, Data to Clock (Figure 3)	5.0	70	70	140	ns
		10	40	40	80	
		15	30	30	60	
t_h	Minimum Hold Time, Clock to Data (Figure 3)	5.0	0	0	0	ns
		10	0	0	0	
		15	0	0	0	
t_r, t_f	Maximum Input Rise and Fall Time (Figure 1)	5.0	15	15	30	μs
		10	6	6	12	
		15	2	2	4	



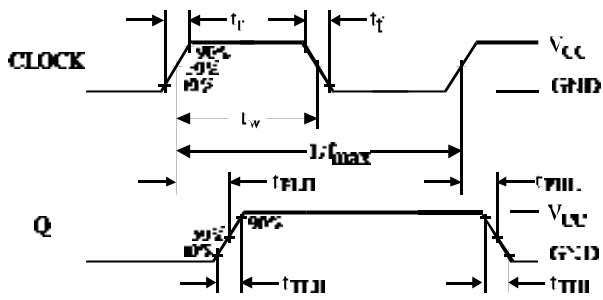

Figure 1. Switching Waveforms

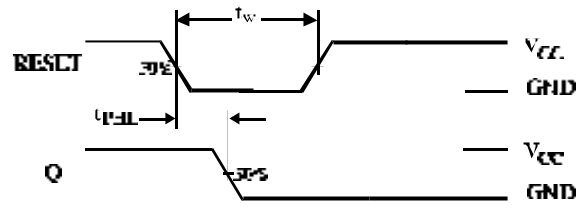

Figure 2. Switching Waveforms

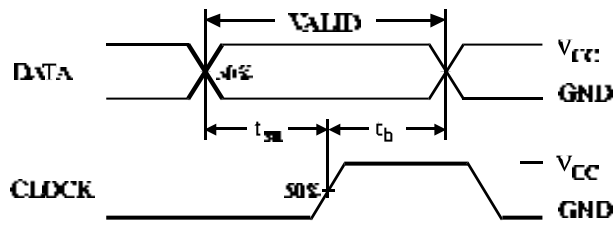

Figure 3. Switching Waveforms

EXPANDED LOGIC DIAGRAM (1/2 of the Device)

