

RoHS Compliant Product
A suffix of "-C" specifies halogen free

DESCRIPTION

The SJ1084 is a low drop voltage regulator able to provide up to 5A output current. The dropout voltage of the device is guaranteed at a maximum 1.5V at the maximum output current, decreasing at lower loads.

The SJ1084 is pin compatible with older 3-terminal adjustable regulators, but has better performances in term of drop and output tolerance.

FEATURES

- Typical Dropout 1.3V (at 5A)
- Output Tolerance: $\pm 2\%$ at 25°C
- Wind Operating Temperature Range: -40°C to 125°C

APPLICATIONS

- Post Regulators for Switching Supply
- Battery-Powered Circuitry
- Low Voltage Logic Supplies
- igh efficiency linear regulators

TO-252 (D-Pack)

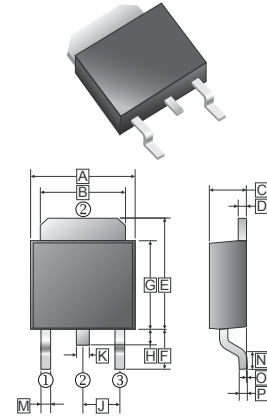

REF.	Millimeter		REF.	Millimeter	
	Min.	Max.		Min.	Max.
A	6.35	6.90	J	2.30	REF.
B	4.95	5.50	K	0.64	1.14
C	2.10	2.50	M	0.50	1.14
D	0.43	0.9	N	1.3	1.8
E	6.0	7.5	O	0	0.13
F	2.80	REF.	P	0.58	REF.
G	5.40	6.40			
H	0.60	1.20			

MARKING

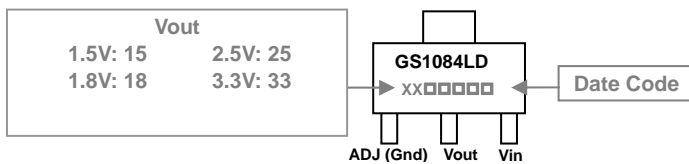

TYPICAL CIRCUIT

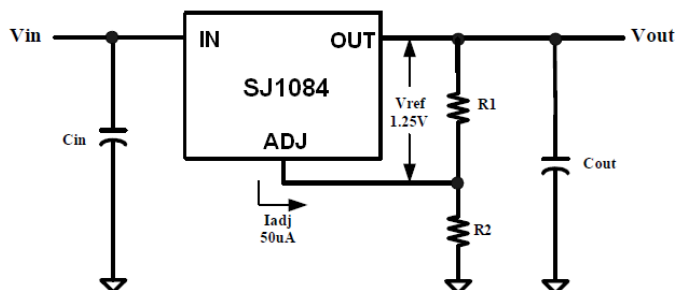

$$V_{OUT} = V_{REF} (1 + R2/R1) + I_{ADJ} R2$$

Figure1. Adjustable Voltage Regulator

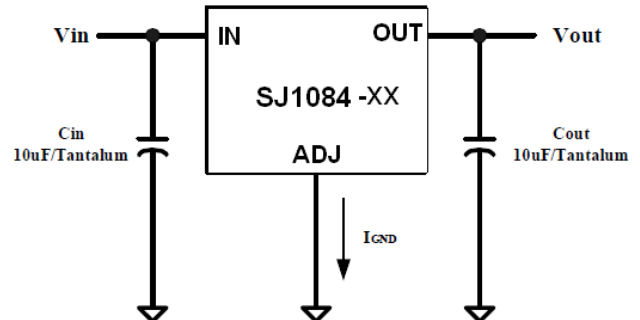
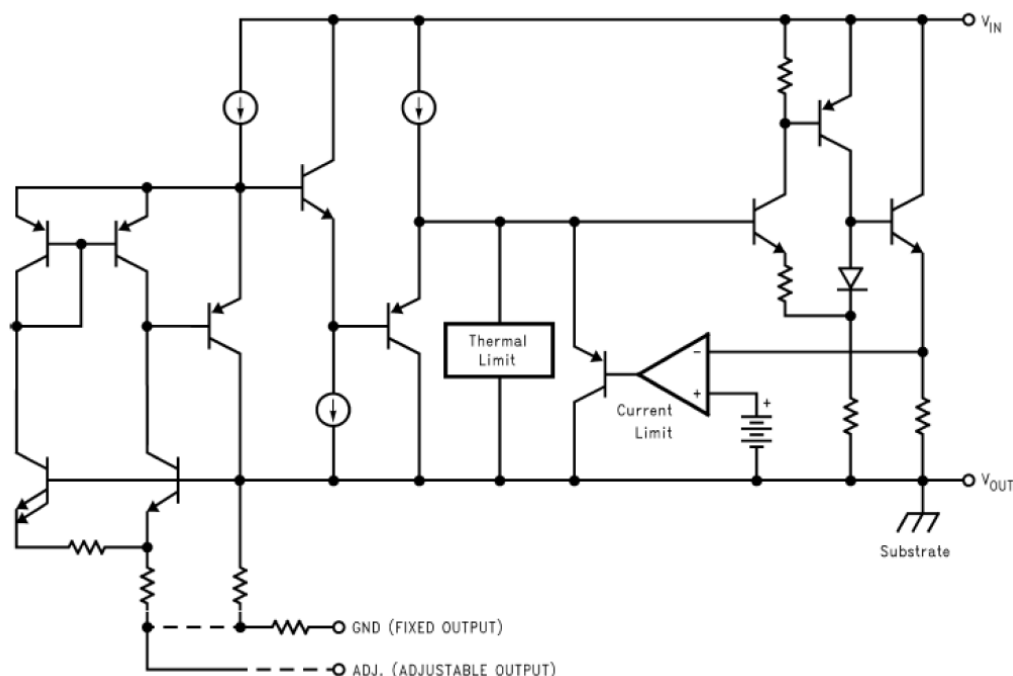

Figure2. Fixed Voltage Regulator

LOCK DIAGRAM



PIN DESCRIPTIONS

Name	I/O	Pin#	Description
ADJ / Gnd		1	A resistor divider from this pin to the V _{OUT} pin and ground sets the output voltage (Ground only for fixed mode)
V _{OUT}	O	2	The output pin of regulator. A min. of 10µF capacitor must be connected from this pin to ground to insure stability.
V _{IN}	I	3	The input pin of regulator. Typically a large storage capacitor is connected from this pin to ground to insure that the input voltage does not sag below the min. dropout voltage during the load transient response. This pin must always be 1.3V higher than V _{OUT} in order for the device to regulate properly.

ABSOLUTE MAXIMUM RATINGS

Parameter	Symbol	Ratings	Unit
DC Supply Voltage	V _{in}	15	V
Power Dissipation	P _D	1.2	W
Thermal Resistance (Junction to Case)	R _{θJC}	5	°C/W
Thermal Resistance (Junction to Ambient)	R _{θJA}	104	°C/W
Operating, Storage Temperature Range	T _J , T _{STG}	-40~125, -65~150	°C
Lead Temperature (Soldering 10sec)	T _{LEAD}	300	°C

Note:

1. Stress above the listed absolute maximum rating may cause permanent damage to the device

ELECTRICAL CHARACTERISTICS

Parameter	Test Conditions		Min.	Typ.	Max	Unit
Reference Voltage ¹	SJ1084-ADJ	$V_{IN}=2.75V, I_o=10mA$	1.238	1.25	1.263	V
		$I_o=10mA\sim 5A, V_{IN}=2.7V\sim 7V$	1.225	1.25	1.275	
Output Voltage	SJ1084-1.5	$V_{IN}=4V$	1.485	1.5	1.515	V
		$V_{IN}=3V, I_o=0\sim 5A$	1.47	1.5	1.53	
	SJ1084-1.8	$V_{IN}=4.3V$	1.782	1.8	1.818	V
		$V_{IN}=3.3V, I_o=0\sim 5A$	1.764	1.8	1.836	
	SJ1084-2.5	$V_{IN}=5V$	2.475	2.5	2.525	V
		$V_{IN}=4V, I_o=0\sim 5A$	2.45	2.5	2.55	
	SJ1084-3.3	$V_{IN}=5.8V$	3.267	3.3	3.333	V
		$V_{IN}=4.8V, I_o=0\sim 5A$	3.234	3.3	3.366	
Line Regulation ¹	All	$I_o=10mA, (V_{out}+1.5V)\leq V_{IN}\leq 7V$	-	0.04	0.2	%
Load Regulation ¹	All	$V_{IN}=V_o+2.5V, I_o=0\sim 5A$	-	0.08	0.4	%
Dropout Voltage ^{1,3} ($V_{IN}-V_{OUT}$)	All	$I_{out}=5A, \Delta V_{out}, \Delta V_{REF}=1\%$	-	1.1	1.3	V
Current Limit ¹	All		-	5.5	-	A
Quiescent Current	All	$V_{IN}=5V$	-	5	10	mA
Ripple Rejection ¹	All	$F=120Hz, C_{OUT}=25\mu F$ Tantalum, $I_{OUT}=3A,$ $V_{IN}-V_{OUT}=3V, C_{ADJ}=25\mu F$	60	75	-	dB
Temperature Stability			-	0.5	-	%
Long Term Stability	$T_A=12.5^\circ C, 1000Hrs$		-	0.03	1	%

Note:

1. For SJ1084(adjustable) $V_{ADJ}=0V$
2. For the adjustable device the minimum load current is the minimum current required to maintain regulation. Normally the current in the resistor divider used to set the output voltage is selected to meet the minimum load current requirement.
3. The specification represent the minimum input/output voltage required to maintain 1% regulation.

CHARACTERISTIC CURVES

Dropt Voltage

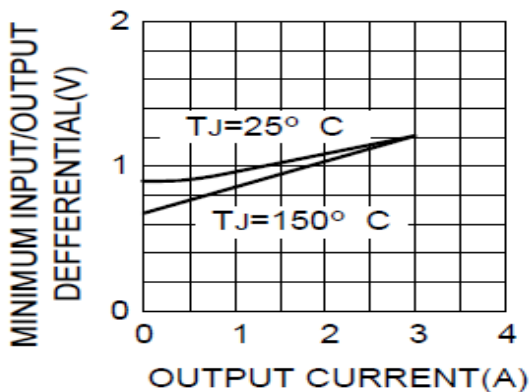

Load Regulation

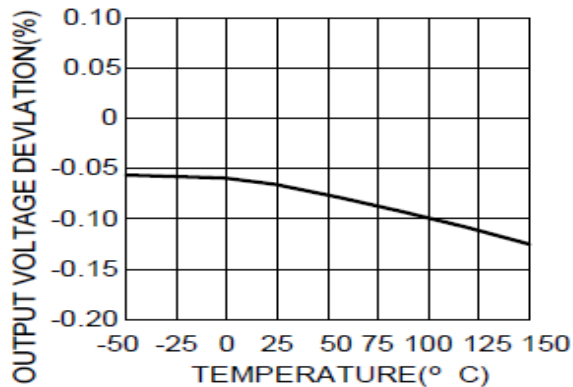

Temperature Stability

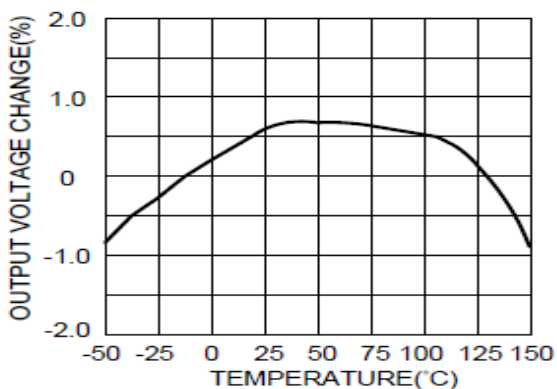

Ripple Rejection

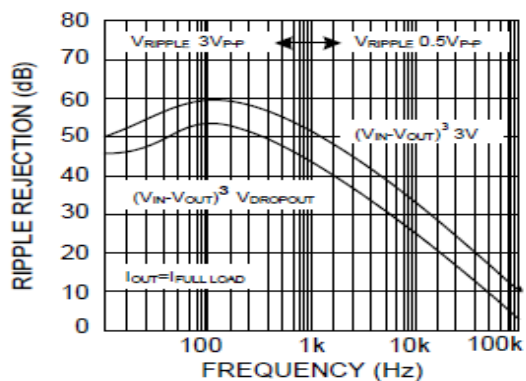

Ripple Rejection vs. Current

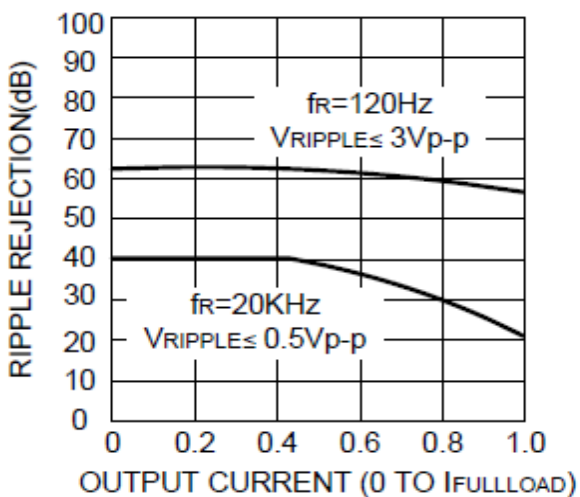

Short-Circuit Current

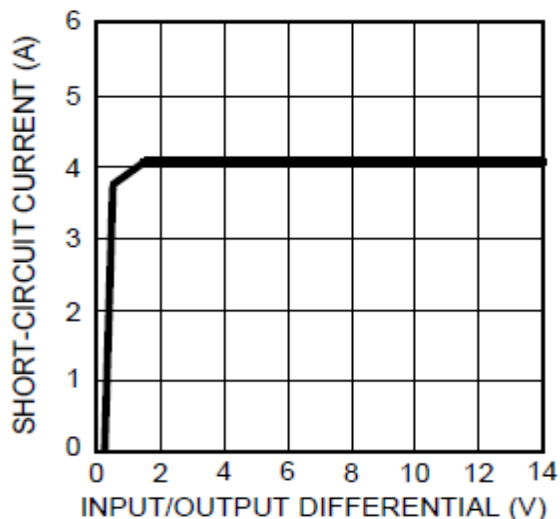

CHARACTERISTIC CURVES

Typical Performance Characteristics (Continue)

Load Transient Response

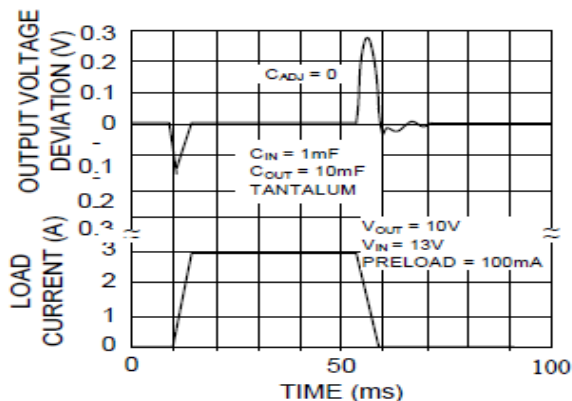

Line Transient Response

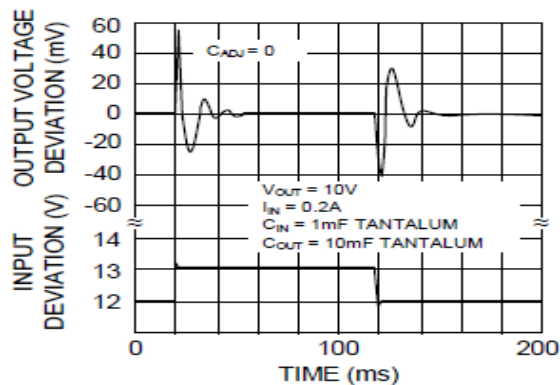

Line Transient Response

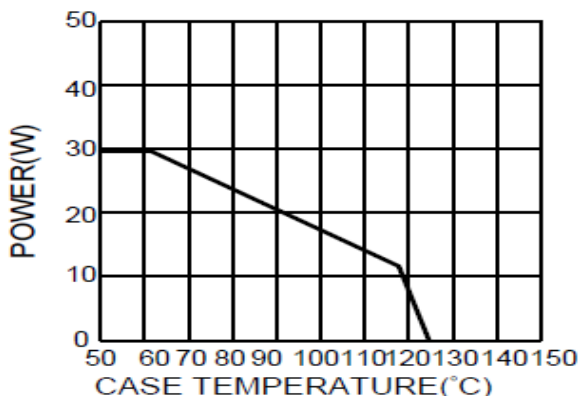

*AS LIMITED BY MAXIMUM JUNCTION TEMPERATURE

Minimum Operating Current

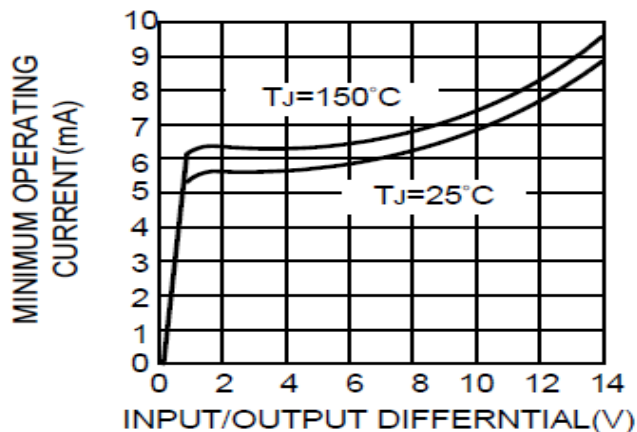

Adjust Pin Current

