

SG2011

300mA , Low Power, Low Dropout, Linear Regulators

GENERAL DESCRIPTION

The SG2011 low-power, low-dropout, CMOS linear voltage regulators operate from a 2.5V to 5.5V input and deliver up to 300mA. They are perfect choice for low voltage, low power applications. An ultra low ground current (110 μ A at 300mA output) makes them attractive for battery operated power systems. The SG2011 series also offer ultra low dropout voltage (210mV at 300mA output) to prolong battery life in portable electronics.

The output voltage is preset to voltages in the range of 1.5V to 5.0V. Other features include foldback current limit and thermal shut-down protection.

SG2011 comes in 3-pin SOT23 and 3-pin SOT89 packages.

FEATURES

- Ultra-Low Dropout Voltage:
210mV at 300mA output
- Low 80 μ A No-Load Supply Current
- Low 110 μ A Operating Supply Current at 300mA Output
- Thermal-Overload Protection
- Output Current Limit
- Preset Output Voltages ($\pm 1.8\%$ Accuracy)
- Output Voltage:
Available in Fixed Outputs of 1.5V, 1.8V, 2.5V, 2.8V, 3.0V, 3.3V, and 3.6V

APPLICATIONS

Cellular Telephones
Digital Cameras
MP3、MP4
USB 2.0
Modems
PC Cameras
Hand-Held Instruments
Electronic Dictionaries
Portable/Battery-Powered Equipment

TYPICAL OPERATION CIRCUIT

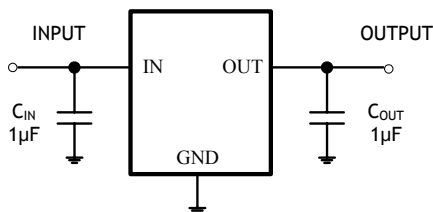

PIN CONFIGURATIONS (TOP VIEW)

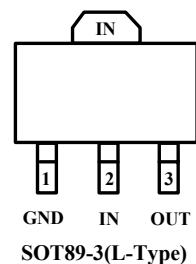
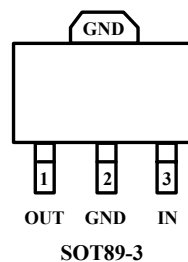
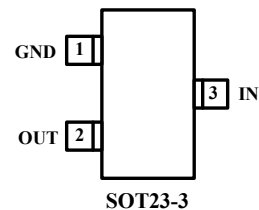

ORDERING INFORMATION

MODEL	V _{OUT} (V)	PIN-PACKAGE	SPECIFIED TEMPERATURE RANGE	ORDERING NUMBER	PACKAGE MARKING	PACKAGE OPTION
SG2011-1.5	1.5V	SOT23-3	- 40°C to +125°C	SG2011-1.5XN3/TR	XB15	Tape and Reel, 3000
		SOT89-3		SG2011-1.5XK3/TR	SG2011-1.5XK3	Tape and Reel, 1000
		SOT89-3(L-Type)		SG2011-1.5XK3L/TR	SG2011-1.5XK3L	Tape and Reel, 1000
SG2011-1.8	1.8V	SOT23-3	- 40°C to +125°C	SG2011-1.8XN3/TR	XB18	Tape and Reel, 3000
		SOT89-3		SG2011-1.8XK3/TR	SG2011-1.8XK3	Tape and Reel, 1000
		SOT89-3(L-Type)		SG2011-1.8XK3L/TR	SG2011-1.8XK3L	Tape and Reel, 1000
SG2011-2.5	2.5V	SOT23-3	- 40°C to +125°C	SG2011-2.5XN3/TR	XB25	Tape and Reel, 3000
		SOT89-3		SG2011-2.5XK3/TR	SG2011-2.5XK3	Tape and Reel, 1000
		SOT89-3(L-Type)		SG2011-2.5XK3L/TR	SG2011-2.5XK3L	Tape and Reel, 1000
SG2011-2.8	2.8V	SOT23-3	- 40°C to +125°C	SG2011-2.8XN3/TR	XB28	Tape and Reel, 3000
		SOT89-3		SG2011-2.8XK3/TR	SG2011-2.8XK3	Tape and Reel, 1000
		SOT89-3(L-Type)		SG2011-2.8XK3L/TR	SG2011-2.8XK3L	Tape and Reel, 1000
SG2011-3.0	3.0V	SOT23-3	- 40°C to +125°C	SG2011-3.0XN3/TR	XB30	Tape and Reel, 3000
		SOT89-3		SG2011-3.0XK3/TR	SG2011-3.0XK3	Tape and Reel, 1000
		SOT89-3(L-Type)		SG2011-3.0XK3L/TR	SG2011-3.0XK3L	Tape and Reel, 1000
SG2011-3.3	3.3V	SOT23-3	- 40°C to +125°C	SG2011-3.3XN3/TR	XB33	Tape and Reel, 3000
		SOT89-3		SG2011-3.3XK3/TR	SG2011-3.3XK3	Tape and Reel, 1000
		SOT89-3(L-Type)		SG2011-3.3XK3L/TR	SG2011-3.3XK3L	Tape and Reel, 1000
SG2011-3.6	3.6V	SOT23-3	- 40°C to +125°C	SG2011-3.6XN3/TR	XB36	Tape and Reel, 3000
		SOT89-3		SG2011-3.6XK3/TR	SG2011-3.6XK3	Tape and Reel, 1000
		SOT89-3(L-Type)		SG2011-3.6XK3L/TR	SG2011-3.6XK3L	Tape and Reel, 1000

ABSOLUTE MAXIMUM RATINGS

IN to GND..... - 0.3V to +6V
 Output Short-Circuit Duration..... Infinite
 OUT to GND..... - 0.3V to (V_{IN} + 0.3V)
 Power Dissipation, P_D @ T_A = 25°C
 SOT23-30.4W
 SOT89-30.571W
 Package Thermal Resistance
 SOT23-3, θ_{JA}..... 250°C/W

SOT89-3, θ_{JA}.....175°C/W
 Operating Temperature Range..... - 40°C to +125°C
 Junction Temperature.....+150°C
 Storage Temperature..... - 65°C to +150°C
 Lead Temperature (soldering, 10s).....260°C
 ESD Susceptibility
 HBM.....7000V
 MM.....400V

Stresses beyond those listed under “Absolute Maximum Ratings” may cause permanent damage to the device. These are stress ratings only, and functional operation of the device at these or any other conditions beyond those indicated in the operational sections of the specifications is not implied. Exposure to absolute maximum rating conditions for extended periods may affect device reliability.

PIN DESCRIPTION

NAME	FUNCTION
IN	Regulator Input. Supply voltage can range from 2.5V to 5.5V.
GND	Ground.
OUT	Regulator Output.

ELECTRICAL CHARACTERISTICS

($V_{IN} = V_{OUT(NOMINAL)} + 0.5V$ or $2.5V$ (whichever is greater), $T_A = -40^{\circ}C$ to $+125^{\circ}C$, unless otherwise noted. Typical values are at $T_A = +25^{\circ}C$.)

PARAMETER	SYMBOL	CONDITIONS	MIN	TYP	MAX	UNITS
Input Voltage	V_{IN}		2.5		5.5	V
Output Voltage Accuracy		$I_{OUT} = 0.1mA$, $T_A = +25^{\circ}C$	-1.8		1.8	%
		$I_{OUT} = 0.1mA$ to $300mA$, $T_A = 0^{\circ}C$ to $+70^{\circ}C$			2.5	
		$I_{OUT} = 0.1mA$ to $300mA$, $T_A = -40^{\circ}C$ to $+125^{\circ}C$			2.9	
Output Current			300			mA
Current Limit	I_{LIM}		310	750		mA
Ground Pin Current	I_Q	No load		80	140	μA
		$I_{OUT} = 300mA$		110		
Dropout Voltage(Note1)		$I_{OUT} = 1mA$		0.8		mV
		$I_{OUT} = 300mA$		210	340	
Line Regulation	ΔV_{LNR}	$V_{IN} = 2.5V$ or $(V_{OUT} + 0.1V)$ to $5.5V$, $I_{OUT} = 1mA$		0.004	0.15	%/V
Load Regulation	ΔV_{LDR}	$I_{OUT} = 0.1mA$ to $300mA$, $C_{OUT} = 1\mu F$		0.0005	0.002	%/mA
Output Voltage Noise	e_n	$f = 10Hz$ to $100KHz$, $C_{OUT} = 10\mu F$		120		$\mu VRMS$
Power Supply Rejection Rate	PSRR	$I_{LOAD} = 50mA$, $C_{OUT} = 1\mu F$	$f = 100Hz$,		74	dB
			$f = 1KHz$,		54	dB
THERMAL PROTECTION						
Thermal Shutdown Temperature	T_{SHDN}			160		$^{\circ}C$
Thermal Shutdown Hysteresis	ΔT_{SHDN}			15		$^{\circ}C$

Specifications subject to change without notice.

Note 1: The dropout voltage is defined as $V_{IN} - V_{OUT}$, when V_{OUT} is 100mV below the value of V_{OUT} for $V_{IN} = V_{OUT} + 0.5V$. (Only applicable for $V_{OUT} = +2.5V$ to $+5.0V$)

TYPICAL OPERATING CHARACTERISTICS

$V_{IN} = V_{OUT(NOMINAL)} + 0.5V$ or $2.5V$ (whichever is greater), $C_{IN} = 1\mu F$, $C_{OUT} = 1\mu F$, $T_A = +25^\circ C$, unless otherwise noted.

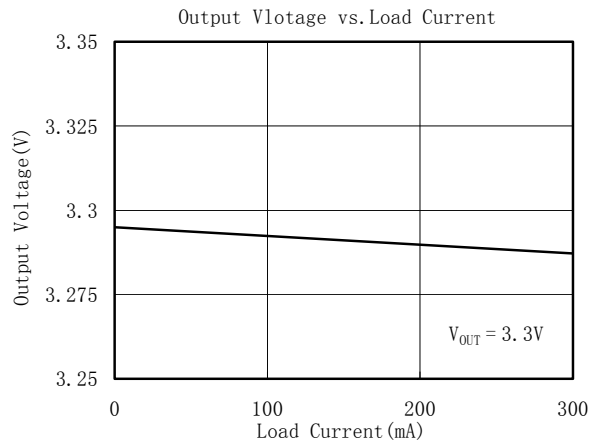
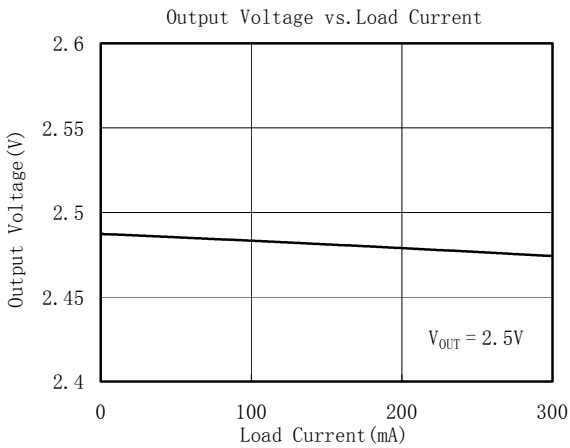
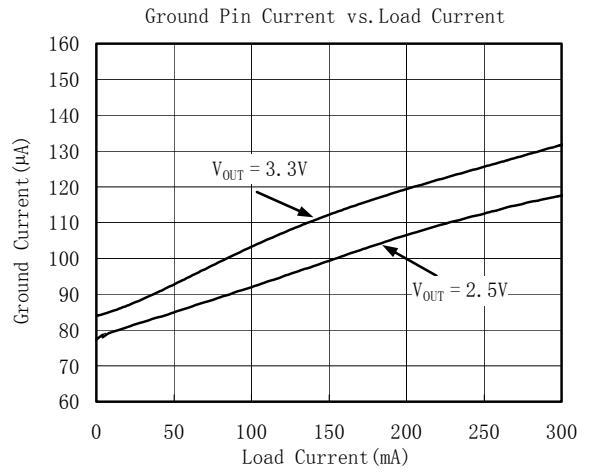
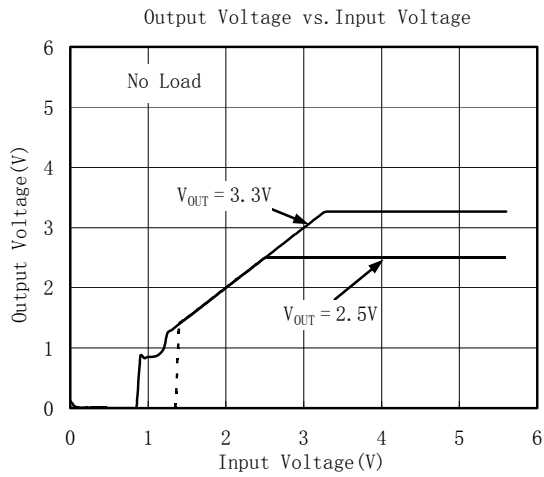
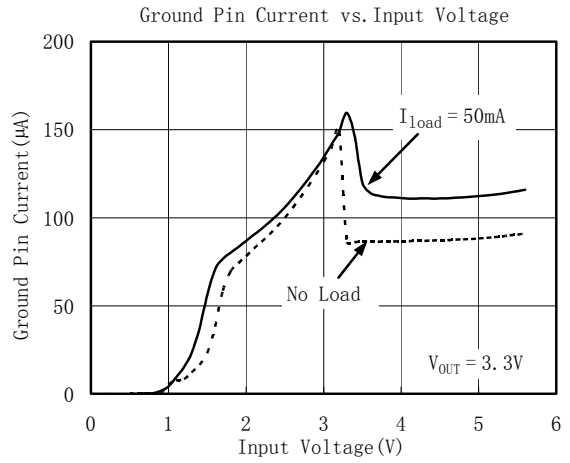
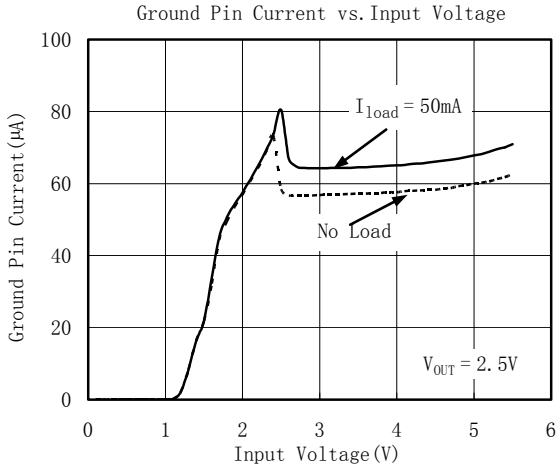

TYPICAL OPERATING CHARACTERISTICS

$V_{IN} = V_{OUT(NOMINAL)} + 0.5V$ or $2.5V$ (whichever is greater), $C_{IN} = 1\mu F$, $C_{OUT} = 1\mu F$, $T_A = +25^\circ C$, unless otherwise noted.

Line-Transient Response

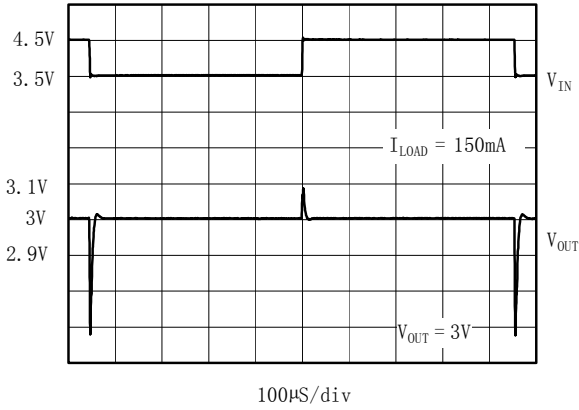

Load-Transient Response

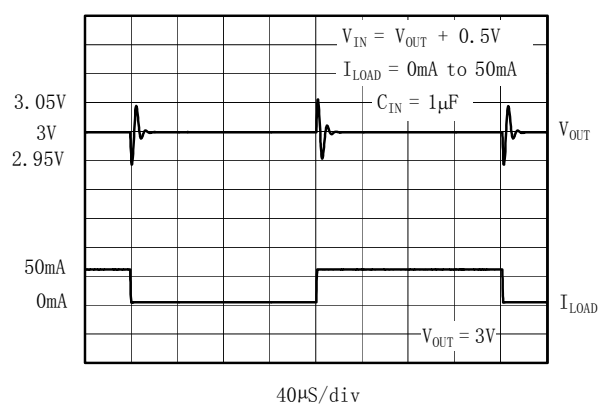

Load-Transient Response Near Dropout

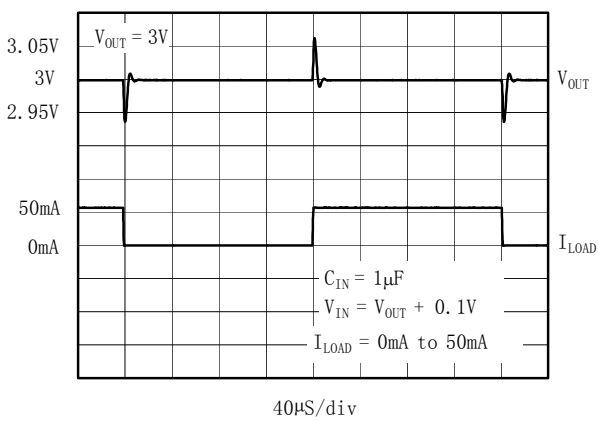

Power-Supply Rejection Ratio vs. Frequency

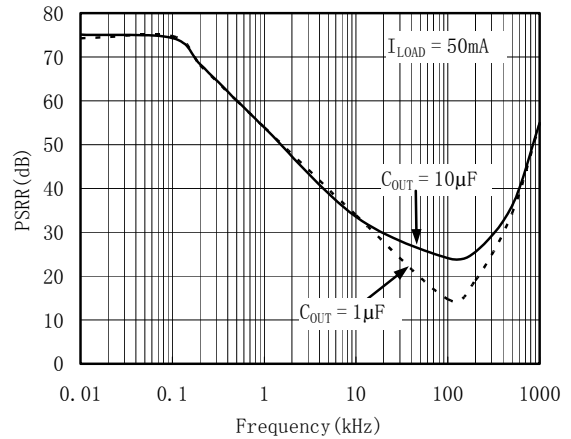

Region of Stable C_OUT ESR vs. Load Current

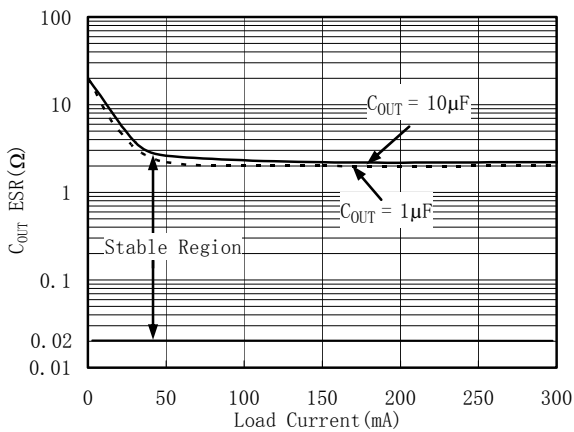

Current limit vs. Temperature

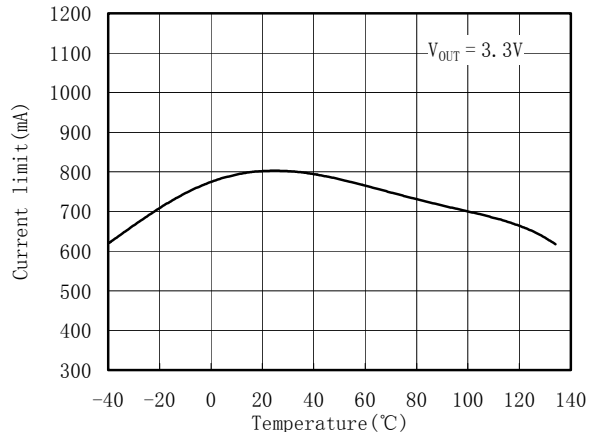

TYPICAL OPERATING CHARACTERISTICS

$V_{IN} = V_{OUT(NOMINAL)} + 0.5V$ or $2.5V$ (whichever is greater), $C_{IN} = 1\mu F$, $C_{OUT} = 1\mu F$, $T_A = +25^\circ C$, unless otherwise noted.

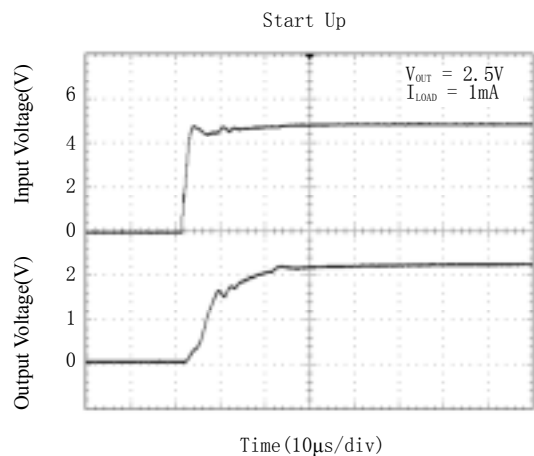
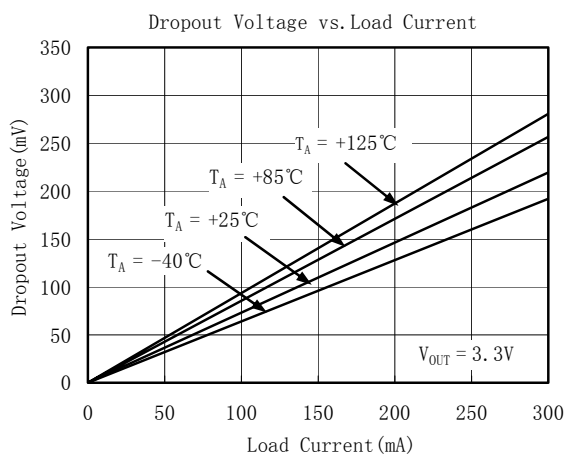
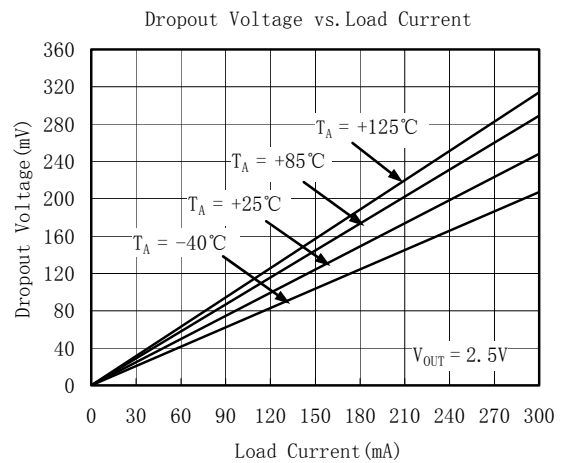
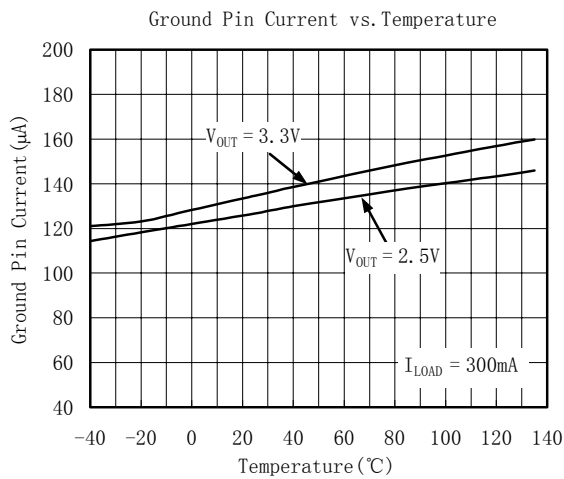
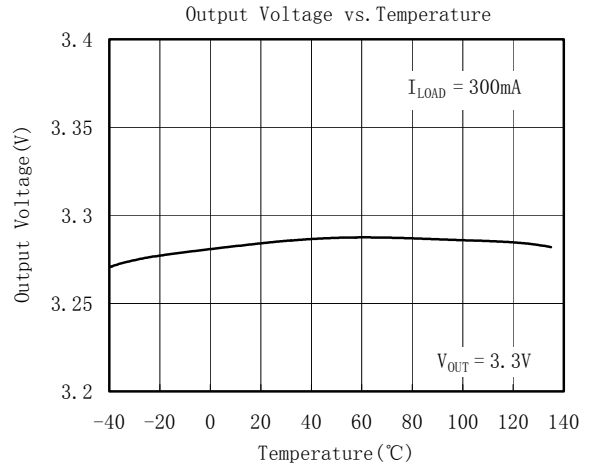
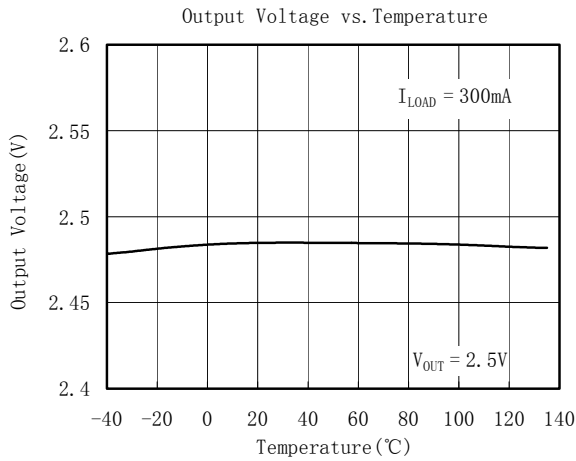

Application Notes

When LDO is used in handheld products, Attention must be paid to voltage spike which would damage SG2011. In such applications, voltage spike will be generated at charger interface and V_{BUS} pin of USB interface when charger adapters and USB equipments are hot-inserted. Besides this, handheld products will be tested on the production line on the condition of no battery. Test Engineer will apply power from the connector pin which connects with positive pole of the battery. When external power supply is turned on suddenly, the voltage spike will be generated at the battery connector. The voltage spike will be very high, it always exceeds the absolute maximum input voltage (6.0V) of LDO. In order to get robust design. Design Engineer needs to clear up this voltage spike. Zener diode is a cheap and effective solution to eliminate such voltage spike. For example, BZM55B5V6 is a 5.6V small package Zener diode which can be used to remove voltage spike in cell phone design. The schematic is shown in below:

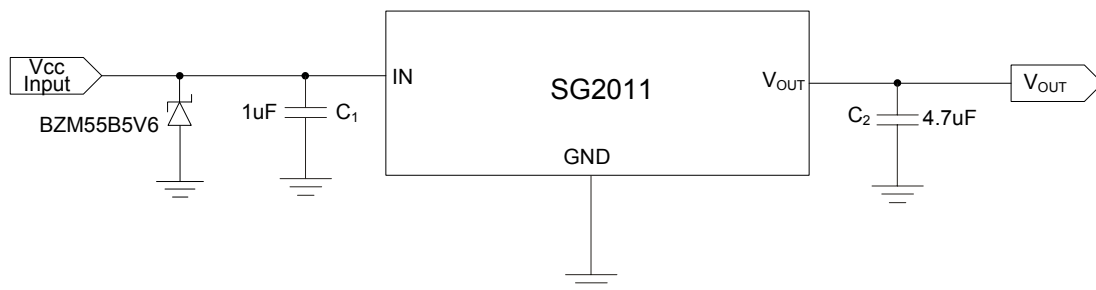

PACKAGE OUTLINE DIMENSIONS

SOT23-3

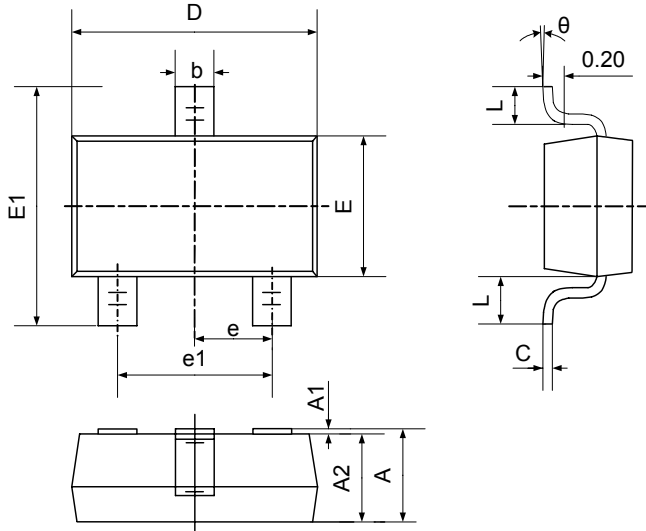

Symbol	Dimensions In Millimeters		Dimensions In Inches	
	Min	Max	Min	Max
A	1.050	1.250	0.041	0.049
A1	0.000	0.100	0.000	0.004
A2	1.050	1.150	0.041	0.045
b	0.300	0.400	0.012	0.016
c	0.100	0.200	0.004	0.008
D	2.820	3.020	0.111	0.119
E	1.500	1.700	0.059	0.067
E1	2.650	2.950	0.104	0.116
e	0.950TYP		0.037TYP	
e1	1.800	2.000	0.071	0.079
L	0.700REF		0.028REF	
L1	0.300	0.600	0.012	0.024
θ	0°	8°	0°	8°

PACKAGE OUTLINE DIMENSIONS

SOT89-3

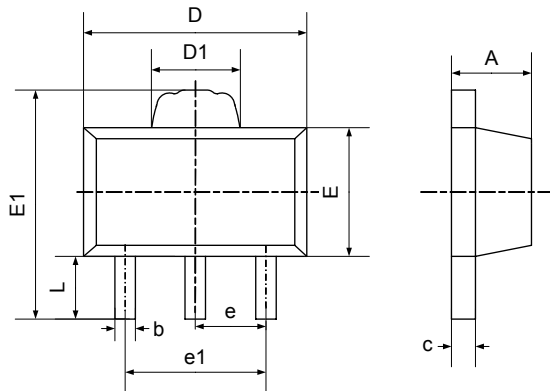

Symbol	Dimensions In Millimeters		Dimensions In Inches	
	Min	Max	Min	Max
A	1.400	1.600	0.055	0.063
b	0.320	0.520	0.013	0.020
b1	0.360	0.560	0.014	0.022
c	0.350	0.440	0.014	0.017
D	4.400	4.600	0.173	0.181
D1	1.400	1.800	0.055	0.071
E	2.300	2.600	0.091	0.102
E1	3.940	4.250	0.155	0.167
e	1.500TYP		0.060TYP	
e1	2.900	3.100	0.114	0.122
L	0.900	1.100	0.035	0.043

REVISION HISTORY

Location	Page
9/05— Data Sheet changed from preliminary to REV. A	
12/06— Data Sheet changed from REV. A to REV. B	
Changed to ABSOLUTE MAXIMUM RATINGS	2
Added Application Notes	7

Shengbang Microelectronics Co, Ltd

Unit 3, ChuangYe Plaza
No.5, TaiHu Northern Street, YingBin Road Centralized Industrial Park
Harbin Development Zone
Harbin, HeiLongJiang 150078
P.R. China
Tel.: 86-451-84348461
Fax: 86-451-84308461
www.sg-micro.com