

Schottky Barrier Diodes (Surface Mount) 60V, 90V

Parameter Type No.	Absolute Maximum Ratings					Electrical Characteristics (Ta=25°C)					Others			
	VRM (V)	IF(AV) (A)	IFSM (A) 50Hz Half-cycle Sinewave Single Shot	Tj (°C)	Tstg (°C)	VF (V)		IR (mA)	IR (H) (mA)	trr (ns)	Rth(j-ℓ) (°C/W)	Mass (g)	Fig.	
						max	IF (A)	VR=VRM max	VR=VRM Ta=100°C max					
SFPB-56	60	0.7	10	-40 to +150		0.62	0.7	1.00	7.5	100	100/100	20.0	0.072	Ⓐ
SFPB-66		2.0	25			0.69	2.0	1.0	15					
SFPB-76		2.0	40			0.62	2.0	2.00	20					
SFPB-59	90	0.7	10			0.81	0.7	1.00	5					
SFPB-69 *		1.5	40			1.5	2.0	10						

* Under development

SFPB-56

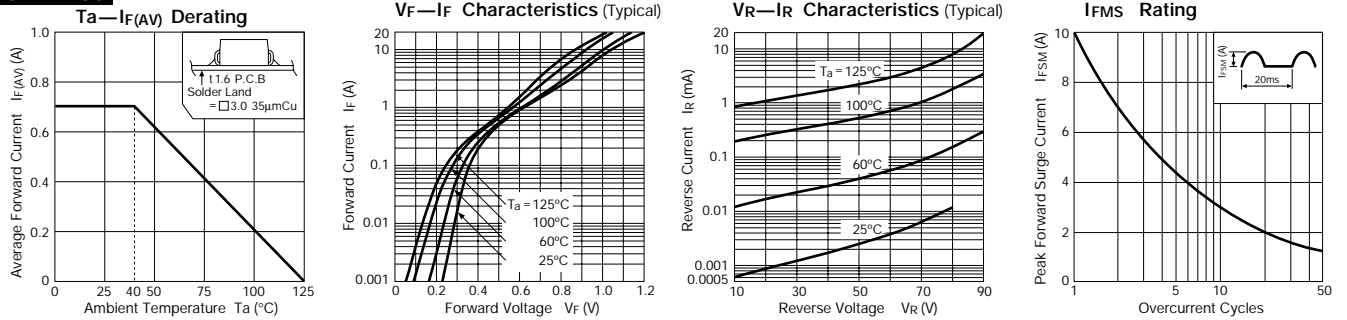

SFPB-66

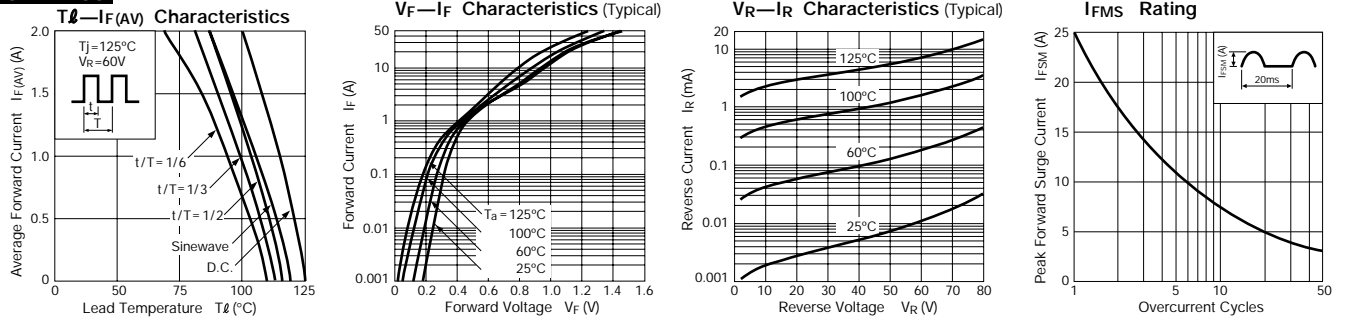

SFPB-76

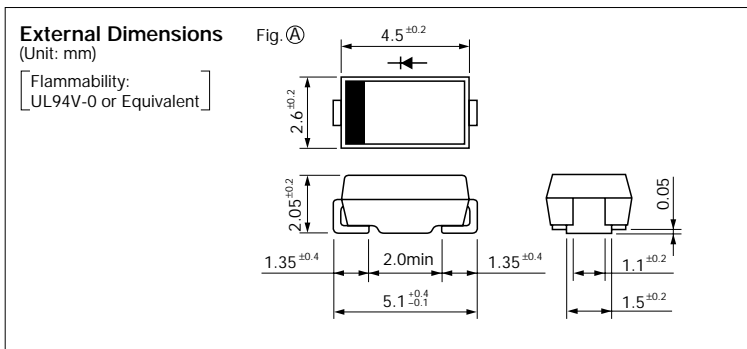
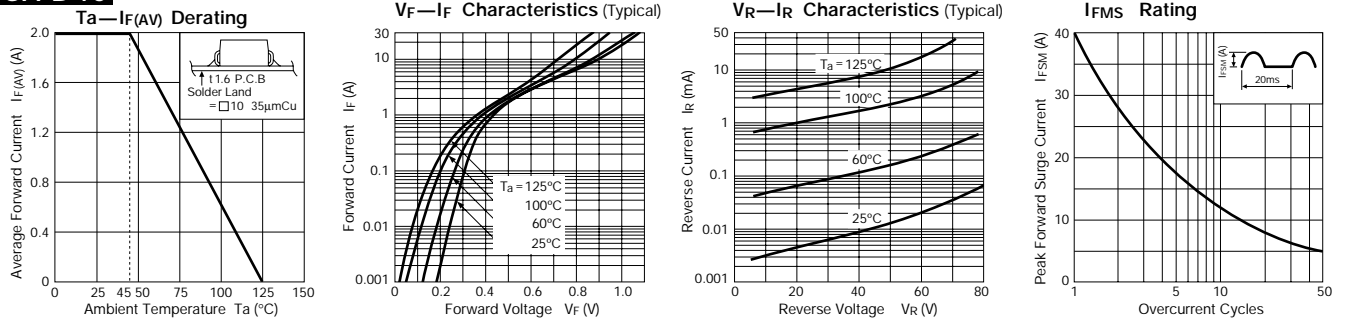

SFPB-59

Ta—If(AV) Derating

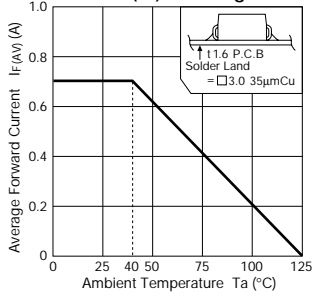

V_F—I_F Characteristics (Typical)

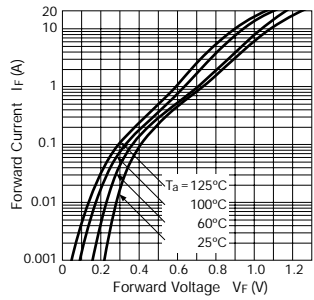

V_R—I_R Characteristics (Typical)

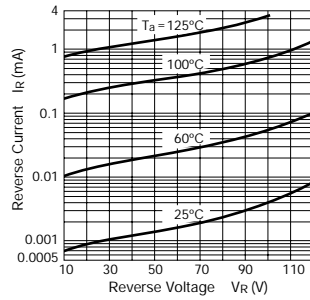

I_{FMS} Rating

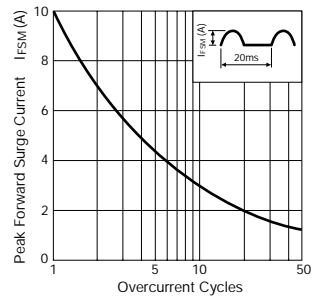

SFPB-69

T_l—I_{F(AV)} Characteristics

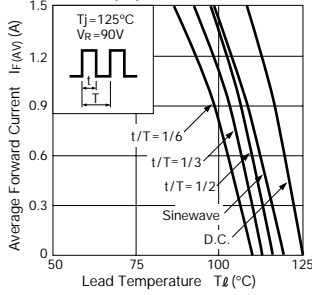

V_F—I_F Characteristics (Typical)

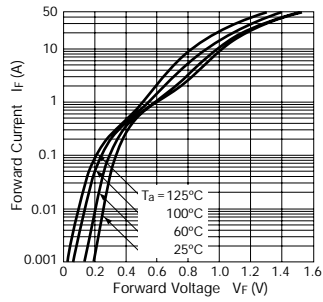

V_R—I_R Characteristics (Typical)

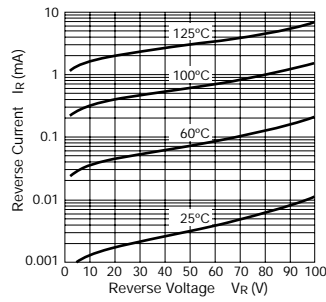

I_{FMS} Rating

