

**5.0 Amp Glass Passivated Super Fast Rectifiers - 50~600Volts**

**DO-201AD Package**

**Features**

- Glass Passivated Chip
- Low Forward Voltage
- High Current Capability
- High reliability
- Super Fast Switching Speed
- High Surge Current Capability
- Moisture Sensitivity Level 1
- RoHS product for packing code suffix "G"
- Halogen free product for packing code suffix "H"

**Mechanical Date**

- Case: Molded Plastic, DO-201AD
- Epoxy: UL 94V-0 Rate Flame Retardant
- Lead: Solderable per MIL-STD-202, method 208 guaranteed
- Polarity: Color band denotes cathode end
- Mounting Position: Any
- Weight: 0.046 ounce, 1.18 gram (Approximate)



**DO-201AD**

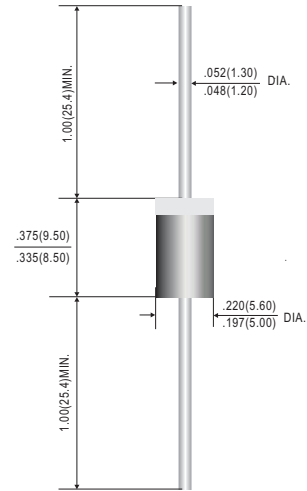

Dimensions in inches and (millimeters)

**MAXIMUM RATINGS AND ELECTRICAL CHARACTERISTICS**

Ratings at 25°C ambient temperature unless otherwise specified.

Single phase half wave, 60Hz, resistive or inductive load.

For capacitive load, derate current by 20%

RATINGS		SYMBOLS	SF51G	SF52G	SF53G	SF54G	SF55G	SF56G	SF58G	UNITS
Maximum Recurrent Peak Reverse Voltage		$V_{RRM}$	50	100	150	200	300	400	600	Volts
Maximum RMS Voltage		$V_{RMS}$	35	70	105	140	210	280	420	Volts
Maximum DC Blocking Voltage		$V_{DC}$	50	100	150	200	300	400	600	Volts
Maximum Average Forward rectifier Current 0.375" (9.5mm) Lead length at Ta = 55°C		$I_{F(AV)}$	5.0							Amps
Peak Forward Surge Current 8.3 ms single half sine-wave superimposed on rated load (JEDEC method)		$I_{FSM}$	150							Amps
Maximum Instantaneous Forward Voltage at 5.0A DC		$V_F$	0.95				1.27		1.75	Volts
Maximum DC Reverse Current at Rated DC Blocking Voltage	@ Ta=25°C	$I_R$	5.0							µA
	@ Ta=100°C		100							
Maximum Reverse Recovery Time (Note 1)		$T_{RR}$	35							ns
Typical Thermal Resistance (Note 3)		$R_{\theta JA}$	50							°C/W
		$R_{\theta JL}$	20							
Typical Junction Capacitance(Note 2)		$C_J$	50				30			pF
Operating and Storage Temperature Range		$T_J, T_{STG}$	-55 ~ 150							°C

**Notes:**

1. Test Conditions:  $I_F = 0.5A$ ,  $I_R = -1.0A$ ,  $I_{RR} = -0.25A$
2. Measured at 1MHz and applied reverse voltage of 4.0VDC.
3. Typical Thermal Resistance: At 9.5mm lead lengths, PCB mounted.

**RATING AND CHARACTERISTICS CURVES**

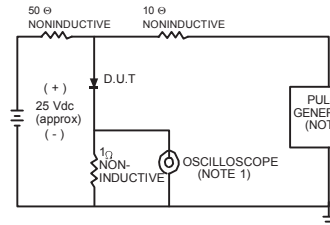

NOTES: 1. Rise Time = 7ns max. Input Impedance = 1 megohm. 22pF.  
2. Rise Time = 10ns max. Source Impedance = 50 ohms.

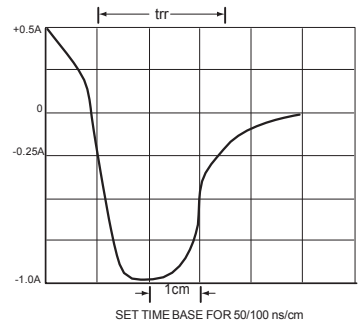

FIG.1 TEST CIRCUIT DIAGRAM AND REVERSE RECOVERY TIME CHARACTERISTIC

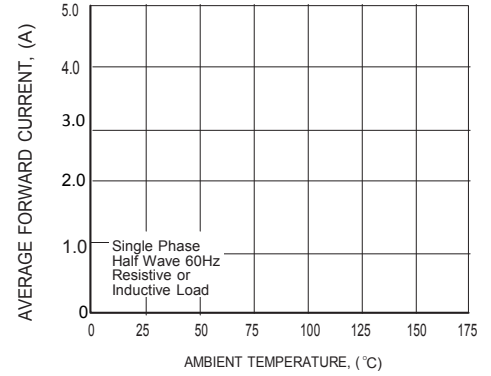

FIG.2 TYPICAL FORWARD CURRENT DERATING CURVE

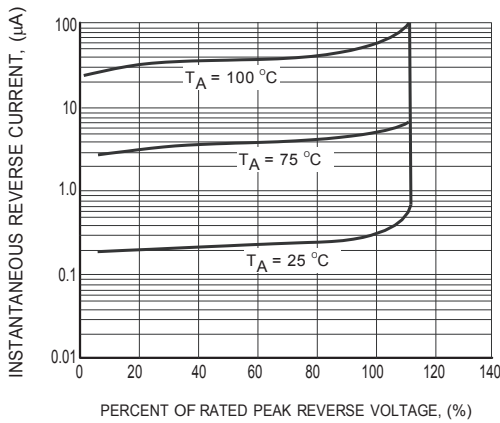

FIG.3 TYPICAL REVERSE CHARACTERISTICS

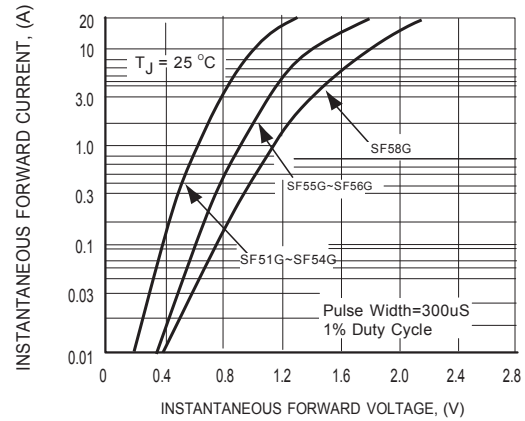

FIG.4 TYPICAL INSTANTANEOUS FORWARD CHARACTERISTICS

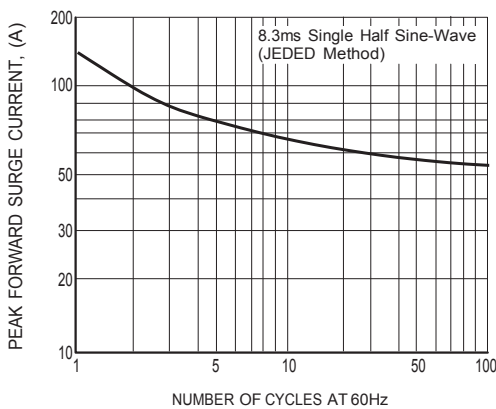

FIG.5 MAXIMUM NON-REPETITIVE FORWARD SURGE CURRENT

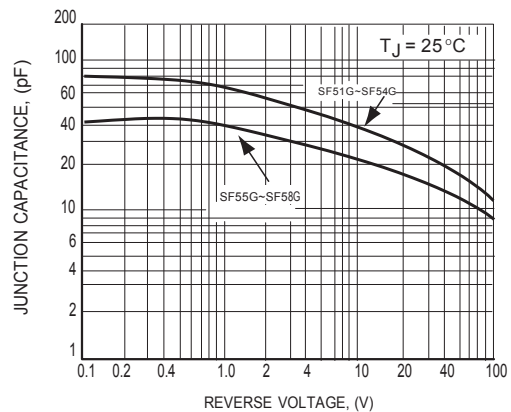

FIG.6 TYPICAL JUNCTION CAPACITANCE