

NAIS

POLARISED, MONOSTABLE SAFETY RELAY with (mechanical linked) forced contacts operation

SF-RELAYS

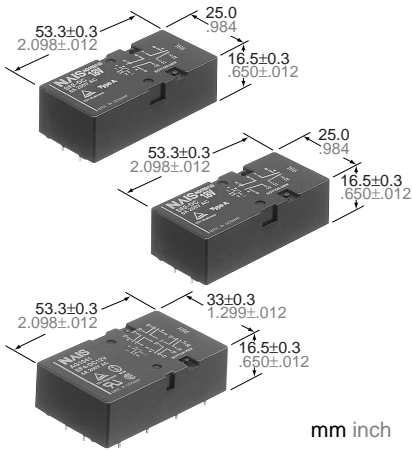

FEATURES

- Forced operation contacts (2 Form A 2 Form B, 3 Form A 1 Form B)**
 N.O. and N.C. side contacts are connected through a card so that one interacts with the other in movement. In case of a contact welding, the other keeps a min. 0.5mm .020inch contact gap.
- Independent operation contacts (4 Form A 4 Form B)**
 Each pair of contacts is free from the main armature and is independent from each other. So if a N.O. pair of contacts are welded, the other 3 N.O. contacts are not effected (operate properly) That

enables to plan a circuit to detect welding or go back to the beginning condition.

- Separated chamber structure (2 Form A 2 Form B, 3 Form A 1 Form B, 4 Form A 4 Form B)**
 N.O. and N.C. side contacts are put in each own space surrounded with a card and a body-separater. That prevents short circuit between contacts, which is caused by their springs welding or damaged.
- UL/CSA, TÜV, SEV approved**
 (UL/CSA, SEV of SF3 pending)

SPECIFICATIONS

Contact		SF2	SF3	SF4
Type		SF2	SF3	SF4
Arrangement		2 Form A 2 Form B	3 Form A 1 Form B	4 Form A 4 Form B
Initial contact resistance, max. (By voltage drop 6 V DC 1 A)		30 mΩ		
Contact material		Gold-flashed silver alloy		
Rating (resistive)	Nominal switching capacity	6 A 250 V AC, 6 A 30 V DC		
	Max. switching power	1,500 VA, 180 W		
	Max. switching voltage	30 V DC, 440 V AC		
	Max. carrying current	6 A DC, AC		
Expected life (min. operations)	Mechanical (at 180 cpm) (resistive)	10 ⁷		
	Electrical (at 20 cpm)	3×10 ⁴ *1		10 ⁵

Coil (at 25°C 77°F)	
Nominal operating power	500 mW

Remarks

* Specifications will vary with foreign standards certification ratings.

*1 More than 10⁵ operations when applying the nominal switching capacity to one side of contact pairs of each Form A contact and Form B contact

*2 Measurement at same location as " Initial breakdown voltage " section

*3 Detection current: 10mA

*4 Excluding contact bounce time

*5 Half-wave pulse of sine wave: 11ms; detection time: 10μs

*6 Half-wave pulse of sine wave: 6ms

*7 Detection time: 10μs

*8 Refer to 5. Conditions for operation, transport and storage mentioned in AMBIENT ENVIRONMENT (Page 61).

Characteristics (at 25°C 77°F, 50% Relative humidity)		SF2	SF3	SF4
Max. operating speed		180 cpm (at nominal voltage)		
Initial insulation resistance*2		Min. 1,000 MΩ at 500 V DC		
Initial break-down voltage*3	Between contact sets	2,500 Vrms		
	Between open contacts	2,500 Vrms		
	Between contact and coil	2,500 Vrms		
Operate time*4 (at nominal voltage)		Approx. 17 ms	Approx. 18 ms	
Release time (without diode)*4 (at nominal voltage)		Approx. 7 ms	Approx. 6 ms	
Temperature rise (at nominal voltage)		Max. 45°C with nominal coil voltage and at 6 A switching current		
Shock resistance	Functional*5	Min. 294 m/s ² {30 G}		
	Destructive*5	Min. 980 m/s ² {100 G}		
Vibration resistance	Functional*7	117.6 m/s ² {12 G}, 10 to 55 Hz at double amplitude of 2 mm		
	Destructive	117.6 m/s ² {12 G}, 10 to 55 Hz at double amplitude of 2 mm		
Conditions for operation, transport and storage*8 (Not freezing and condensing at low temperature)	Ambient temp.	-40°C to +70°C -40°F to +158°F		
	Humidity	5 to 85% R.H.		
Unit weight		37 g 1.31 oz	47 g 1.66 oz	

ORDERING INFORMATION

Ex. SF 2 ——— DC 12 V

Contact arrangement	Coil voltage
2: 2 Form A 2 Form B	DC 5, 9, 12, 18, 21,
3: 3 Form A 1 Form B	24, 36, 48, 60 V
4: 4 Form A 4 Form B	

UL/CSA, TÜV, SEV approved type is standard (SF2, SF4)
 TÜV approved type is standard (SF3)

TYPICAL APPLICATIONS

- Signal
- Escalator
- Elevator
- Medical Instruments
- Railway
- Factory Automation

TYPES AND COIL DATA (at 20°C 68°F)

Contact arrangement	Part No.	Nominal voltage, V DC	Pick-up voltage, VDC (max.)	Drop-out voltage, V DC (min.)	Coil resistance Ω ($\pm 10\%$)	Nominal operating current, mA ($\pm 10\%$)	Nominal operating power, mW	Max. allowable voltage, V DC
SF2	SF2-DC5V	5	3.75	0.5	50	100	500	6
	SF2-DC9V	9	6.75	0.9			500	10.8
	SF2-DC12V	12	9	1.2	288	41.7	500	14.4
	SF2-DC18V	18	13.5	1.8			500	21.6
	SF2-DC21V	21	15.75	2.1			500	25.2
	SF2-DC24V	24	14.4	2.4	1.152	20.8	500	28.8
	SF2-DC36V	36	27	3.6			500	43.2
	SF2-DC48V	48	36	4.8	4.608	10.4	500	57.6
SF3	SF3-DC5V	5	3.75	0.5	50	100	500	6
	SF3-DC9V	9	6.75	0.9			500	10.8
	SF3-DC12V	12	9	1.2	288	41.7	500	14.4
	SF3-DC18V	18	13.5	1.8			500	21.6
	SF3-DC21V	21	15.75	2.1			500	25.2
	SF3-DC24V	24	14.4	2.4	1.152	20.8	500	28.8
	SF3-DC36V	36	27	3.6			500	43.2
	SF3-DC48V	48	36	4.8	4.608	10.4	500	57.6
SF4	SF4-DC5V	5	3.75	0.75	50	100	500	6
	SF4-DC9V	9	6.75	0.9			500	10.8
	SF4-DC12V	12	9	1.8	288	41.7	500	14.4
	SF4-DC18V	18	13.5	1.8			500	21.6
	SF4-DC21V	21	15.75	2.1			500	25.2
	SF4-DC24V	24	14.4	3.6	1.152	20.8	500	28.8
	SF4-DC36V	36	27	3.6			500	43.2
	SF4-DC48V	48	36	7.2	4.608	10.4	500	57.6
SF4-DC60V	60	45	9.0	7.200	8.3	500	72	

DIMENSIONS

1) SF2

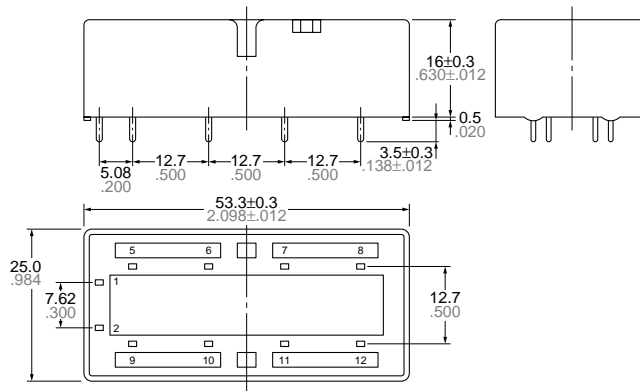
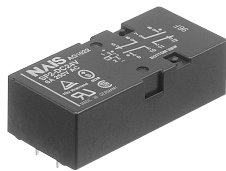

General tolerance: $\pm 0.3 \pm 0.012$

mm inch

Schematic (Bottom view)

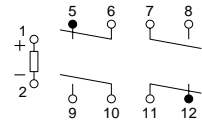

PC board pattern (Bottom view)

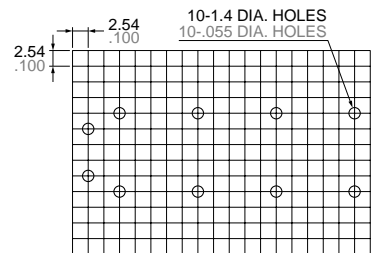

Tolerance: $\pm 0.1 \pm .004$

2) SF3

mm inch

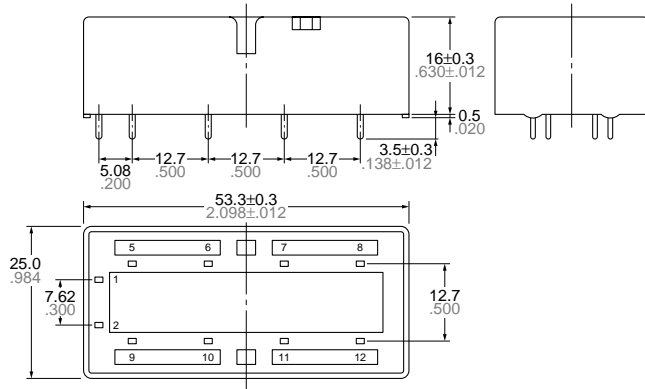

General tolerance: ±0.3 ±.012

Schematic (Bottom view)

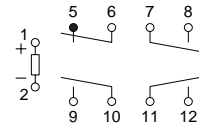

PC board pattern (Bottom view)

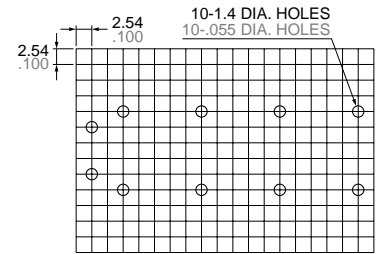

Tolerance: ±0.1 ±.004

3) SF4

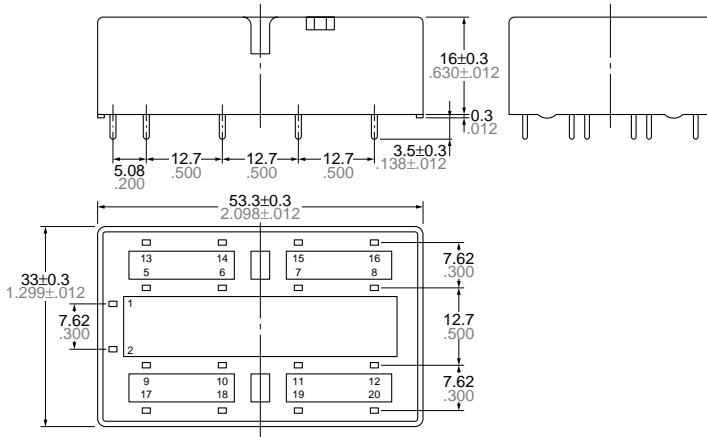
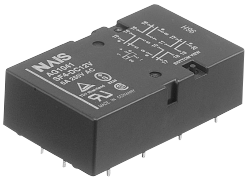

General tolerance: ±0.3 ±.012

Schematic (Bottom view)

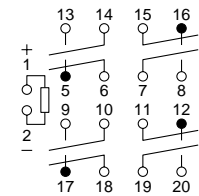

PC board pattern (Bottom view)

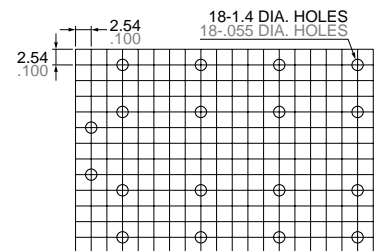

Tolerance: ±0.1 ±.004

REFERENCE DATA

1. Operate/release time

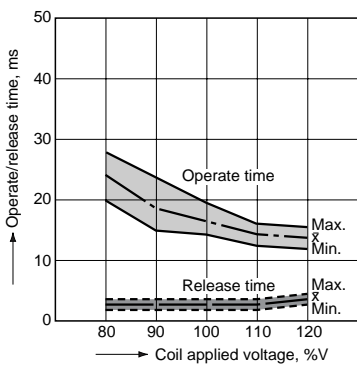

2. Coil temperature rise

Coil applied voltage: 120%V
Contact switching current: 6A

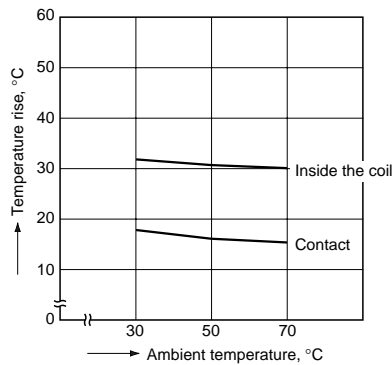

3. Ambient temperature characteristics

Tested sample: SF4-DC12V
Quantity: n = 6

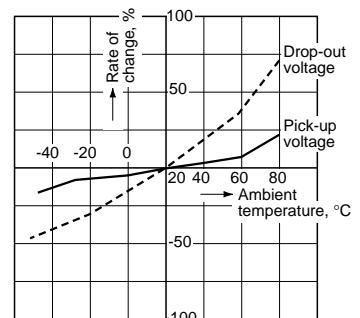

SAFETY STRUCTURE OF SF RELAYS

This SF relay design ensures that subsequent operations shut down and can automatically return to a safe state when the SF relay suffers overloading and other circuit abnormalities (unforeseen

externally caused circuit or device breakdowns, end of life incidents, and noise, surge, and environmental influences) owing to contact welding, spring fusion or, in the worst-case

scenario, relay breakdown (coil rupture, faulty operation, faulty return, and fatigue and breakage of the operating spring and return spring), and even in the event of end of life.

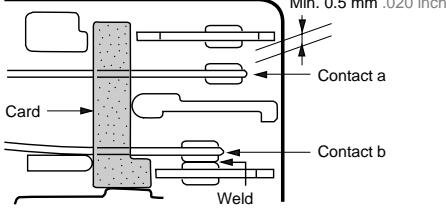
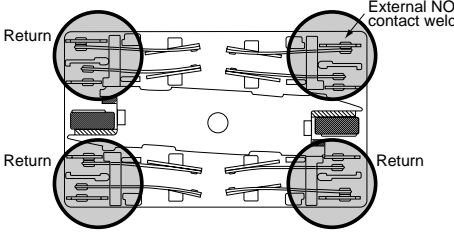
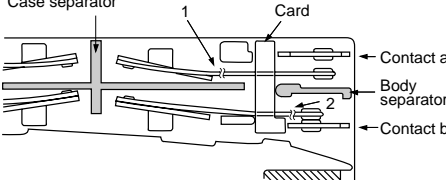
	Structure	Operation
<p>1. Forced operation method (2a2b, 3a1b, 4a4b types)</p>	 <p>The two contacts "a" and "b" are coupled with the same card. The operation of each contact is regulated by the movement of the other contact.</p>	<p>Even when one contact is welded closed, the other maintains a gap of greater than 0.5 mm .020 inch.</p> <p>In the diagram on the left, the lower contact "b" have welded but the upper contact "a" maintain at a gap of greater than 0.5 mm .020 inch. Subsequent contact movement is suspended and the weld can be detected</p>
<p>2. Independent operation method (4a4b type)</p>	 <p>None of four contacts are held in position by the armature. Even though one of the external N.O. contacts has welded, the other three contacts have returned owing to the de-energizing of the coil.</p>	<p>Enables design of safety circuits that allow weld detection and return at an early stage.</p> <p>As shown at the top right of the diagram on the left, if the external N.O. contact welds, a 0.5 mm .020 inch gap is maintained. Each of the other contacts returns to N.O. because the coil is no longer energized.</p>
<p>3. Separate chamber method (2a2b, 3a1b, 4a4b types)</p>	<p>In independent chambers, the contacts "a" and "b" are kept apart by a body/card separator or by the card itself.</p> 	<p>Prevents shorting and fusing of springs and spring failure owing to short-circuit current.</p> <p>As shown on the diagram on the left, even if the operating springs numbered 1 and 2 there is no shorting between "a" and "b" contacts.</p>
<p>4. High-efficiency 4-gap balanced armature structure (2a2b, 3a1b, 4a4b types)</p>	<p>The use of high-efficiency magnetically polarized circuits and 4-gap balanced armature structure means that springs are not required.</p>	<p>Does away with return faults due to fatigue or breakage of the return spring, especially stoppage during contact states.</p>
<p>5. 2a2b contact 3a1b contact 4a4b contact</p>	<p>Structure with independent COM contact of (2a2b), (3a1b), (4a4b) contacts.</p>	<p>Independent COM enables differing pole circuit configurations. This makes it possible to design various kinds of control circuits and safety circuits.</p>

THE OPERATION OF SF RELAYS (when contacts are welded)

SF relays work to maintain a normal operating state even when overloading or short-circuit currents occur. It is also easy to include weld detection circuits and safety circuits in the design to ensure safety even if contacts weld.

1) 2a2b Type

Form "b" Contact Weld

If the form "b" contacts (Nos. 1 and 3) weld, the armature becomes non-operational and the contact gap of the two form "a" contacts is maintained at greater than 0.5 mm .020 inch. Reliable isolation is thus ensured.

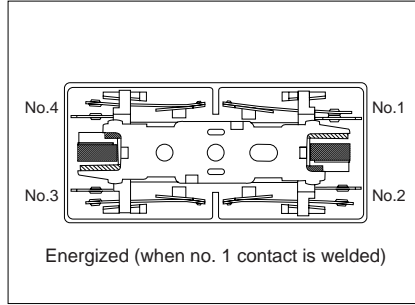
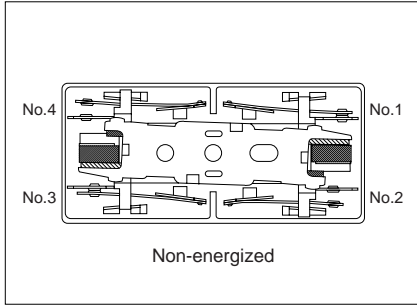

If the No. 1 contact welds. A gap of greater than 0.5 mm .020 inch is maintained at each of the two form "a" contacts (Nos. 2 and 4).

Form "a" Contact Weld

If the two form "a" contacts (Nos. 2 and 4) weld, the armature becomes non-operational and the gap between the two form "b" contacts is maintained at greater than 0.5 mm .020 inch. Reliable isolation is thus ensured.

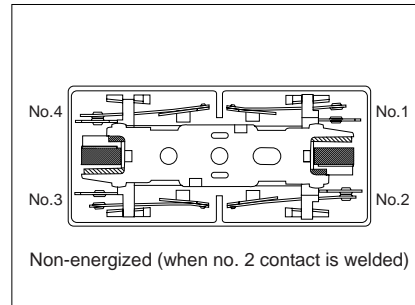
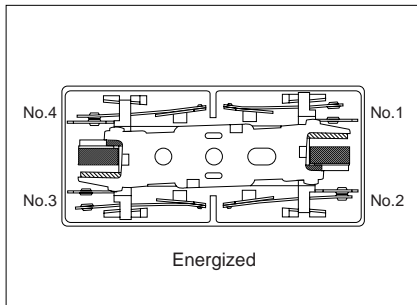

If the No. 2 contact welds. Each of the two form "b" contacts (Nos. 1 and 3) maintains a gap of greater than 0.5 mm .020 inch.

Contact Operation Table

The table below shows the state of the other contacts when the current through the welded form "a" contact is 0 V and the rated voltage is applied through the form "b" contact.

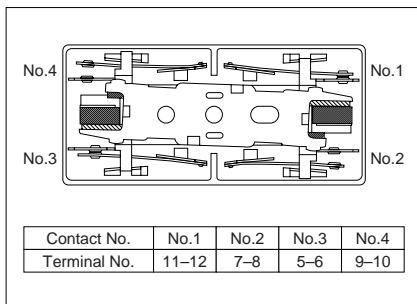

Contact No.		State of other contacts			
		1	2	3	4
Welded terminal No.	1	>0.5			>0.5
	2	>0.5	>0.5		
	3		>0.5	>0.5	
	4	>0.5		>0.5	>0.5

>0.5: contact gap is kept at min. 0.5 mm .020 inch
Empty cells: either closed or open

Note: Contact gaps are shown at the initial state. If the contacts change state owing to loading/breaking it is necessary to check the actual loading.

2) 3a1b Type

Form "b" Contact Weld

If the form "b" contact (No. 3) welds, the armature becomes non-operational, the contact gaps at the three form "a" contacts are maintained at greater than 0.5 mm .020 inch. Reliable isolation is thus ensured

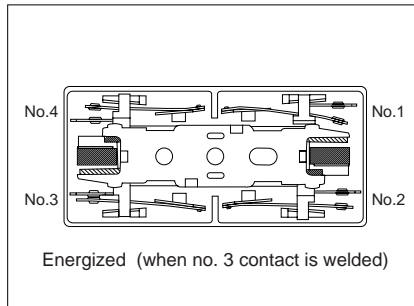
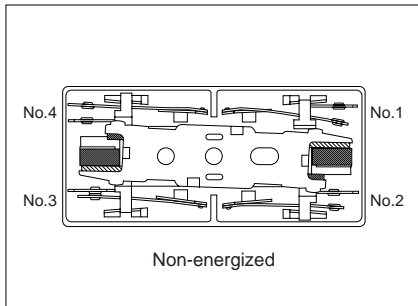

If the No. 3 contact welds. Each of the two form "a" contacts (Nos. 1, 2, and 4) maintain a gap of greater than 0.5 mm .020 inch.

Form "a" Contact Weld

When the form "a" contacts (nos. 1, 2, and 4) weld, the armature remains in a non-returned state and the contact gap at the single form "b" contact is maintained at greater than 0.5 mm .020 inch. Reliable isolation is thus ensured.

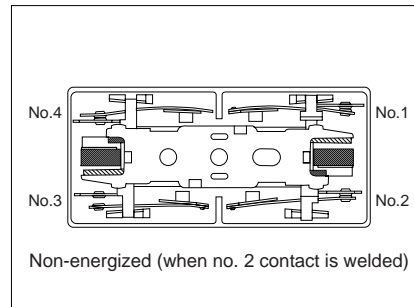
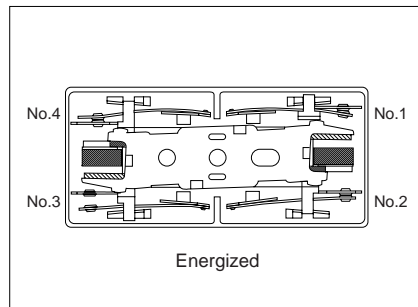

If the No. 2 contact welds. The single form "b" contact (No. 3) maintains a gap of greater than 0.5 mm .020 inch.

Contact Operation Table

The table below shows the state of the other contacts when the current through the welded form "a" contact is 0 V and the rated voltage is applied through the form "b" contact.

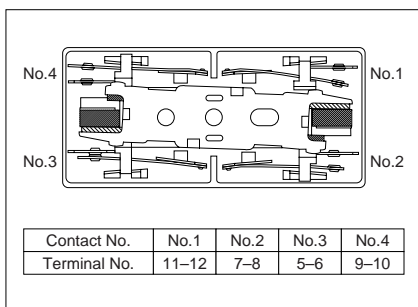

Contact No.		State of other contacts			
		1	2	3	4
Welded terminal No.	1			>0.5	
	2			>0.5	
	3	>0.5	>0.5		>0.5
	4			>0.5	

>0.5: contact gap is kept at min. 0.5 mm .020 inch
Empty cells: either closed or open

Note: Contact gaps are shown at the initial state. If the contacts change state owing to loading/breaking it is necessary to check the actual loading.

3) 4a4b Type

Internal Contacts Weld

If the internal contacts (nos. 2, 3, 6, and 7) weld, the armature becomes non-operational and the contact gaps of each of the four form "a" contacts are maintained at greater than 0.5 mm .020 inch. Reliable isolation is thus ensured.

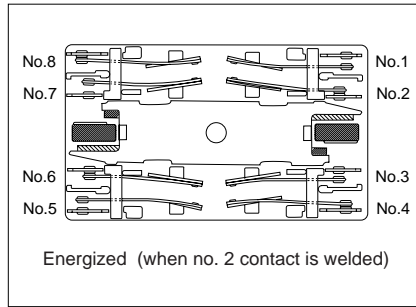
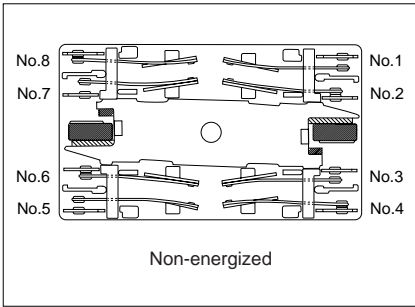

If the No. 2 contact welds. Each of the four form "a" contacts (Nos. 1, 3, 5, and 7) maintains a gap of greater than 0.5 mm .020 inch.

External Contacts Weld

If the external contacts (nos. 1, 4, 5, and 8) weld, gaps of greater than 0.5 mm .020 inch are maintained between adjacent contacts and the coil returns to a non-energized state.

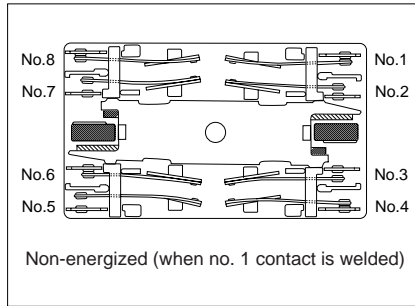
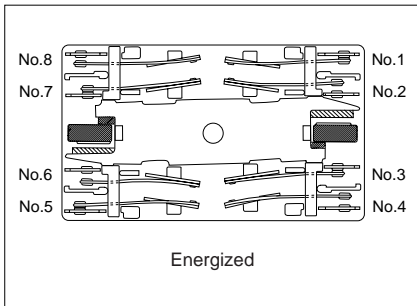

If the No. 1 contact welds. The adjacent No. 2 contact maintains a gap of greater than 0.5 mm .020 inch. The other contacts, because the coil is not energized, return to their normal return state; each of form "a" contacts (nos. 3, 5, and 7) maintains a contact gap of greater than 0.5 mm .020 inch; each of the form "b" contacts (nos. 4, 6, and 8) return to a closed state.

If external connections are made in series. Even if one of the contacts welds, because the other contacts operate independently, the contact gaps are maintained at greater than 0.5 mm .020 inch.

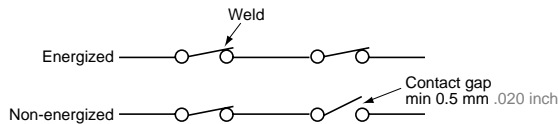

Contact Operation Table

The table below shows the state of the other contacts when the current through the welded form "a" contact is 0 V and the rated voltage is applied through the form "b" contact.

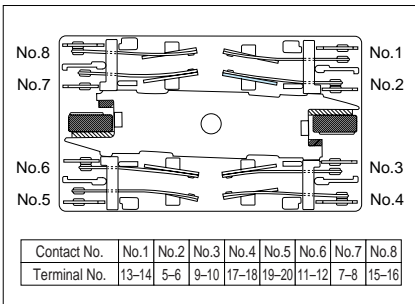

Contact No.		State of other contacts							
Contact No.		1	2	3	4	5	6	7	8
Welded terminal No.	1		>0.5	>0.5	≠	>0.5	≠	>0.5	≠
	2	>0.5		>0.5		>0.5		>0.5	
	3	>0.5	>0.5		>0.5		>0.5		>0.5
	4	≠	>0.5	>0.5		≠	>0.5	≠	>0.5
	5	>0.5	≠	>0.5	≠		>0.5	>0.5	≠
	6	>0.5		>0.5		>0.5		>0.5	
	7		>0.5		>0.5		>0.5		>0.5
	8	≠	>0.5	≠	>0.5	≠	>0.5	>0.5	

>0.5: contact gap is kept at min. 0.5 mm .020 inch
 ≠: contact closed
 Empty cells: either closed or open

Note: Contact gaps are shown at the initial state.
 If the contacts change state owing to loading/breaking it is necessary to check the actual loading.

For Cautions for Use, see Relay Technical Information (Page 48 to 76).