

Features

- Low Forward Voltage Drop
- Guard Ring Construction for Transient Protection
- Low Capacitance
- Ultra-Small Surface Mount Package
- **Lead Free By Design/RoHS Compliant (Note 1)**
- **"Green" Device (Note 2)**
- **Qualified to AEC-Q101 Standards for High Reliability**

Mechanical Data

- Case: DFN1006-2
- Case Material: Molded Plastic, "Green" Molding Compound. UL Flammability Classification Rating 94V-0
- Moisture Sensitivity: Level 1 per J-STD-020D
- Terminal Connections: Cathode Dot
- Terminals: Finish — NiPdAu annealed over Copper leadframe. Solderable per MIL-STD-202, Method 208
- Marking Information: See Page 2
- Ordering Information: See Page 2
- Weight: 0.001 grams (approximate)

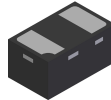

Top View

Maximum Ratings @T_A = 25°C unless otherwise specified

Characteristic	Symbol	Value	Unit
Peak Repetitive Reverse Voltage	V _{RRM}	30	V
Working Peak Reverse Voltage	V _{RWM}		
DC Blocking Voltage	V _R		
RMS Reverse Voltage	V _{R(RMS)}	21	V
Maximum (Peak) Forward Current	I _{FM}	200	mA
Peak Forward Surge Current	I _{FSM}	1.0	A

Thermal Characteristics

Characteristic	Symbol	Value	Unit
Power Dissipation	P _D	250	mW
Thermal Resistance, Junction to Ambient Air	R _{θJA}	400	°C/W
Operating and Storage Temperature Range	T _J , T _{STG}	-65 to +125	°C

Electrical Characteristics @T_A = 25°C unless otherwise specified

Characteristic	Symbol	Min	Typ	Max	Unit	Test Conditions
Reverse Breakdown Voltage (Note 3)	V _{(BR)R}	30	—	—	V	I _R = 150μA
Forward Voltage Drop	V _F	—	—	350 575	mV	I _F = 20mA I _F = 200mA
Peak Reverse Current (Note 3)	I _R	—	—	150 30	μA	V _R = 30V V _R = 10V
Total Capacitance	C _T	—	20	—	pF	V _R = 0V, f = 1.0MHz

- Note: 1. No purposefully added lead.
 2. Diodes Inc.'s "Green" policy can be found on our website at http://www.diodes.com/products/lead_free/index.php.
 3. Short duration pulse test used to minimize self-heating effect.

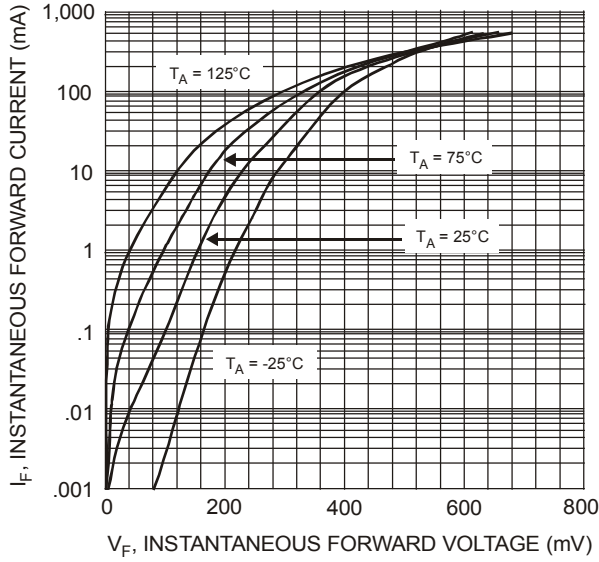

Fig. 1 Typical Forward Characteristics

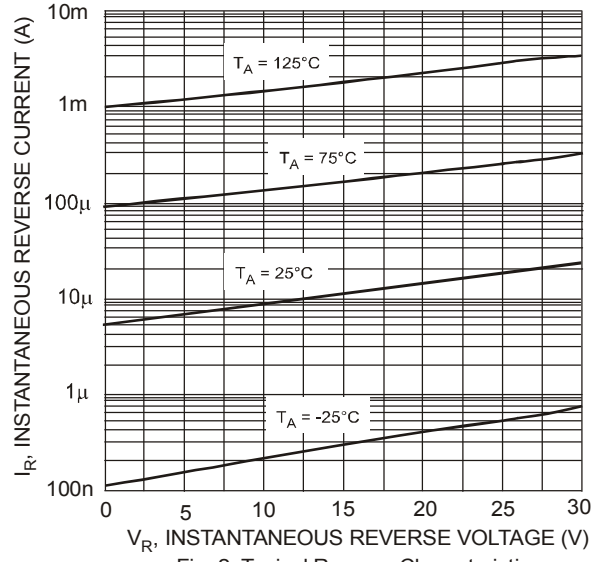

Fig. 2 Typical Reverse Characteristics

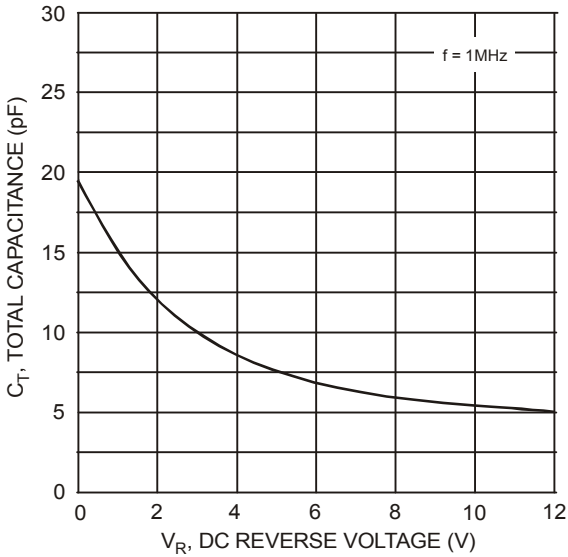

Fig. 3 Total Capacitance vs. Reverse Voltage

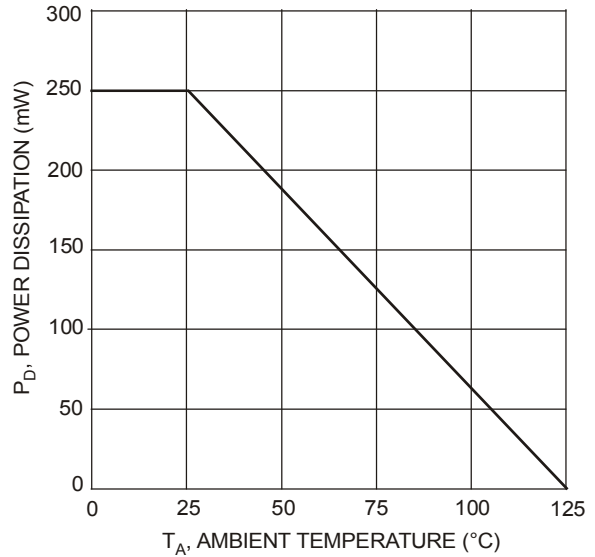

Fig. 4 Power Derating Curve

Ordering Information (Note 4)

Device	Packaging	Shipping
SDM20U30LP-7	DFN1006-2	3000/Tape & Reel

Notes: 4. For packaging details, go to our website at <http://www.diodes.com/datasheets/ap02007.pdf>.

Marking Information

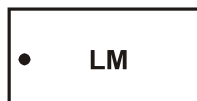

LM = Product Type Marking Code, Dot Denotes Cathode Side

Package Outline Dimensions

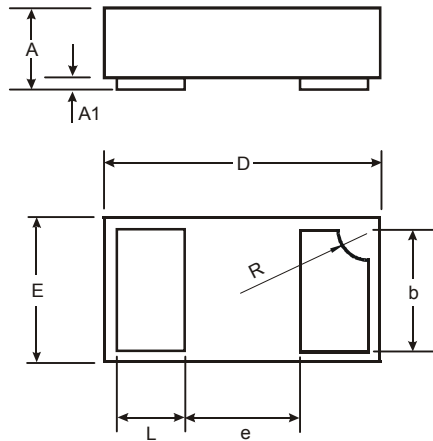

DFN1006-2			
Dim	Min	Max	Typ
A	0.47	0.53	0.50
A1	0	0.05	0.03
b	0.45	0.55	0.50
D	0.95	1.075	1.00
E	0.55	0.675	0.60
e	-	-	0.40
L	0.20	0.30	0.25
R	0.05	0.15	0.10
All Dimensions in mm			

Suggested Pad Layout

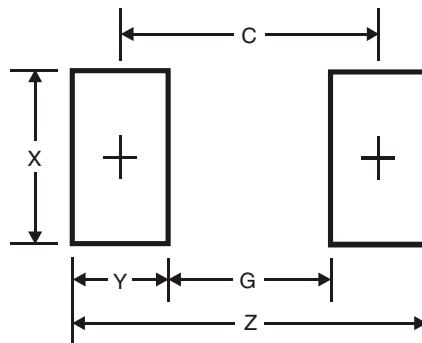

Dimensions	Value (in mm)
Z	1.1
G	0.3
X	0.7
Y	0.4
C	0.7

IMPORTANT NOTICE

Diodes Incorporated and its subsidiaries reserve the right to make modifications, enhancements, improvements, corrections or other changes without further notice to any product herein. Diodes Incorporated does not assume any liability arising out of the application or use of any product described herein; neither does it convey any license under its patent rights, nor the rights of others. The user of products in such applications shall assume all risks of such use and will agree to hold Diodes Incorporated and all the companies whose products are represented on our website, harmless against all damages.

LIFE SUPPORT

Diodes Incorporated products are not authorized for use as critical components in life support devices or systems without the expressed written approval of the President of Diodes Incorporated.