

### Absolute maximum ratings

( $T_a=25^\circ\text{C}$ )

Symbol	Ratings	Unit
$V_{CBO}$	-60	V
$V_{CEO}$	-60	V
$V_{EBO}$	-6	V
$I_c$	-4	A
$I_{cP}$	-6 (PW $\leq$ 1ms, Du $\leq$ 50%)	A
$I_B$	-0.5	A
$P_T$	2.6 ( $T_a=25^\circ\text{C}$ )	W
$T_j$	150	$^\circ\text{C}$
$T_{stg}$	-40 to +150	$^\circ\text{C}$

### Equivalent circuit diagram

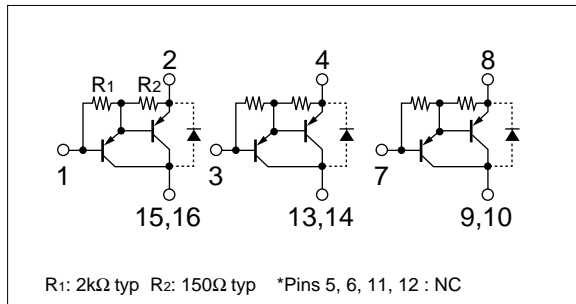

### Electrical characteristics

( $T_a=25^\circ\text{C}$ )

Symbol	Specification			Unit	Conditions
	min	typ	max		
$I_{CBO}$			-10	$\mu\text{A}$	$V_{CB}=-60\text{V}$
$I_{EBO}$			-10	mA	$V_{EB}=-6\text{V}$
$V_{CEO}$	-60			V	$I_c=-10\text{mA}$
$h_{FE}$	2000		12000		$V_{CE}=-4\text{V}$ , $I_c=-3\text{A}$
$V_{CE(sat)}$			-1.5	V	$I_c=-3\text{A}$ , $I_B=-6\text{mA}$
$V_{BE(sat)}$			-2.0	V	
$V_{FEC}$			1.8	V	$I_{FEC}=1\text{A}$
$t_{on}$		0.4		$\mu\text{s}$	$V_{CC}=-30\text{V}$ , $I_c=-3\text{A}$ ,
$t_{stg}$		0.8		$\mu\text{s}$	$I_c=-3\text{A}$ ,
$t_f$		0.6		$\mu\text{s}$	$I_{B1}=-I_{B2}=-10\text{mA}$
$f_T$		200		MHz	$V_{CE}=-12\text{V}$ , $I_E=0.2\text{A}$
$C_{ob}$		75		pF	$V_{CB}=-10\text{V}$ , $f=1\text{MHz}$

### Characteristic curves

$I_c$ - $V_{CE}$  Characteristics (Typical)

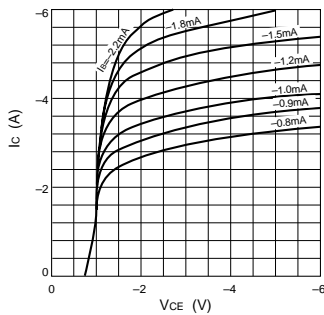

$h_{FE}$ - $I_c$  Characteristics (Typical)

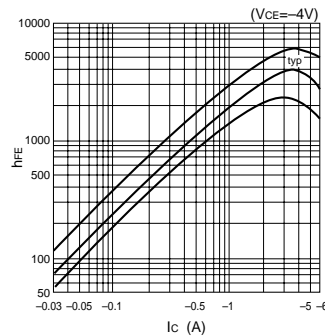

$h_{FE}$ - $I_c$  Temperature Characteristics (Typical)

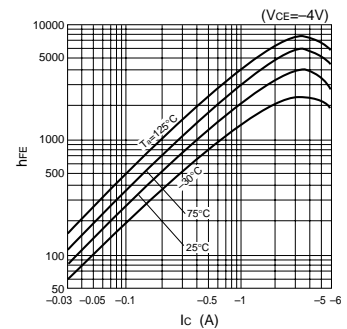

$V_{CE(sat)}$ - $I_c$  Temperature Characteristics (Typical)

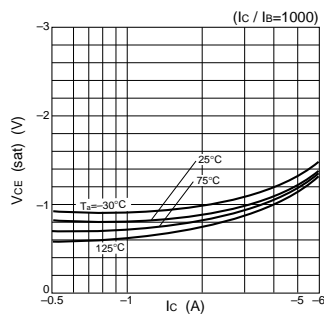

$V_{CE(sat)}$ - $I_B$  Characteristics (Typical)

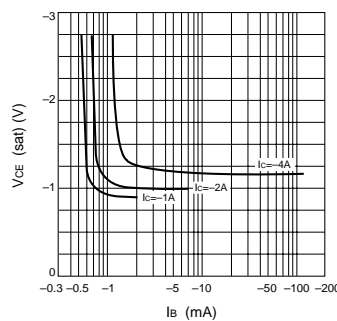

$I_c$ - $V_{BE}$  Temperature Characteristics (Typical)

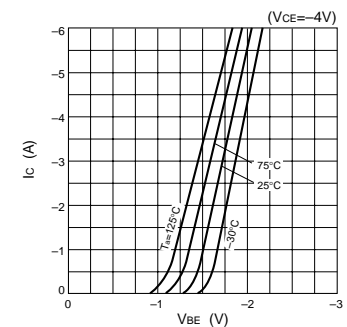

$\theta_{j-a}$ -PW Characteristics

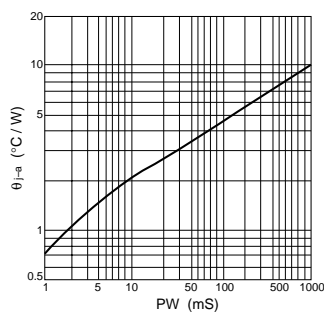

$P_T$ - $T_a$  Characteristics

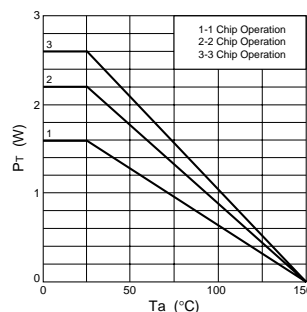

Safe Operating Area (SOA)

