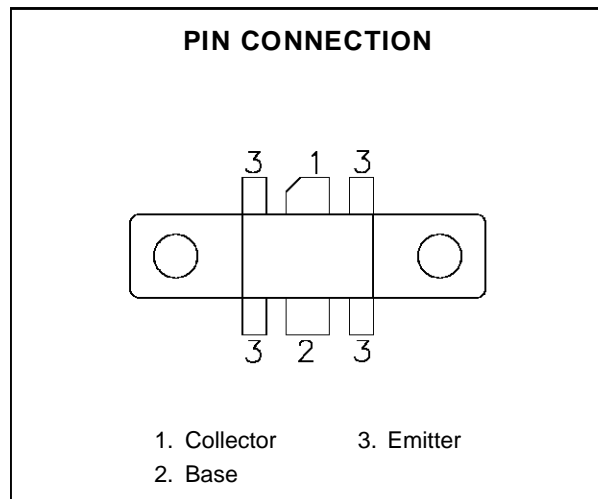
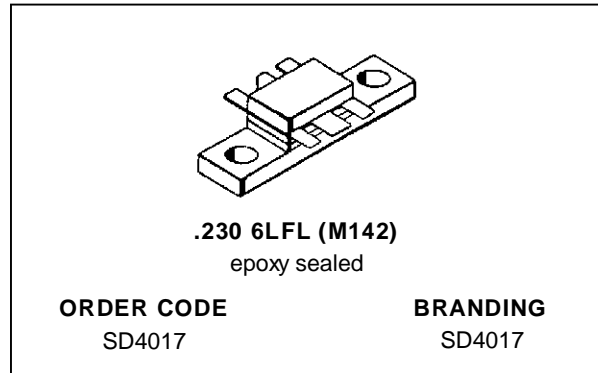

RF & MICROWAVE TRANSISTORS 806-960 MHz CELLULAR BASE STATIONS

- GOLD METALLIZATION
- DIFFUSED EMITTER BALLASTING
- INTERNAL INPUT MATCHING
- DESIGNED FOR LINEAR OPERATION
- HIGH SATURATED POWER CAPABILITY
- COMMON EMITTER CONFIGURATION
- $P_{OUT} = 30$ W MIN. WITH 7.5 dB GAIN
- $\eta_C = 55\%$ TYPICAL
- TYPICAL LOAD MISMATCH CAPABILITY:
20:1 ALL ANGLES RATED CONDITIONS
10:1 ALL ANGLES @ $\pm 20\%$ RATED VOLTAGE
- TYPICAL OVERDRIVE SURVIVABILITY
5 dB

DESCRIPTION

The SD4017 is a gold metallized epitaxial silicon NPN planar transistor using diffused emitter ballast resistors for high linearity class AB operation for cellular base station applications.

ABSOLUTE MAXIMUM RATINGS ($T_{case} = 25^{\circ}C$)

Symbol	Parameter	Value	Unit
V_{CBO}	Collector-Base Voltage	48	V
V_{CEO}	Collector-Emitter Voltage	25	V
V_{EBO}	Collector-Supply Voltage	3.5	V
P_{DISS}	Power Dissipation	88	W
I_C	Device Current	7.5	A
T_J	Junction Temperature	200	$^{\circ}C$
T_{STG}	Storage Temperature	- 65 to +150	$^{\circ}C$

THERMAL DATA

$R_{TH(j-c)}$	Junction-Case Thermal Resistance	2.0	$^{\circ}C/W$
---------------	----------------------------------	-----	---------------

SD4017**ELECTRICAL SPECIFICATIONS** ($T_{\text{case}} = 25^{\circ}\text{C}$)

STATIC

Symbol	Test Conditions	Value			Unit
		Min.	Typ.	Max.	
BV_{CBO}	$I_{\text{C}} = 100 \text{ mA}$	48	55	—	V
BV_{EBO}	$I_{\text{E}} = 10 \text{ mA}$	3.5	5	—	V
BV_{CEO}	$I_{\text{C}} = 40 \text{ mA}$	25	28	—	V
BV_{CER}	$I_{\text{C}} = 40 \text{ mA}$ $R_{\text{BE}} = 150 \ \Omega$	30	40	—	V
I_{CBO}	$V_{\text{CE}} = 24 \text{ V}$	10	—	—	mA
h_{FE}	$V_{\text{CE}} = 20 \text{ V}$ $I_{\text{C}} = 2 \text{ A}$	15	40	100	—

DYNAMIC

Symbol	Test Conditions	Value			Unit
		Min.	Typ.	Max.	
P_{OUT}	$f = 860 \text{ MHz}$ $V_{\text{CE}} = 25 \text{ V}$ $I_{\text{CQ}} = 60 \text{ mA}$	30	—	—	W
η_{c}	$f = 860 \text{ MHz}$ $V_{\text{CE}} = 25 \text{ V}$ $I_{\text{CQ}} = 60 \text{ mA}$	—	55	—	%
P_{G}	$f = 860 \text{ MHz}$ $V_{\text{CE}} = 25 \text{ V}$ $I_{\text{CQ}} = 60 \text{ mA}$	7.5	9	—	dB
C_{OB}	$V_{\text{CB}} = 25 \text{ V}$ $f_{\text{o}} = 1 \text{ MHz}$	—	42	—	pf
IMD_3	$P_{\text{OUT}} = 30 \text{ WPEP}$ $f_1 = 860.0 \text{ MHz}$ $f_2 = 860.1 \text{ MHz}$	—	-35	—	dBc
VSWR_1	$\text{VSWR} = 20:1$ $V_{\text{CE}} = 25 \text{ V}$ $\text{VSWR} = 10:1$ $V_{\text{CE}} = 25 \text{ V} \pm 20\%$	No Degradation in Output Device			Typ.
VSWR_2	$\text{VSWR} = 5:1$ $V_{\text{CE}} = 25 \text{ V} \pm 20\%$ $P_{\text{IN}} = P_{\text{IN}}(\text{norm}) + 3\text{dB}$	No Degradation in Output Device			Typ.
OVD	$P_{\text{IN}}(\text{norm}) = +5\text{dB}$ $V_{\text{CE}} = 25 \text{ V}$ $P_{\text{IN}}(\text{norm}) = +3\text{dB}$ $V_{\text{CE}} = 25 \text{ V} \pm 20\%$	No Degradation in Output Device			Typ.

TYPICAL PERFORMANCE

DC CURRENT GAIN vs COLLECTOR CURRENT

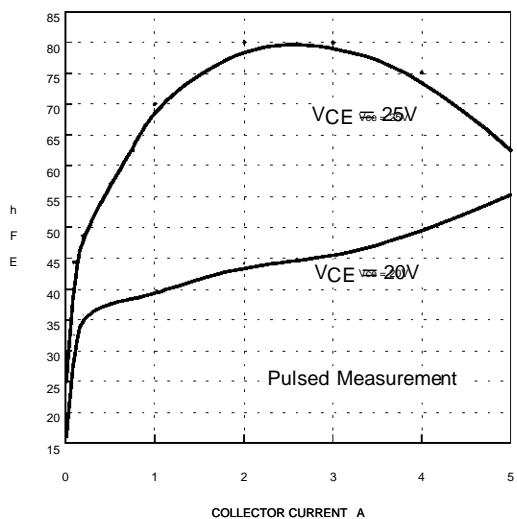

OUTPUT CAPACITANCE vs C-B VOLTAGE

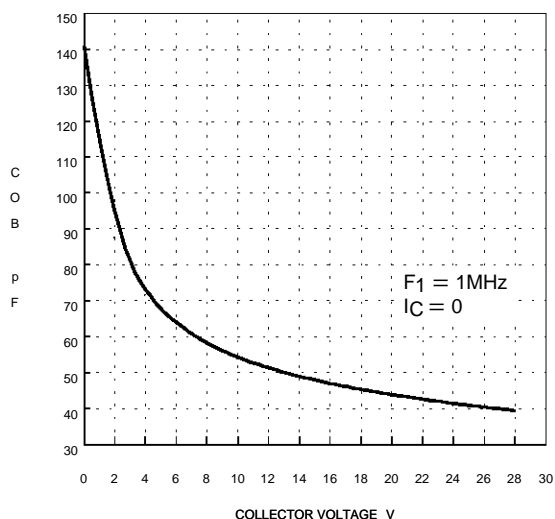

DC SAFE OPERATING AREA

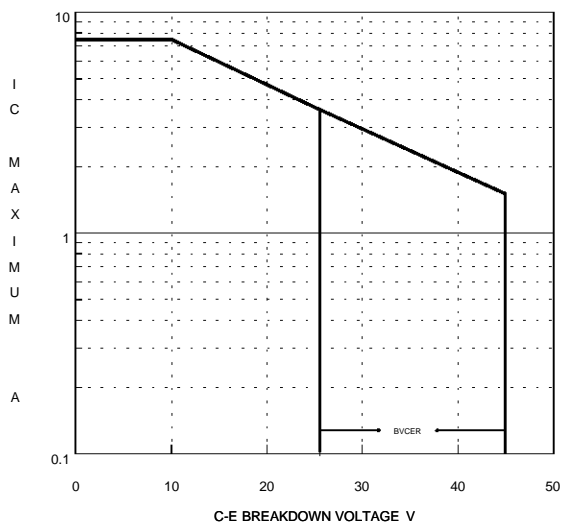

POWER GAIN vs CASE TEMPERATURE

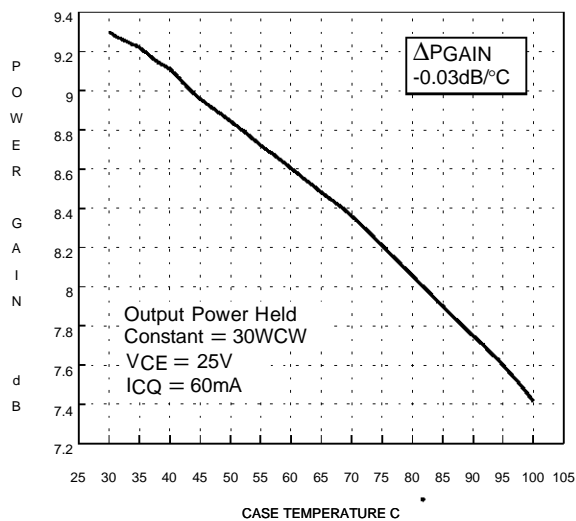

TYPICAL PERFORMANCE (cont'd)

OUTPUT POWER vs INPUT POWER

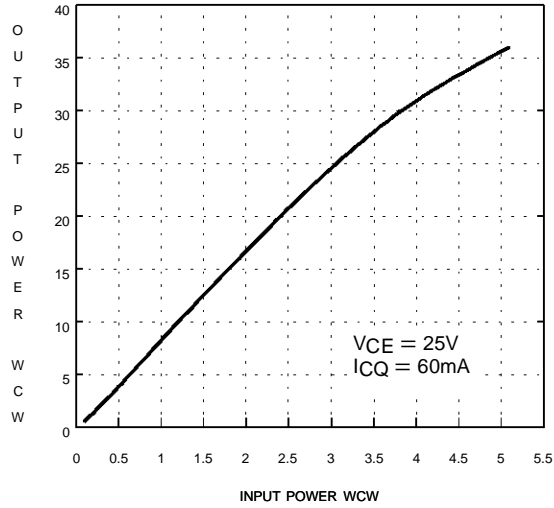

OUTPUT POWER & GAIN vs VOLTAGE

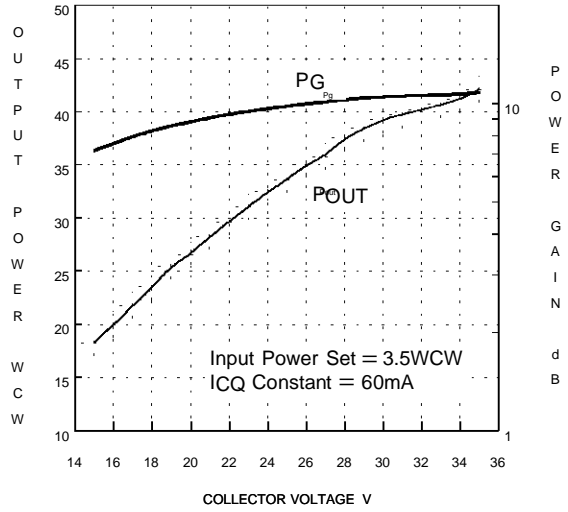

IM DISTORTION vs OUTPUT POWER

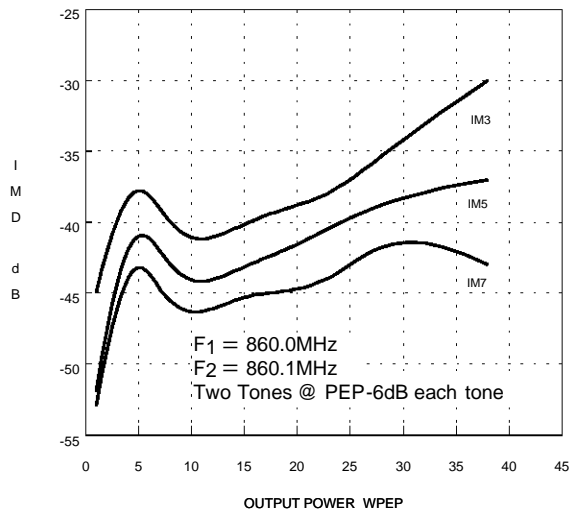

IM3 DISTORTION vs SUPPLY VOLTAGE

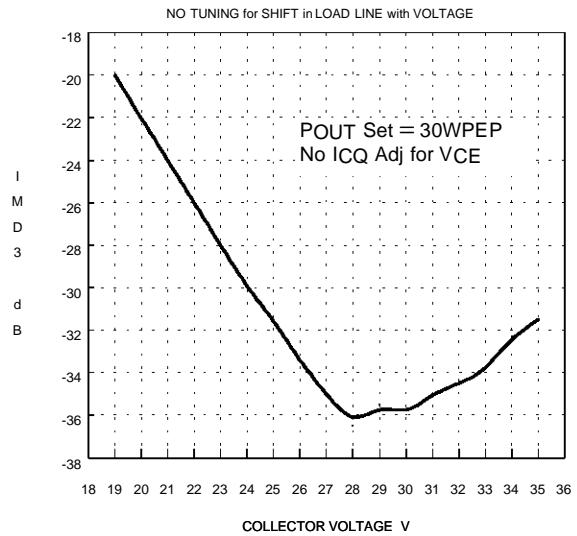

IMPEDANCE DATA

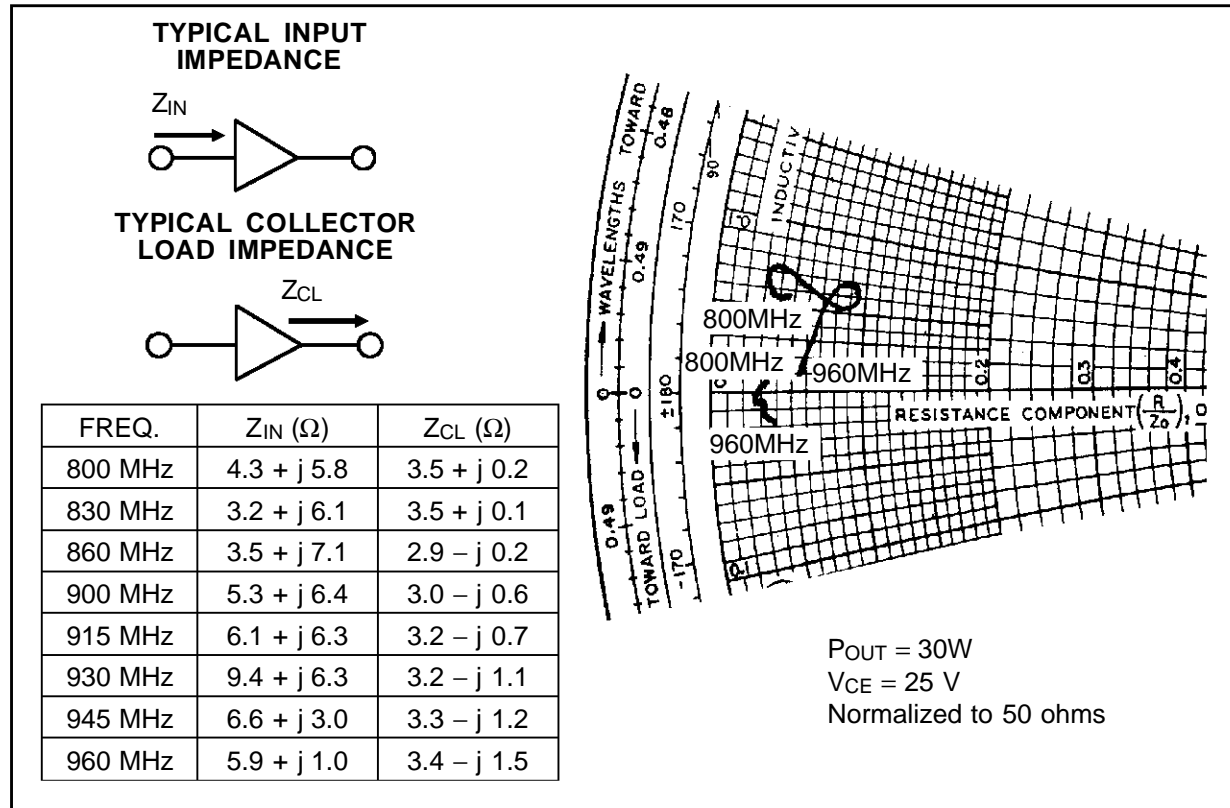

TEST CIRCUIT

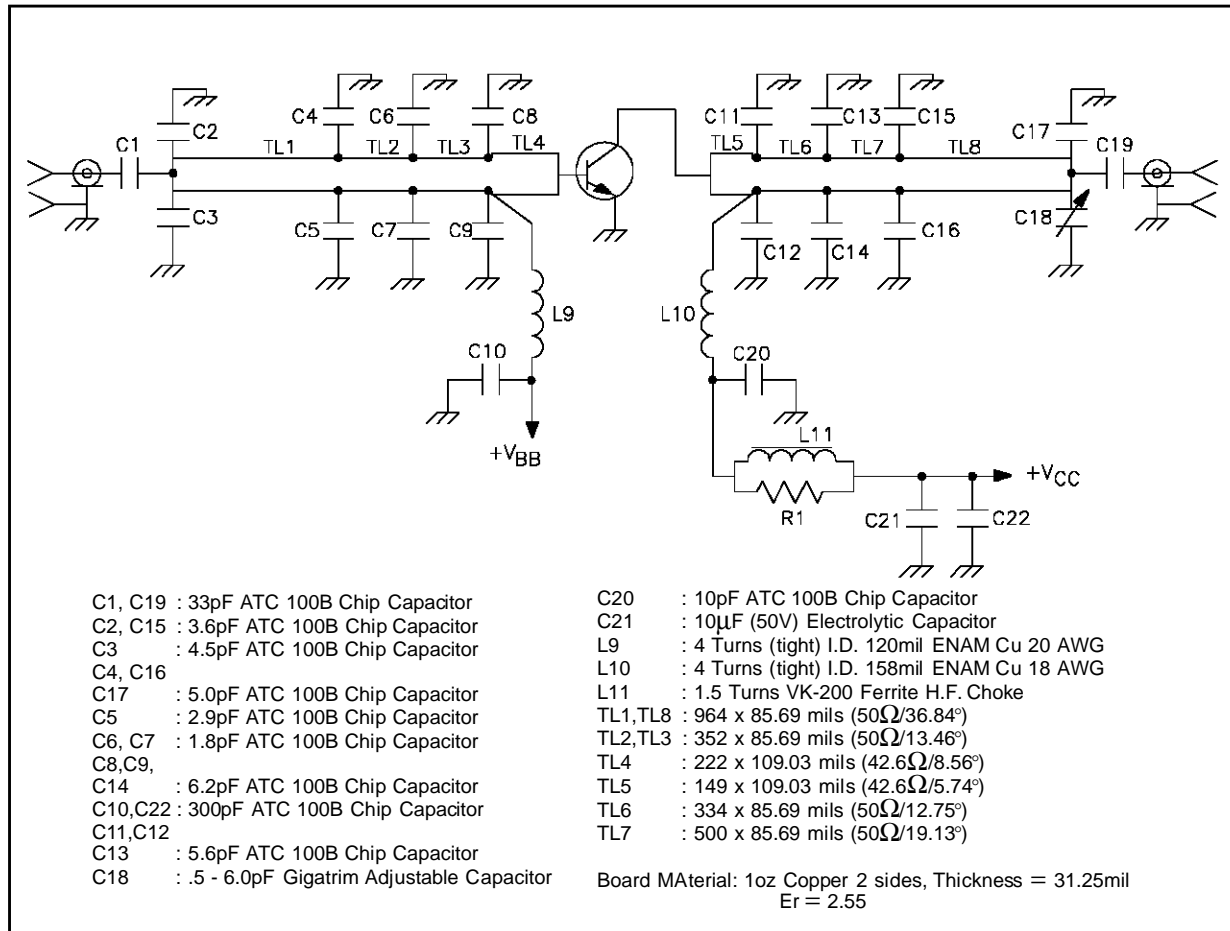

BOARD LAYOUT

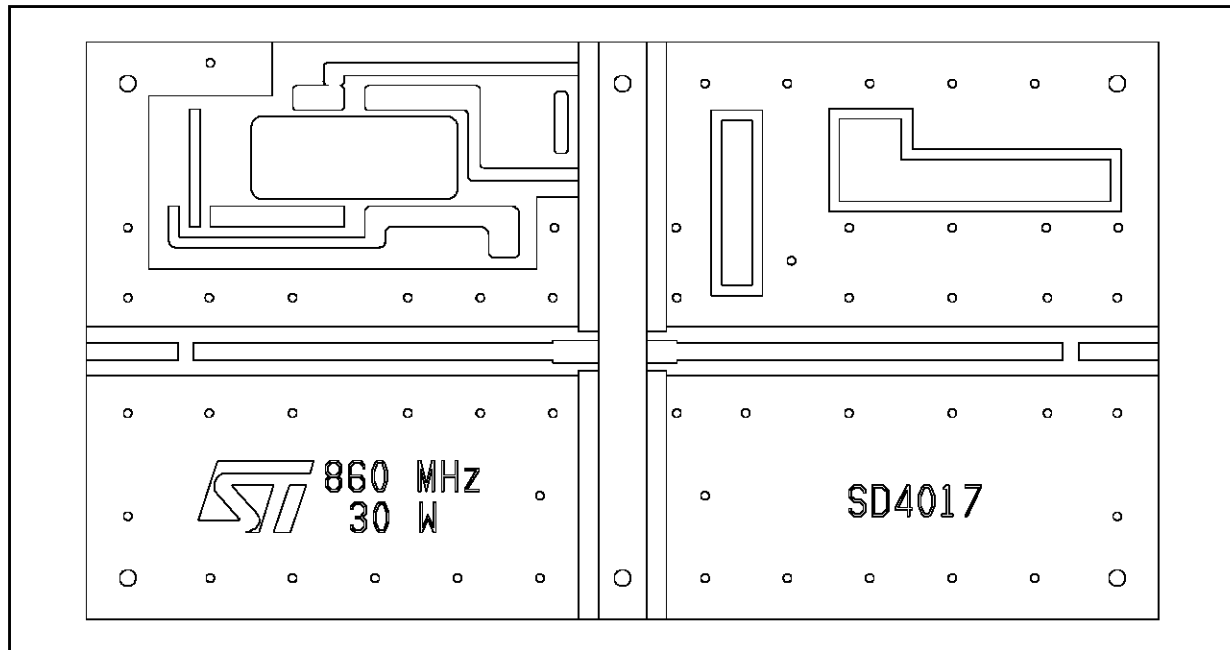

PACKAGE MECHANICAL DATA

Ref. Dwg.No. 12-0142 rev. C

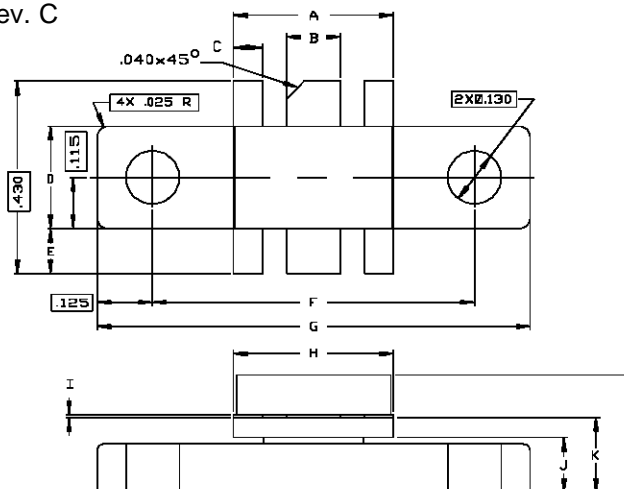

SGS-THOMSON MICROELECTRONICS			CONT'D		
	MINIMUM Inches/mm	MAXIMUM Inches/mm		MINIMUM Inches/mm	MAXIMUM Inches/mm
A	.355/9,02	.365/9,27	K	.160/4,06	.180/4,57
B	.115/2,92	.125/3,18	L	.230/5,84	.260/6,60
C	.075/1,91	.085/2,16			
D	.225/5,72	.235/5,97			
E	.090/2,29	.110/2,79			
F	.720/18,29	.730/18,54			
G	.970/24,64	.980/24,89			
H	.355/9,02	.365/9,27			
I	.004/0,10	.006/0,15			
J	.120/3,05	.130/3,30			

Information furnished is believed to be accurate and reliable. However, SGS-THOMSON Microelectronics assumes no responsibility for the consequences of use of such information nor for any infringement of patents or other rights of third parties which may result from its use. No license is granted by implication or otherwise under any patent or patent rights of SGS-THOMSON Microelectronics. Specifications mentioned in this publication are subject to change without notice. This publication supersedes and replaces all information previously supplied. SGS-THOMSON Microelectronics products are not authorized for use as critical components in life support devices or systems without express written approval of SGS-THOMSON Microelectronics.

©1994 SGS-THOMSON Microelectronics - All Rights Reserved

SGS-THOMSON Microelectronics GROUP OF COMPANIES

Australia - Brazil - France - Germany - Hong Kong - Italy - Japan - Korea - Malaysia - Malta - Morocco - The Netherlands - Singapore - Spain - Sweden - Switzerland - Taiwan - Thailand - United Kingdom - U.S.A.