

FAST RECOVERY DIODES

Stud Version

Features

- High power FAST recovery diode series
- 1.0 to 2.0 μ s recovery time
- High voltage ratings up to 2500V
- High current capability
- Optimized turn on and turn off characteristics
- Low forward recovery
- Fast and soft reverse recovery
- Compression bonded encapsulation
- Stud version JEDEC DO-30
- Maximum junction temperature 125°C

110A

Typical Applications

- Snubber diode for GTO
- High voltage free-wheeling diode
- Fast recovery rectifier applications

Major Ratings and Characteristics

Parameters	SD103N/R	Units
$I_{F(AV)}$	110	A
@ T_C	85	°C
$I_{F(RMS)}$	173	A
I_{FSM} @ 50Hz	3570	A
@ 60Hz	3730	A
I^2t @ 50Hz	64	KA ² s
@ 60Hz	58	KA ² s
V_{RRM} range	400 to 2500	V
t_{rr} range	1.0 to 2.0	μ s
@ T_J	25	°C
T_J	- 40 to 125	°C

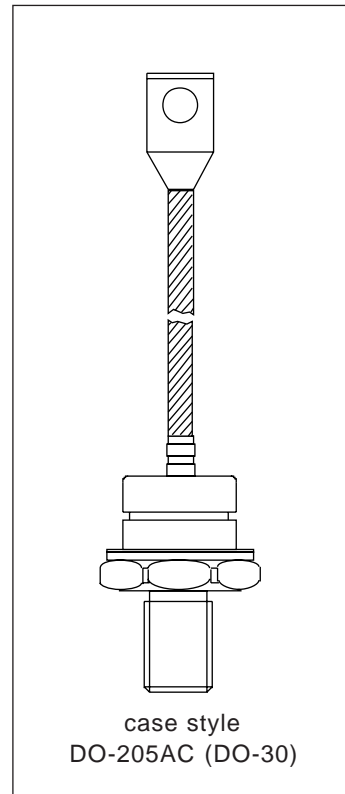

ELECTRICAL SPECIFICATIONS

Voltage Ratings

Type number	Voltage Code	V _{RRM} max. repetitive peak and off-state voltage V	V _{RSM} , maximum non-repetitive peak voltage V	I _{RRM} max. T _J = 125°C mA
SD103N/R..S10	04	400	500	35
	08	800	900	
	10	1000	1100	
SD103N/R..S15	12	1200	1300	
	14	1400	1500	
	16	1600	1700	
SD103N/R..S20	20	2000	2100	
	25	2500	2600	

Forward Conduction

Parameter	SD103N/R	Units	Conditions
I _{F(AV)} Max. average forward current @ Case temperature	110	A	180° conduction, half sine wave.
	85	°C	
I _{F(RMS)} Max. RMS current	173	A	DC @ 75°C case temperature
I _{FSM} Max. peak, one-cycle non-repetitive forward current	3570	A	t = 10ms No voltage
	3730		t = 8.3ms reapplied
	3000		t = 10ms 100% V _{RRM}
	3140		t = 8.3ms reapplied
I ² t Maximum I ² t for fusing	64	KA ² s	t = 10ms No voltage
	58		t = 8.3ms reapplied
	45		t = 10ms 100% V _{RRM}
	41		t = 8.3ms reapplied
I ² √t Maximum I ² √t for fusing	636	KA ² √s	t = 0.1 to 10ms, no voltage reapplied
V _{F(TO)1} Low level of threshold voltage	1.36	V	(16.7% × π × I _{F(AV)}) < I < π × I _{F(AV)} , T _J = T _J max.
V _{F(TO)2} High level of threshold voltage	1.94		(I > π × I _{F(AV)}), T _J = T _J max.
r _{f1} Low level of forward slope resistance	2.55	mΩ	(16.7% × π × I _{F(AV)}) < I < π × I _{F(AV)} , T _J = T _J max.
r _{f2} High level of forward slope resistance	1.11		(I > π × I _{F(AV)}), T _J = T _J max.
V _{FM} Max. forward voltage	2.23	V	I _{pk} = 345A, T _J = 25°C, t _p = 400 μs square pulse

Recovery Characteristics

Code	T _J = 25°C typical t _{rr} @ 25% I _{RRM} (μs)	Test conditions			Max. values @ T _J = 125°C		
		I _{pk} Square Pulse (A)	di/dt (A/μs)	V _r (V)	t _{rr} @ 25% I _{RRM} (μs)	Q _{rr} (μC)	I _{rr} (A)
S10	1.0	350	25	-30	1.6	21	27
S15	1.5				2.3	61	37
S20	2.0				3.2	75	39

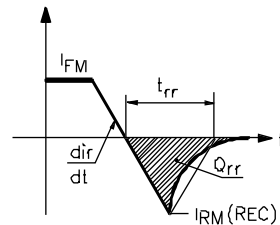

Thermal and Mechanical Specification

Parameter	SD103N/R	Units	Conditions
T _J Max. operating temperature range	-40 to 125	°C	
T _{stg} Max. storage temperature range	-40 to 150		
R _{thJC} Max. thermal resistance, junction to case	0.16	K/W	DC operation
R _{thCS} Max. thermal resistance, case to heatsink	0.10		Mounting surface, smooth, flat and greased
T Mounting torque ± 10%	15.5	Nm	Not lubricated threads
	13.5		Lubricated threads
wt Approximate weight	120	g	
Case style	DO-205AC(DO-30)		See Outline Table

ΔR_{thJC} Conduction

(The following table shows the increment of thermal resistance R_{thJC} when devices operate at different conduction angles than DC)

Conduction angle	Sinusoidal conduction	Rectangular conduction	Units	Conditions
180°	0.011	0.012	K/W	T _J = T _J max.
120°	0.016	0.019		
90°	0.021	0.023		
60°	0.029	0.030		
30°	0.041	0.041		

Ordering Information Table

Device Code

SD	10	3	R	25	S20	P	B	C
1	2	3	4	5	6	7	8	9

- 1** - Diode
- 2** - Essential part number
- 3** - 3 = Fast recovery
- 4** - N = Stud Normal Polarity (Cathode to Stud)
R = Stud Reverse Polarity (Anode to Stud)
- 5** - Voltage code: Code x 100 = V_{RRM} (see Voltage Ratings table)
- 6** - t_{rr} code (see Recovery Characteristics table)
- 7** - P = Stud base DO-205AC (DO-30) 1/2" 20UNF-2A
M = Stud base DO-205AC (DO-30) M12 X 1.75
- 8** - B = Flag top terminals (for Cathode/ Anode Leads)
S = Isolated lead with silicone sleeve
(Red = Reverse Polarity; Blue = Normal Polarity)
None = Not isolated lead
- 9** - C = Ceramic housing (over 1600V)
V = Glass-metal seal (only up to 1600V)

SD103N/R Series

Bulletin I2062 rev. B 12/96

Outline Table

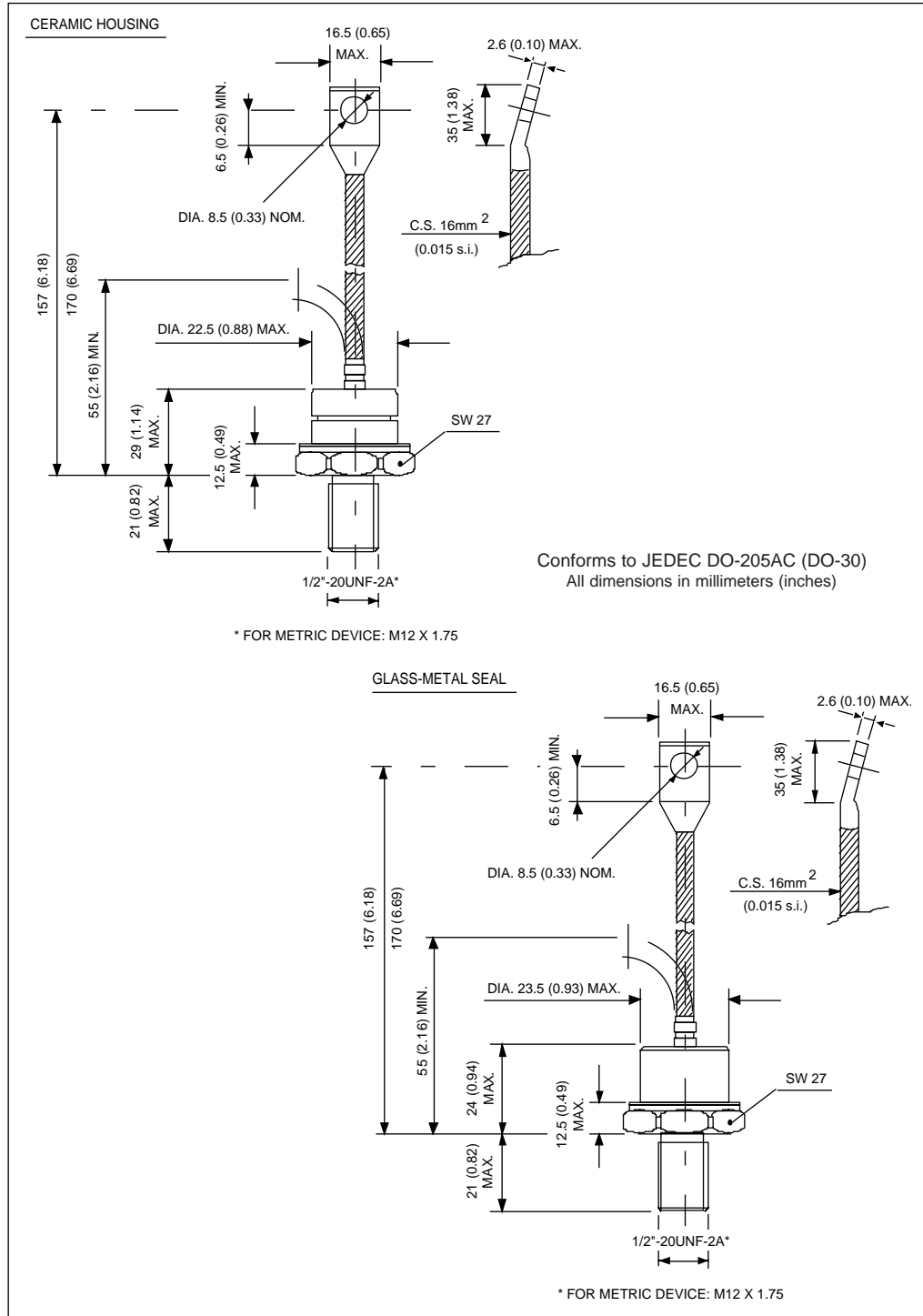

Outline Table

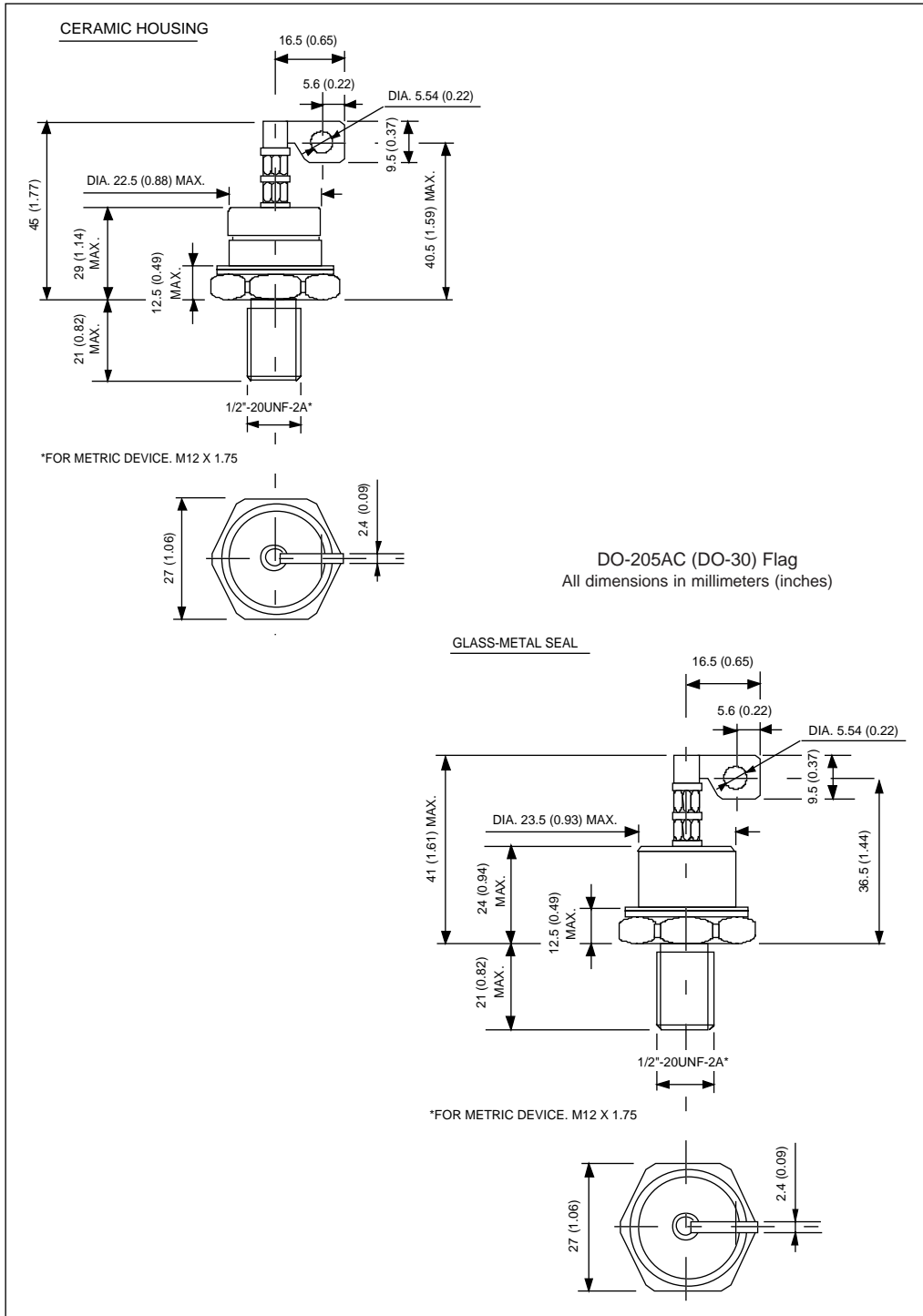

SD103N/R Series

Bulletin I2062 rev. B 12/96

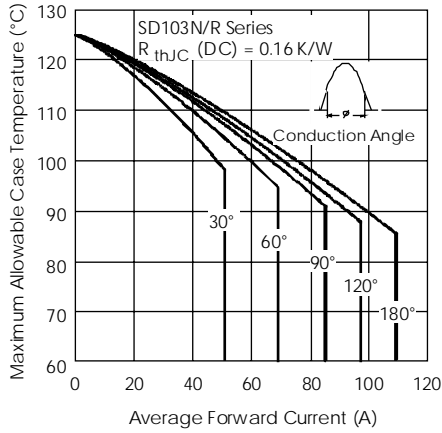

Fig. 1 - Current Ratings Characteristics

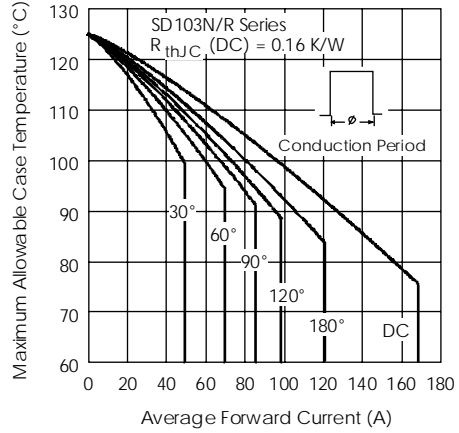

Fig. 2 - Current Ratings Characteristics

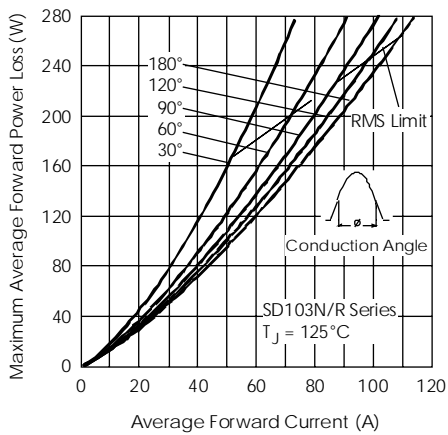

Fig. 3 - Forward Power Loss Characteristics

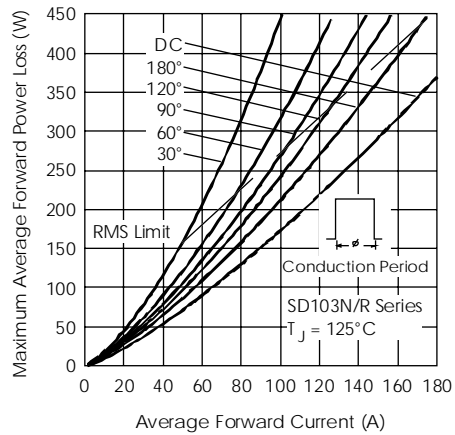

Fig. 4 - Forward Power Loss Characteristics

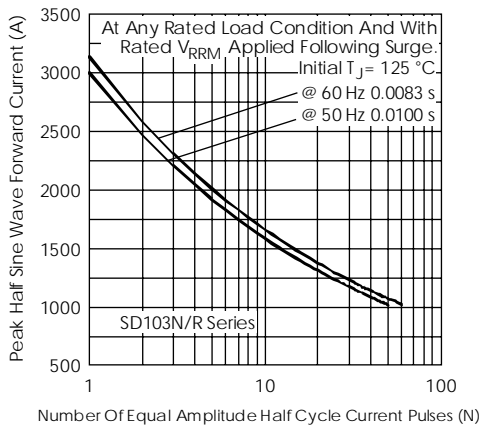

Fig. 5 - Maximum Non-repetitive Surge Current

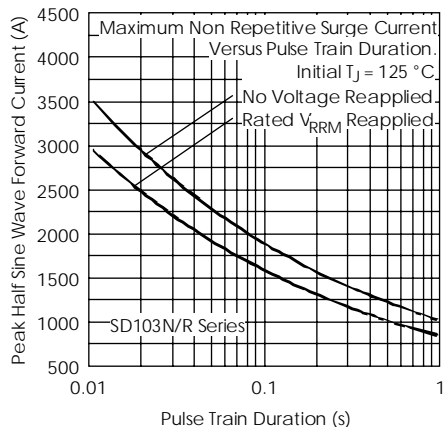

Fig. 6 - Maximum Non-repetitive Surge Current

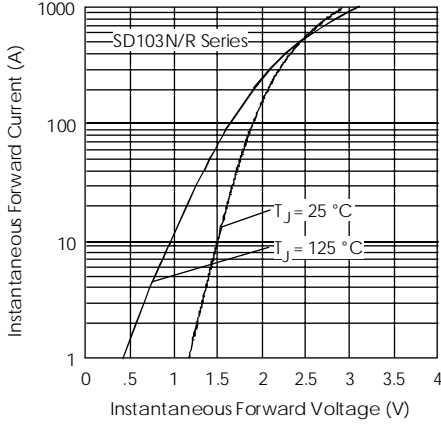

Fig. 7 - Forward Voltage Drop Characteristics

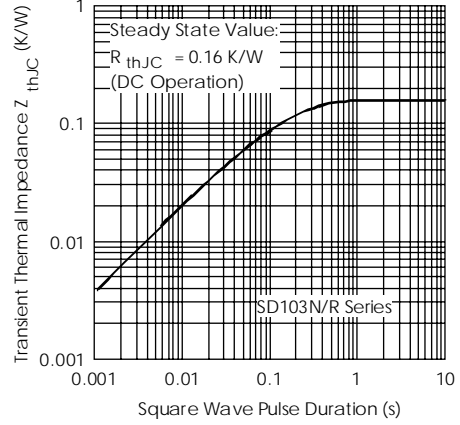

Fig. 8 - Thermal Impedance Z_{thJC} Characteristic

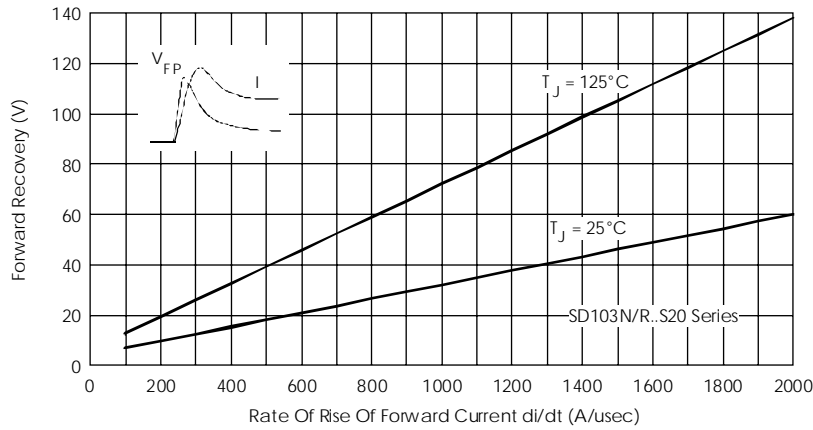

Fig. 9 - Typical Forward Recovery Characteristics

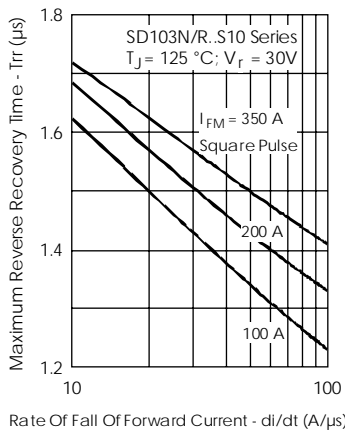

Fig. 10 - Recovery Time Characteristics

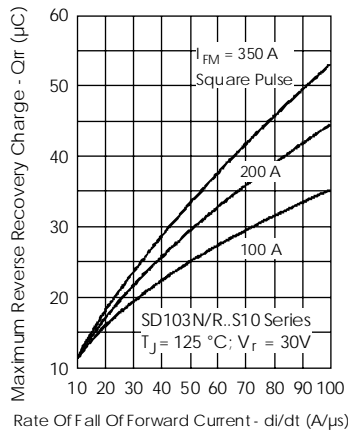

Fig. 11 - Recovery Charge Characteristics

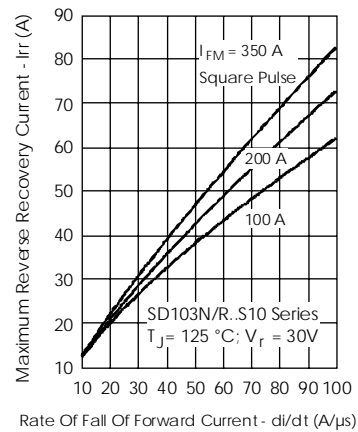

Fig. 12 - Recovery Current Characteristics

SD103N/R Series

Bulletin I2062 rev. B 12/96

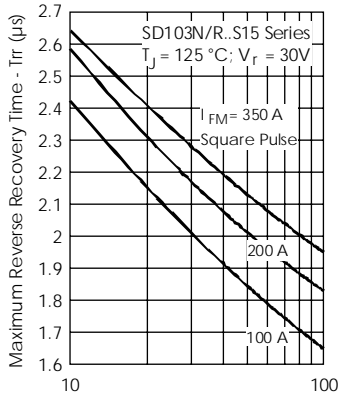

Fig. 13 - Recovery Time Characteristics

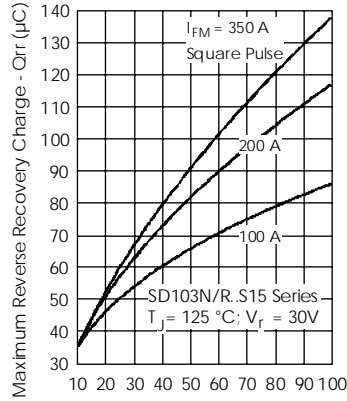

Fig. 14 - Recovery Charge Characteristics

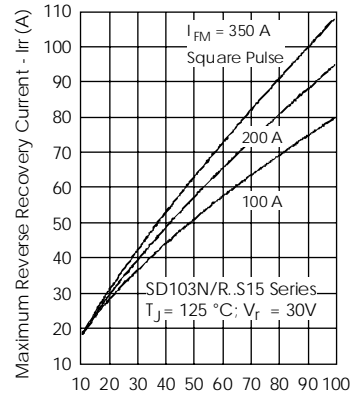

Fig. 15 - Recovery Current Characteristics

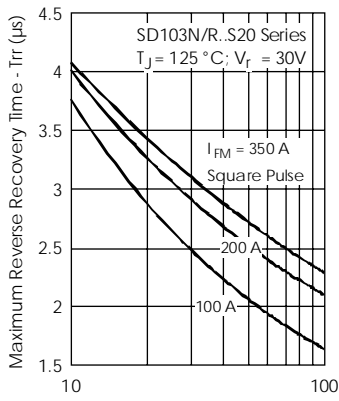

Fig. 16 - Recovery Time Characteristics

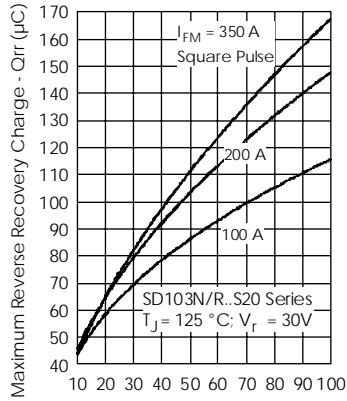

Fig. 17 - Recovery Charge Characteristics

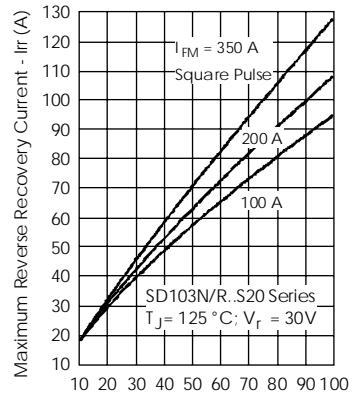

Fig. 18 - Recovery Current Characteristics

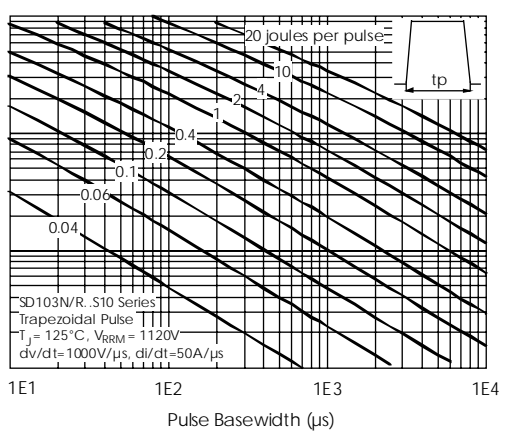
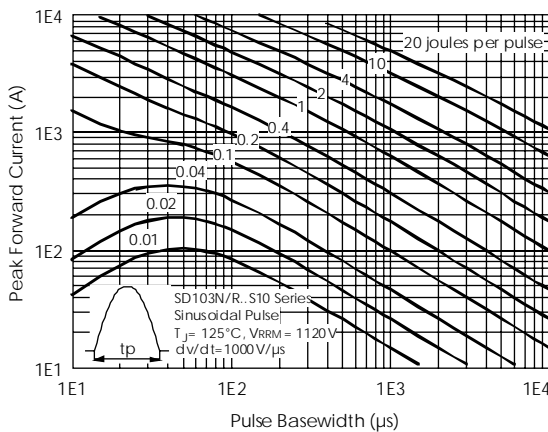

Fig. 19 - Maximum Total Energy Loss Per Pulse Characteristics

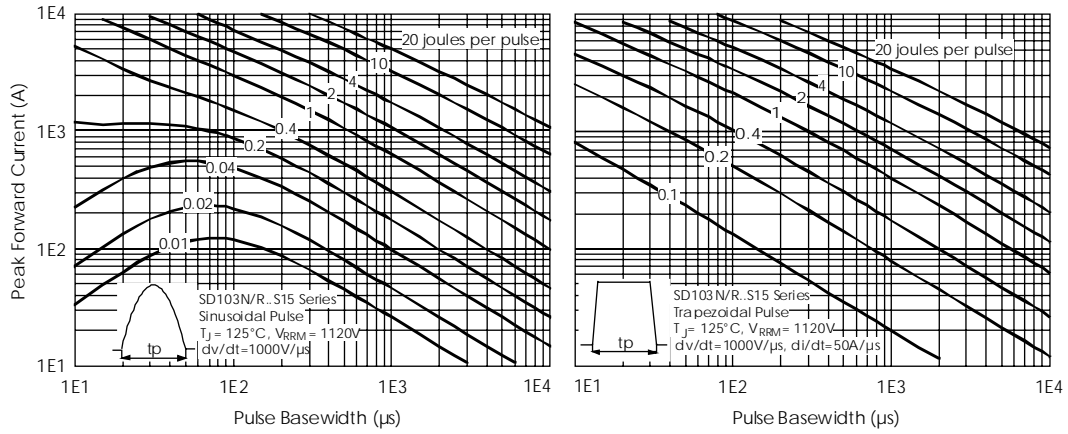

Fig. 20 - Maximum Total Energy Loss Per Pulse Characteristics

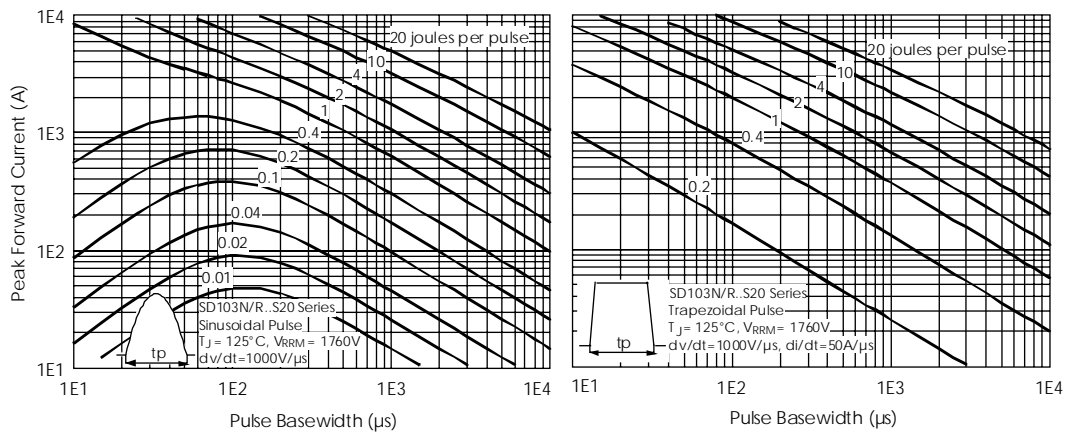

Fig. 21 - Maximum Total Energy Loss Per Pulse Characteristics