

SBL1030CT AND SBL1040CT

SCHOTTKY RECTIFIER

Reverse Voltage - 30 and 40 Volts Forward Current - 10.0 Amperes

TO-220AB

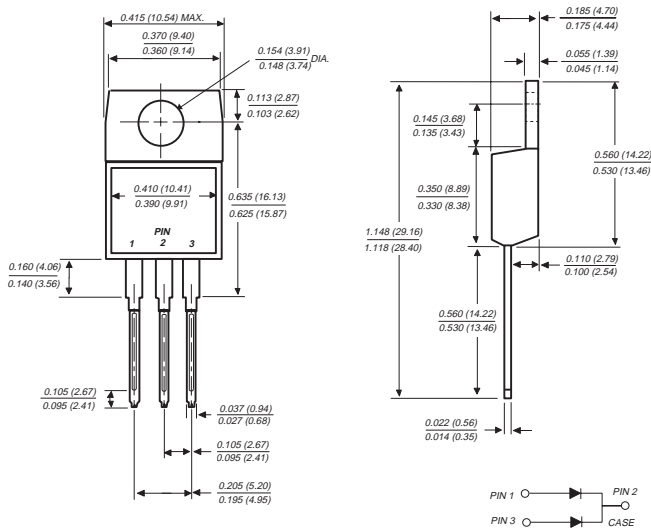

Dimensions in inches and (millimeters)

FEATURES

- ◆ Plastic package has Underwriters Laboratory Flammability Classifications 94V-0
- ◆ Metal silicon junction, majority carrier conduction
- ◆ Low power loss, high efficiency
- ◆ High current capability, low forward voltage drop
- ◆ High surge capacity
- ◆ For use in low voltage, high frequency inverters, free wheeling, and polarity protection applications
- ◆ Guardring for overvoltage protection
- ◆ High temperature soldering guaranteed: 250°C/10 seconds, 0.25" (6.35mm) from case

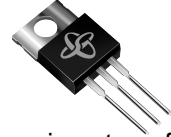

MECHANICAL DATA

Case: JEDEC TO-220AB molded plastic body
Terminals: Lead solderable per MIL-STD-750, Method 2026

Polarity: As marked

Mounting Position: Any

Mounting Torque: 5 in. - lbs max.

Weight: 0.08 ounce, 2.24 grams

MAXIMUM RATINGS AND ELECTRICAL CHARACTERISTICS

Ratings at 25°C ambient temperature unless otherwise specified.

	SYMBOLS	SBL1030CT	SBL1040CT	UNITS
Maximum repetitive peak reverse voltage	V_{RRM}	30	40	Volts
Maximum RMS voltage	V_{RMS}	21	28	Volts
Maximum DC blocking voltage	V_{DC}	30	40	Volts
Maximum average forward rectified current at $T_C=95^\circ\text{C}$	$I_{(AV)}$	10.0		Amps
Peak forward surge current, 8.3ms single half sine-wave superimposed on rated load (JEDEC Method)	I_{FSM}	175.0		Amps
Maximum instantaneous forward voltage per leg at 5.0A (NOTE 1)	V_F	0.55		Volts
Maximum instantaneous reverse current at rated DC blocking voltage (NOTE 1)	I_R	$T_C=25^\circ\text{C}$ $T_C=100^\circ\text{C}$	0.5 50.0	mA
Typical thermal resistance (NOTE 2)	$R_{\theta JC}$	3.0		$^\circ\text{C}/\text{W}$
Operating and storage temperature range	T_J, T_{STG}	-40 to +125		$^\circ\text{C}$

NOTES:

- (1) Pulse test: 300 μs pulse width, 1% duty cycle
- (2) Thermal resistance from junction to case per leg

RATINGS AND CHARACTERISTIC CURVES SBL1030CT AND SBL1040CT

FIG. 1 - FORWARD CURRENT DERATING CURVE

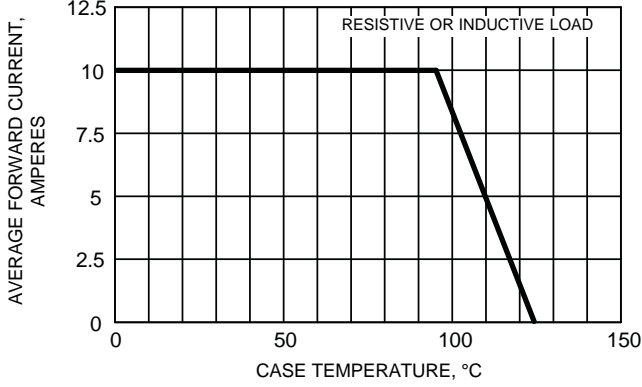

FIG. 2 - MAXIMUM NON-REPETITIVE PEAK FORWARD SURGE CURRENT

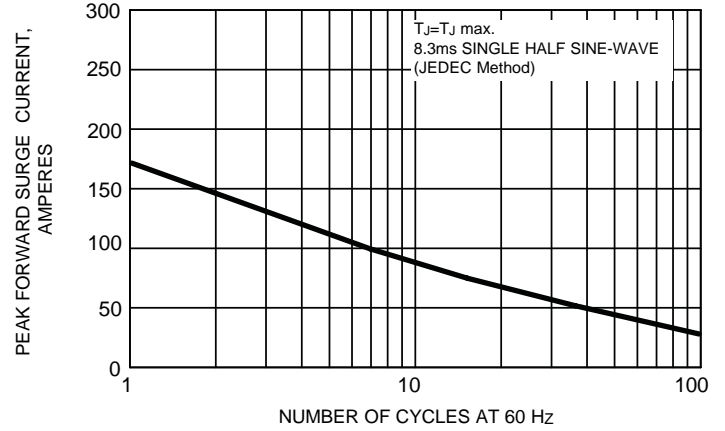

FIG. 3 - TYPICAL INSTANTANEOUS FORWARD CHARACTERISTICS PER LEG

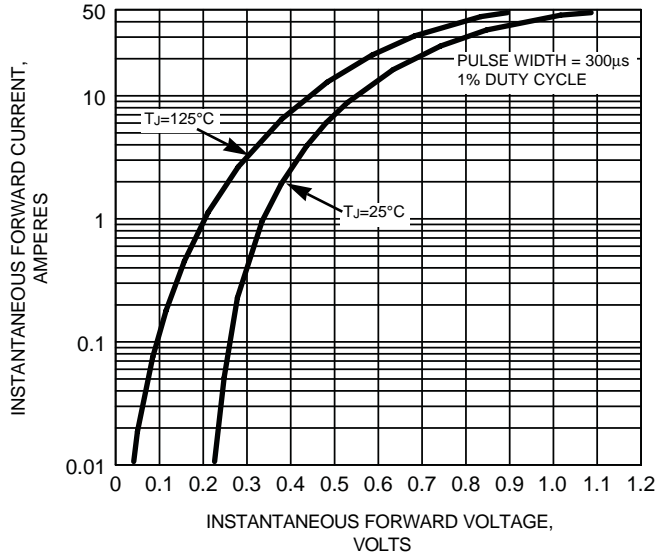

FIG. 4 - TYPICAL REVERSE CHARACTERISTICS PER LEG

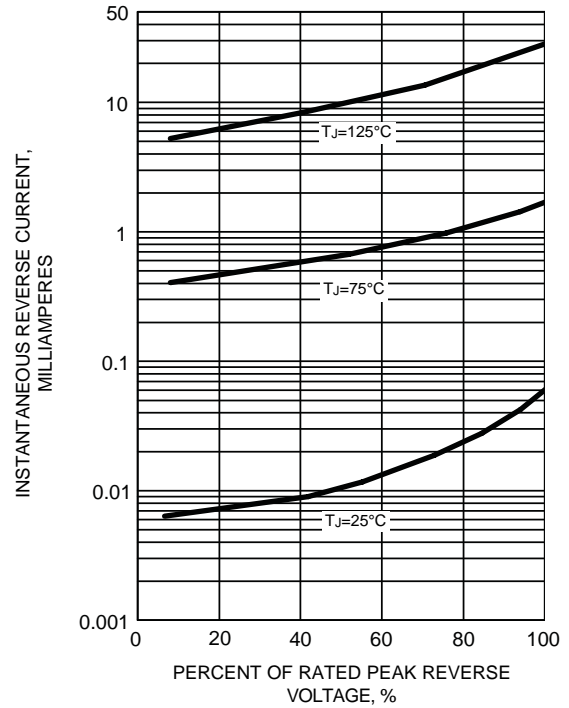

FIG. 5 - TYPICAL JUNCTION CAPACITANCE PER LEG

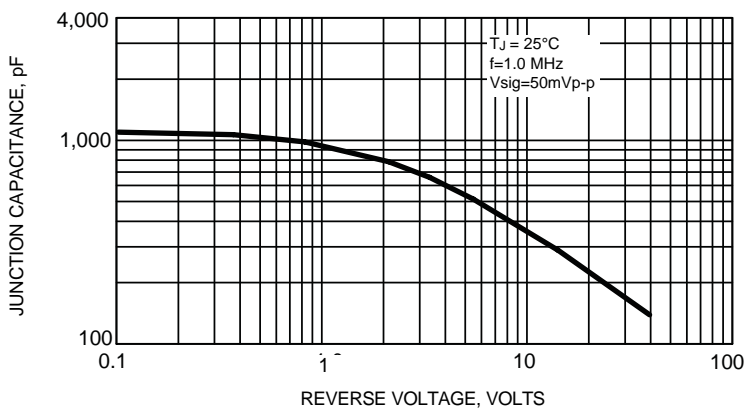

FIG. 6 - TYPICAL TRANSIENT THERMAL IMPEDANCE PER LEG

