

GENERAL SPECIFICATIONS FOR S301 ~ S339

Electrical Capacity (Resistive & Inductive Load)

Power Level: Shown in the following tables

Other Ratings

- Contact Resistance:** 10 milliohms maximum
- Insulation Resistance:** 1,000 megohms minimum @ 500V DC
- Dielectric Strength:** 2,000V AC minimum for 1 minute minimum
- Mechanical Life:** 50,000 operations minimum
- Electrical Life:** 6,000 operations minimum for S331F; 15,000 operations minimum for all other S331s; 25,000 operations minimum for all others
- Angle of Throw (α):** Shown on following tables

Materials & Finishes

- Toggle:** PBT for flatted lever; brass with chrome plating for all others
- Bushing:** Brass with chrome plating
- Case:** Melamine phenol
- Case Cover:** Steel with zinc plating
- Movable Contact:** Copper with silver plating
- Movable & Stationary Contacts:** Silver alloy capped on copper with silver plating
- Terminals:** Brass with silver plating















Installation

- Mounting Torque:** 2.94Nm (26 lb•in) for double nut; 1.47Nm (13 lb•in) for single nut
- Soldering Time & Temperature:** Manual Soldering: See Profile A in Supplement section.

Standards & Certifications

- UL Recognized:** Designated with UL recognized symbol beside part numbers on following pages
UL File No. WOYR2.E44145. Add "/U" to end of part number to order UL mark on switch.
- C-UL Recognized:** Designated with C-UL recognized symbol beside part numbers on following pages
C-UL File No. WOYR8.E44145. Add "/C-UL" to end of part number to order C-UL mark on switch.
- CSA Certified:** Designated with CSA certified symbol beside part numbers on following pages
File No. 023535-0-000. Add "/C" to end of part number to order CSA mark on switch.

SINGLE POLE WITH SOLDER LUG

Model	Approvals	Pole & Throw	Toggle Position/Connected Terminals () = Momentary						Electrical Capacity				Angle of Throw
			Down 	Center 	Up 	Resistive			Inductive				
						AC 125V	AC 250V	DC 30V	AC 125V PF 0.6				
S301	  	SPST	ON 1-3	NONE	OFF —	15A	6A	20A	10A	32°			
S302	  	SPDT	ON 2-3	NONE	ON 2-1	15A	6A	20A	10A	32°			
S303	  	SPDT	ON 2-3	OFF	ON 2-1	15A	6A	20A	10A	32°			
S305	— — 	SPDT	ON 2-3	NONE	(ON) 2-1	15A	6A	20A	8A	32°			
S308	— — 	SPDT	(ON) 2-3	OFF	(ON) 2-1	15A	6A	20A	8A	32°			
S309	— — 	SPDT	ON 2-3	OFF	(ON) 2-1	15A	6A	20A	8A	32°			

Throw & Schematics:

Note: Terminal numbers are actually on the switch

- Standard Hardware: AT503M Face Hex Nut, AT506 Locking Ring, AT508 Lockwasher, AT527M Backup Hex Nut. See Accessories & Hardware section.





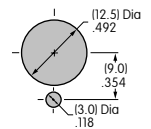
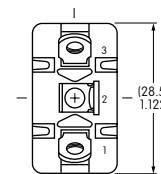
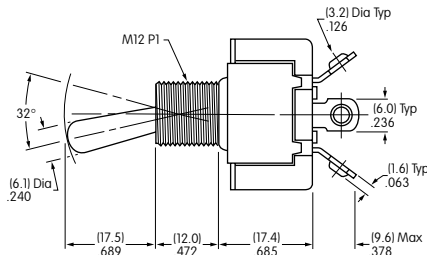
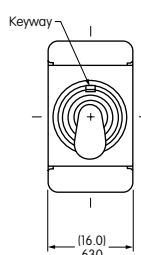















S301



Maximum Panel Thickness: .185" (4.7mm)

S301 does not have terminal 2

DOUBLE POLE WITH SOLDER LUG

Model	Approvals	Pole & Throw	Toggle Position/Connected Terminals () = Momentary			Electrical Capacity				α = Angle of Throw
			Down 	Center 	Up 	Resistive			Inductive	
						AC 125V	AC 250V	DC 30V	AC 125V PF 0.6	
S331	  	DPST	ON 1-3 4-6	NONE	OFF —	25A	25A	25A	10A	25°
S332	  	DPDT	ON 2-3 5-6	NONE	ON 2-1 5-4	25A	15A	25A	10A	25°
S333	  	DPDT	ON 2-3 5-6	OFF	ON 2-1 5-4	25A	15A	25A	10A	30°
S335	  	DPDT	ON 2-3 5-6	NONE	(ON) 2-1 5-4	15A	6A	20A	8A	25°
S338	  —	DPDT	(ON) 2-3 5-6	OFF	(ON) 2-1 5-4	15A	6A	20A	8A	25°
S339	  —	DPDT	ON 2-3 5-6	OFF	(ON) 2-1 5-4	15A	6A	20A	8A	25°

Throw & Schematics:



Note: Terminal numbers are actually on the switch

• Standard Hardware: AT503M Face Hex Nut, AT506 Locking Ring, AT508 Lockwasher, AT527M Backup Hex Nut. See Accessories & Hardware section.





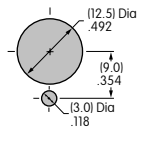
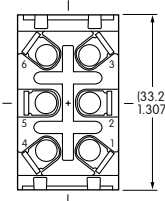
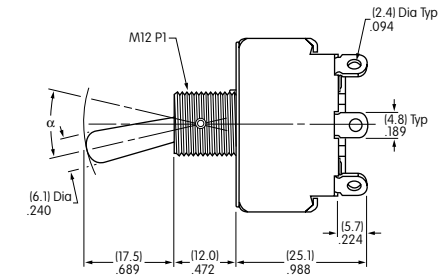
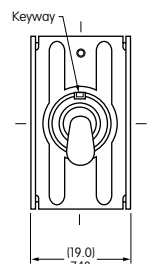









S331



S331 does not have terminals 2 & 5

Maximum Panel Thickness: .185" (4.7mm)

DOUBLE POLE WITH SOLDER LUG & FLATTED LEVER

Model	Approvals	Pole & Throw	Toggle Position/Connected Terminals () = Momentary			Electrical Capacity				α = Angle of Throw
			Down 	Center 	Up 	Resistive			Inductive	
						AC 125V	AC 250V	DC 30V	AC 125V PF 0.6	
S331R	  —	DPST	ON 1-3 4-6	NONE	OFF —	25A	25A	25A	10A	25°
S332R	  —	DPDT	ON 2-3 5-6	NONE	ON 2-1 5-4	25A	15A	25A	10A	25°
S333R	  —	DPDT	ON 2-3 5-6	OFF	ON 2-1 5-4	25A	15A	25A	10A	30°
S338R	  —	DPDT	(ON) 2-3 5-6	OFF	(ON) 2-1 5-4	15A	6A	20A	8A	25°
S339R	  —	DPDT	ON 2-3 5-6	OFF	(ON) 2-1 5-4	15A	6A	20A	8A	25°

Throw & Schematics:



Note: Terminal numbers are actually on the switch

• Standard Hardware: AT504M Knurled Nut, AT508 Lockwasher, AT527M Backup Hex Nut. See Accessories & Hardware section.





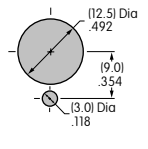
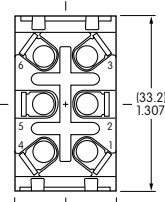
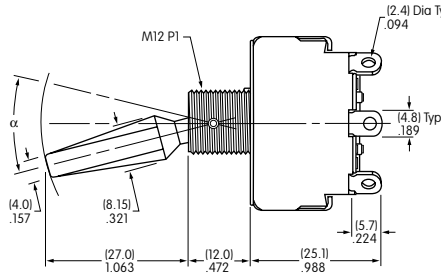
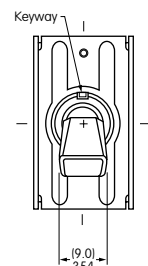











S331R



S331R does not have terminals 2 & 5

Maximum Panel Thickness: .220" (5.6mm)

SINGLE POLE WITH SCREW LUG

Model	Approvals	Pole & Throw	Toggle Position/Connected Terminals () = Momentary						Electrical Capacity				α = Angle of Throw
			Down 	Center 	Up 	Resistive			Inductive				
						AC 125V	AC 250V	DC 30V	AC 125V PF 0.6				
S301T	  	SPST	ON 1-3	NONE	OFF —	15A	6A	20A	10A	32°			
S302T	  	SPDT	ON 2-3	NONE	ON 2-1	15A	6A	20A	10A	32°			
S303T	  	SPDT	ON 2-3	OFF	ON 2-1	15A	6A	20A	10A	32°			
S305T	— — 	SPDT	ON 2-3	NONE	(ON) 2-1	15A	6A	20A	8A	32°			
S308T	— — 	SPDT	(ON) 2-3	OFF	(ON) 2-1	15A	6A	20A	8A	32°			
S309T	— — 	SPDT	ON 2-3	OFF	(ON) 2-1	15A	6A	20A	8A	32°			

Throw & Schematics:



Note: Terminal numbers are actually on the switch

- Standard Hardware: AT503M Face Hex Nut, AT506 Locking Ring, AT508 Lockwasher, AT527M Backup Hex Nut. See Accessories & Hardware section.





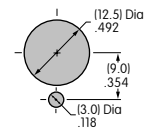
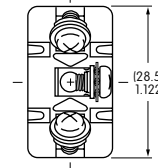
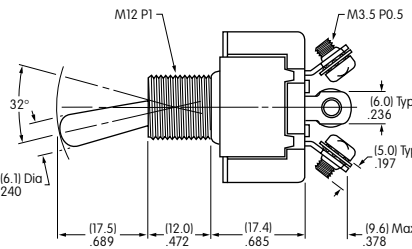
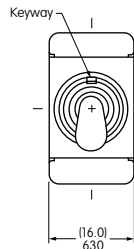











S301T



Maximum Panel Thickness: .185" (4.7mm)

S301T does not have terminal 2

DOUBLE POLE WITH SCREW LUG

Model	Approvals	Pole & Throw	Toggle Position/Connected Terminals () = Momentary						Electrical Capacity				α = Angle of Throw
			Down 	Center 	Up 	Resistive			Inductive				
						AC 125V	AC 250V	DC 30V	AC 125V PF 0.6				
S331T	  —	DPST	ON 1-3 4-6	NONE	OFF —	15A	15A	15A	10A	25°			
S332T	  —	DPDT	ON 2-3 5-6	NONE	ON 2-1 5-4	15A	15A	15A	10A	25°			
S333T	  —	DPDT	ON 2-3 5-6	OFF	ON 2-1 5-4	15A	15A	15A	10A	30°			
S335T	  —	DPDT	ON 2-3 5-6	NONE	(ON) 2-1 5-4	15A	6A	20A	8A	25°			
S338T	  —	DPDT	(ON) 2-3 5-6	OFF	(ON) 2-1 5-4	15A	6A	20A	8A	25°			
S339T	  —	DPDT	ON 2-3 5-6	OFF	(ON) 2-1 5-4	15A	6A	20A	8A	25°			

Throw & Schematics:



Note: Terminal numbers are actually on the switch

- Standard Hardware: AT503M Face Hex Nut, AT506 Locking Ring, AT508 Lockwasher, AT527M Backup Hex Nut. See Accessories & Hardware section.





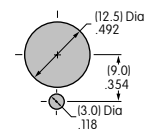
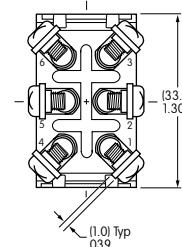
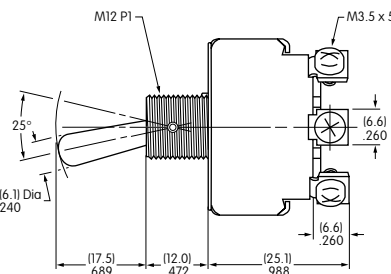
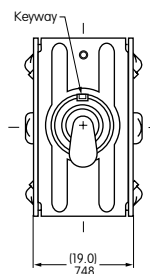



S331T



Maximum Panel Thickness: .185" (4.7mm)

S331T does not have terminals 2 & 5

SINGLE POLE WITH QUICK CONNECT

Model	Approvals	Pole & Throw	Toggle Position/Connected Terminals			Electrical Capacity				α = Angle of Throw
			Down 	Center 	Up 	Resistive			Inductive	
						AC 125V	AC 250V	DC 30V	AC 125V PF 0.6	
S301F	  	SPST	ON 1-3	NONE	OFF —	15A	6A	20A	10A	32°

Throw & Schematics: SPST 

Note: Terminal numbers are actually on the switch

• Standard Hardware: AT503M Face Hex Nut, AT506 Locking Ring, AT508 Lockwasher, AT527M Backup Hex Nut. See Accessories & Hardware section.





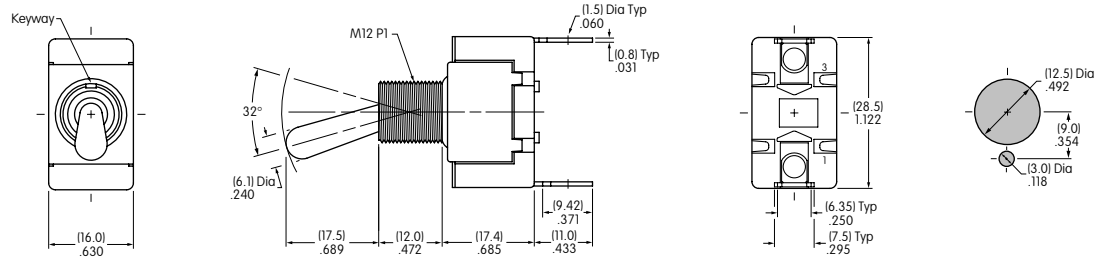







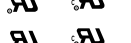

S301F

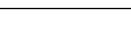

Maximum Panel Thickness: .185" (4.7mm)

DOUBLE POLE WITH QUICK CONNECT

Model	Approvals	Pole & Throw	Toggle Position/Connected Terminals () = Momentary			Electrical Capacity				α = Angle of Throw
			Down 	Center 	Up 	Resistive			Inductive	
						AC 125V	AC 250V	DC 30V	AC 125V PF 0.6	
S331F	  —	DPST	ON 1-3 4-6	NONE	OFF —	25A	25A	25A	10A	25°
S332F	  —	DPDT	ON 2-3 5-6	NONE	ON 2-1 5-4	25A	15A	25A	10A	25°
S333F	  —	DPDT	ON 2-3 5-6	OFF	ON 2-1 5-4	25A	15A	25A	10A	30°
S335F	  —	DPDT	ON 2-3 5-6	NONE	(ON) 2-1 5-4	15A	6A	20A	8A	25°

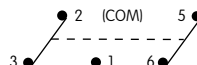
Throw & Schematics: DPST  INTERNAL CONNECTION DPDT 

Note: Terminal numbers are actually on the switch

• Standard Hardware: AT503M Face Hex Nut, AT506 Locking Ring, AT508 Lockwasher, AT527M Backup Hex Nut. See Accessories & Hardware section.



S332F

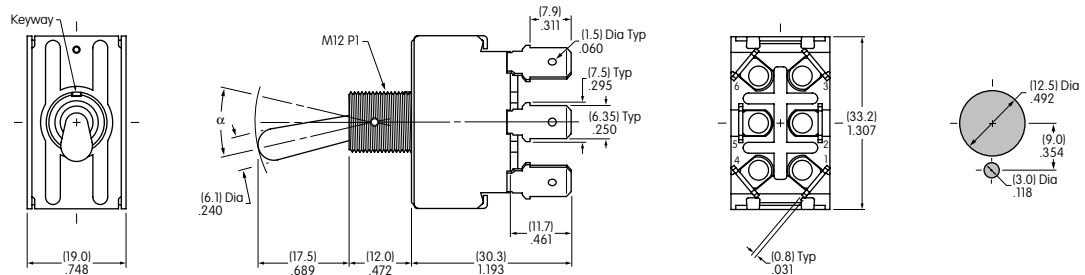

Maximum Panel Thickness: .185" (4.7mm)

S331F does not have terminals 2 & 5

GENERAL SPECIFICATIONS FOR S31 ~ S49

Electrical Capacity (Resistive & Inductive Load)

Power Level: Shown in the following tables

Other Ratings

- Contact Resistance:** 10 milliohms maximum
- Insulation Resistance:** 1,000 megohms minimum @ 500V DC
- Dielectric Strength:** 2,000V AC minimum for 1 minute minimum
- Mechanical Life:** 50,000 operations minimum
- Electrical Life:** 25,000 operations minimum
- Angle of Throw (α):** Shown on following tables

Materials & Finishes

- Toggle:** PBT resin for flatted lever; brass with chrome plating for all others
- Bushing:** Brass with chrome plating
- Case:** Phenolic resin
- Case Cover:** Steel with chromate plating over zinc plating
- Movable Contactor:** Copper with silver plating
- Movable Contacts:** Silver alloy capped on copper with silver plating
- Stationary Contacts:** Silver alloy capped on copper with silver plating
- Terminals:** Brass with silver plating

Environmental Data

Operating Temp Range: -10°C through +70°C (+14°F through +158°F)









Installation

- Mounting Torque:** 2.94Nm (26 lb•in) for double nut
- Maximum Panel Thickness:** Shown beneath panel cutout in switch dimension drawings
- Soldering Time & Temperature:** Manual Soldering: See Profile A in Supplement section.

Standards & Certifications

- UL Recognized:** Designated with UL recognized symbol beside part numbers on following pages. See Supplement section to find UL rating details. UL File No. WOYR2.E44145
Add "/U" to end of part number to order UL mark on switch.
- C-UL Recognized:** Designated with C-UL recognized symbol beside part numbers on following pages. See Supplement section to find C-UL rating details. C-UL File No. WOYR8.E44145
Add "/C-UL" to end of part number to order C-UL mark on switch.
- CSA Certified:** Designated with CSA certified symbol beside part numbers on following pages. See Supplement section to find CSA rating details. File No. 023535-0-000
Add "/C" to end of part number to order CSA mark on switch.

THREE POLE WITH SOLDER LUG

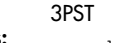

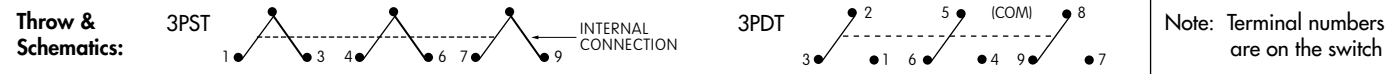

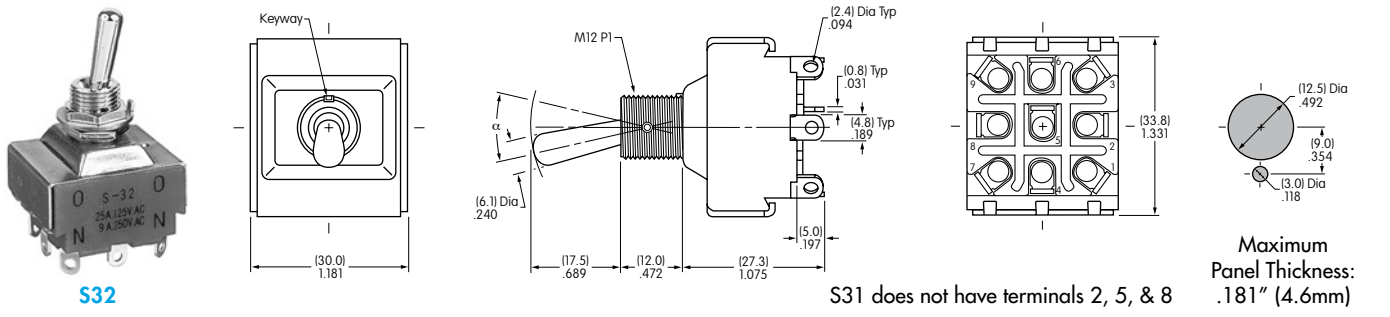

*See Supplement section for UL detail			Toggle Position/Connected Terminals () = Momentary						Electrical Capacity				α = Angle of Throw
Model	Approvals	Pole & Throw	Down 	Center 	Up 	Resistive			Inductive				
						AC 125V	AC 250V	DC 30V	AC 125V PF 0.6				
S31		3PST	ON 1-3 4-6 7-9	NONE	OFF —	25A	9A	20A	10A	25°			
S32		3PDT	ON 2-3 5-6 8-9	NONE	ON 2-1 5-4 8-7	25A	9A	20A	10A	25°			
S33		3PDT	ON 2-3 5-6 8-9	OFF	ON 2-1 5-4 8-7	25A	9A	20A	10A	30°			
S35		3PDT	ON 2-3 5-6 8-9	NONE	(ON) 2-1 5-4 8-7	15A	6A	20A	8A	25°			
S38		3PDT	(ON) 2-3 5-6 8-9	OFF	(ON) 2-1 5-4 8-7	15A	6A	15A	8A	25°			
S39		3PDT	ON 2-3 5-6 8-9	OFF	(ON) 2-1 5-4 8-7	15A	6A	15A	8A	25°			



• Standard Hardware: AT503M Face Hex Nut, AT506 Locking Ring, AT508 Lockwasher, AT527M Backup Hex Nut. See Accessories & Hardware section.

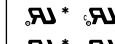

FOUR POLE WITH SOLDER LUG

*See Supplement section for UL detail			Toggle Position/Connected Terminals () = Momentary						Electrical Capacity				α = Angle of Throw
Model Suffix R = Flatted Lever	Approvals	Pole & Throw	Down 	Center 	Up 	Resistive			Inductive				
						AC 125V	AC 250V	DC 30V	AC 125V PF 0.6				
S41/S41R		4PST	ON 1-3 4-6 7-9 10-12	NONE	OFF —	25A	9A	20A	10A	25°			
S42/S42R		4PDT	ON 2-3 5-6 8-9 11-12	NONE	ON 2-1 5-4 8-7 11-10	25A	9A	20A	10A	25°			
S43/S43R		4PDT	ON 2-3 5-6 8-9 11-12	OFF	ON 2-1 5-4 8-7 11-10	25A	9A	20A	10A	30°			
S45	—	4PDT	ON 2-3 5-6 8-9 11-12	NONE	(ON) 2-1 5-4 8-7 11-10	15A	6A	20A	8A	25°			
S48/S48R		4PDT	(ON) 2-3 5-6 8-9 11-12	OFF	(ON) 2-1 5-4 8-7 11-10	15A	6A	20A	8A	25°			
S49/S49R		4PDT	ON 2-3 5-6 8-9 11-12	OFF	(ON) 2-1 5-4 8-7 11-10	15A	6A	20A	8A	25°			





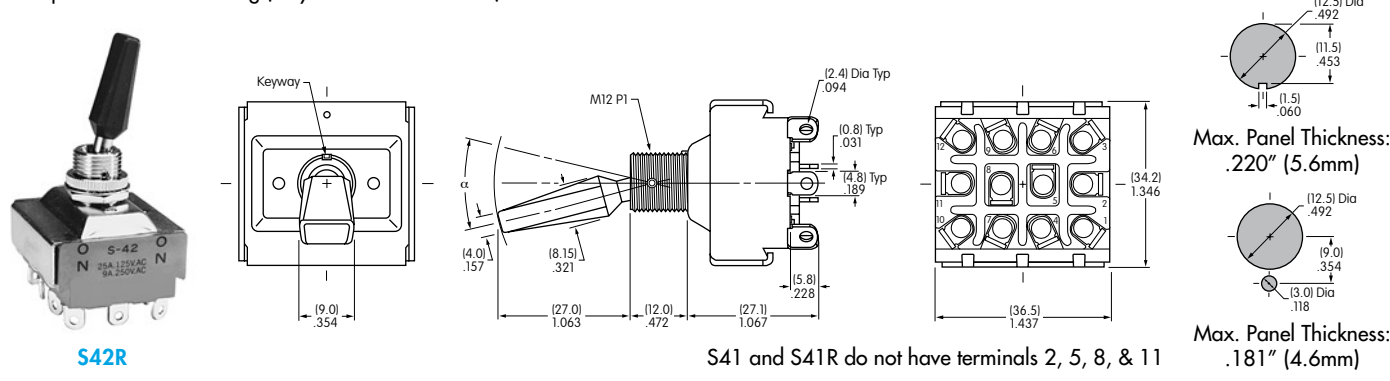





• Standard Hardware for **Bat Lever**: AT503M Face Hex Nut, AT506 Locking Ring, AT508 Lockwasher, AT527M Backup Hex Nut; for **Flatted Lever (R)**: AT504M Knurled Face Nut, AT508 Lockwasher, AT527M Backup Hex Nut. See Accessories & Hardware section. • Optional Splashproof Boot Assembly: AT4181 boot plus hex nut and o-ring (only for bat lever models). See Accessories & Hardware section.



THREE POLE WITH SCREW LUG

*See Supplement section for CSA detail

Model	Approvals	Pole & Throw	Toggle Position/Connected Terminals			Electrical Capacity					α = Angle of Throw
			Down 	Center 	Up 	Resistive			Inductive		
						AC 125V	AC 250V	DC 30V	AC 125V PF 0.6	AC 250V PF 0.6	
S31T	—   *	3PST	ON 1-3 4-6 7-9	NONE	OFF —	25A	9A	20A	10A	5A	25°
S32T	—   *	3PDT	ON 2-3 5-6 8-9	NONE	ON 2-1 5-4 8-7	25A	9A	20A	10A	5A	25°
S33T	—   *	3PDT	ON 2-3 5-6 8-9	OFF	ON 2-1 5-4 8-7	25A	9A	20A	10A	5A	30°

Throw & Schematics:

3PST:  INTERNAL CONNECTION

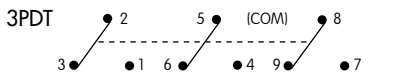
3PDT:  (COM) 8

Note: Terminal numbers are on the switch

• Standard Hardware: AT503M Face Hex Nut, AT506 Locking Ring, AT508 Lockwasher, AT527M Backup Hex Nut. See Accessories & Hardware section.



S32T

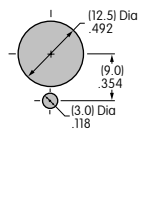
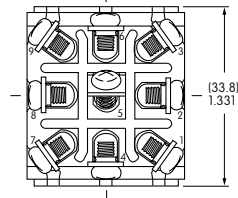
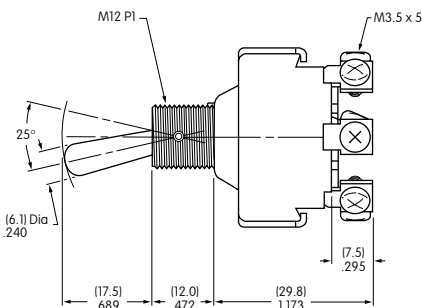
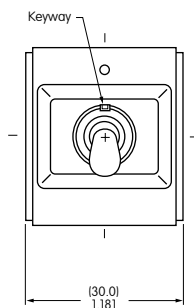







Maximum Panel Thickness: .181" (4.6mm)

S31T does not have terminals 2, 5, & 8

FOUR POLE WITH SCREW LUG

*See Supplement section for CSA detail

Model	Approvals	Pole & Throw	Toggle Position/Connected Terminals			Electrical Capacity					α = Angle of Throw
			Down 	Center 	Up 	Resistive			Inductive		
						AC 125V	AC 250V	DC 30V	AC 125V PF 0.6	AC 250V PF 0.6	
S41T	—  *	4PST	ON 1-3 4-6 7-9 10-12	NONE	OFF —	25A	9A	20A	10A	5A	25°
S42T	—  *	4PDT	ON 2-3 5-6 8-9 11-12	NONE	ON 2-1 5-4 8-7 11-10	25A	9A	20A	10A	5A	25°
S43T	—  *	4PDT	ON 2-3 5-6 8-9 11-12	OFF	ON 2-1 5-4 8-7 11-10	25A	9A	20A	10A	5A	30°

Throw & Schematics:

4PST:  INTERNAL CONNECTION

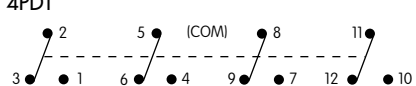
4PDT:  (COM) 8

Note: Terminal numbers are on the switch

• Standard Hardware: AT503M Face Hex Nut, AT506 Locking Ring, AT508 Lockwasher, AT527M Backup Hex Nut. See Accessories & Hardware section.





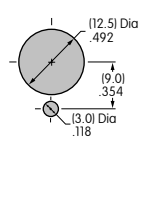
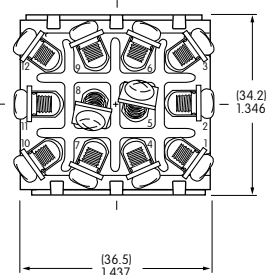
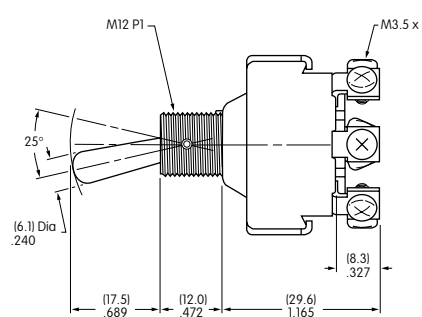
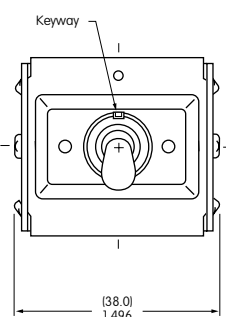



S42T



Maximum Panel Thickness: .181" (4.6mm)

S41T does not have terminals 2, 5, 8, & 11

THREE POLE WITH QUICK CONNECT

*See Supplement section for UL detail			Toggle Position/Connected Terminals					Electrical Capacity				$\alpha =$ Angle of Throw
Model	Approvals	Pole & Throw	Down	Center	Up	Resistive			Inductive			
						AC 125V	AC 250V	DC 30V	AC 125V PF 0.6			
S31F		3PST	ON 1-3 4-6 7-9	NONE	OFF	—	25A	9A	20A	10A	25°	
S32F		3PDT	ON 2-3 5-6 8-9	NONE	ON 2-1 5-4 8-7	—	25A	9A	20A	10A	25°	
S33F		3PDT	ON 2-3 5-6 8-9	OFF	ON 2-1 5-4 8-7	—	25A	9A	20A	10A	30°	

Throw & Schematics:



Note: Terminal numbers are on the switch

- Standard Hardware: AT503M Face Hex Nut, AT506 Locking Ring, AT508 Lockwasher, AT527M Backup Hex Nut. See Accessories & Hardware section.





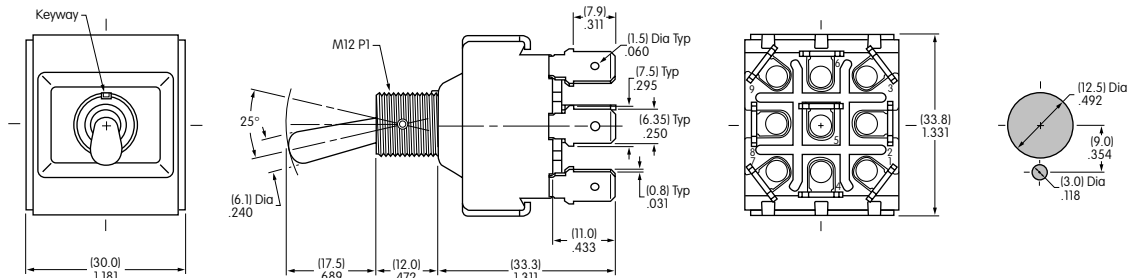



S32F



S31F does not have terminals 2, 5, & 8

Maximum Panel Thickness: .181" (4.6mm)

FOUR POLE WITH QUICK CONNECT

*See Supplement section for UL detail			Toggle Position/Connected Terminals					Electrical Capacity				$\alpha =$ Angle of Throw
Model	Approvals	Pole & Throw	Down	Center	Up	Resistive			Inductive			
						AC 125V	AC 250V	DC 30V	AC 125V PF 0.6			
S41F		4PST	ON 1-3 4-6 7-9 10-12	NONE	OFF	—	25A	9A	20A	10A	25°	
S42F		4PDT	ON 2-3 5-6 8-9 11-12	NONE	ON 2-1 5-4 8-7 11-10	—	25A	9A	20A	10A	25°	
S43F		4PDT	ON 2-3 5-6 8-9 11-12	OFF	ON 2-1 5-4 8-7 11-10	—	25A	9A	20A	10A	30°	

Throw & Schematics:



Note: Terminal numbers are on the switch

- Standard Hardware: AT503M Face Hex Nut, AT506 Locking Ring, AT508 Lockwasher, AT527M Backup Hex Nut. See Accessories & Hardware section.



S42F

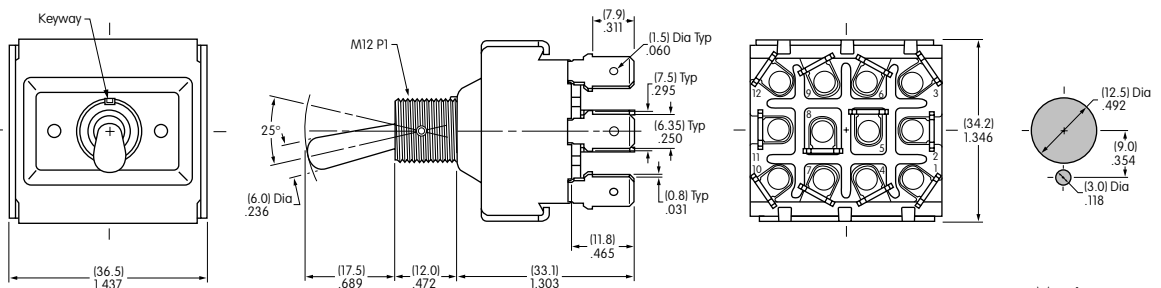

S41F does not have terminals 2, 5, 8, & 11

Maximum Panel Thickness: .181" (4.6mm)

GENERAL SPECIFICATIONS FOR S421 ~ S429

Electrical Capacity (Resistive & Inductive Load)

Power Level: Shown in the following tables

Other Ratings

- Contact Resistance:** 10 milliohms maximum
- Insulation Resistance:** 1,000 megohms minimum @ 500V DC
- Dielectric Strength:** 2,000V AC minimum for 1 minute minimum
- Mechanical Life:** 50,000 operations minimum for all other models
- Electrical Life:** 15,000 operations minimum
- Angle of Throw (α):** Shown in tables on following pages

Materials & Finishes

- Toggle:** Brass with chrome plating
- Bushing:** Brass with chrome plating
- Case:** Melamine phenol
- Case Cover:** Steel with chromate plating over zinc plating
- Movable Contactor:** Copper with silver plating
- Movable Contacts:** Silver alloy capped on copper with silver plating
- Stationary Contacts:** Silver alloy capped on copper with silver plating
- Terminals:** Brass with silver plating



Environmental Data

Operating Temp Range: -10°C through +70°C (+14°F through +158°F)

Installation

- Mounting Torque:** 2.94Nm (26 lb•in) for double nut
- Maximum Panel Thickness:** Shown beneath panel cutout in switch dimension drawings
- Soldering Time & Temperature:** Manual Soldering: See Profile A in Supplement section.

DOUBLE POLE WITH SOLDER LUG

Model	Approvals	Pole & Throw	Toggle Position/Connected Terminals () = Momentary					Electrical Capacity				Motor Load AC 125V	α = Angle of Throw
			Down 	Center 	Up 	Resistive		Inductive					
						AC 125V	AC 250V	PF 0.75 - 0.8					
S421	— —	DPST	ON 1-3 4-6	NONE	OFF —	25A	25A	25A	25A	750W	24°		
S422	— —	DPDT	ON 2-3 5-6	NONE	ON 2-1 5-4	25A	25A	25A	25A	750W	24°		
S423	— —	DPDT	ON 2-3 5-6	OFF	ON 2-1 5-4	25A	25A	25A	25A	750W	28°		
S425	— —	DPDT	ON 2-3 5-6	NONE	(ON) 2-1 5-4	15A	15A	15A	15A	400W	24°		
S428	— —	DPDT	(ON) 2-3 5-6	OFF	(ON) 2-1 5-4	15A	15A	15A	15A	400W	24°		
S429	— —	DPDT	ON 2-3 5-6	OFF	(ON) 2-1 5-4	15A	15A	15A	15A	400W	24°		

Throw & Schematics:



Note: Terminal numbers are on the switch

- Standard Hardware: AT503M Face Hex Nut, AT506 Locking Ring, AT508 Lockwasher, AT527M Backup Hex Nut. See Accessories & Hardware section.



S422

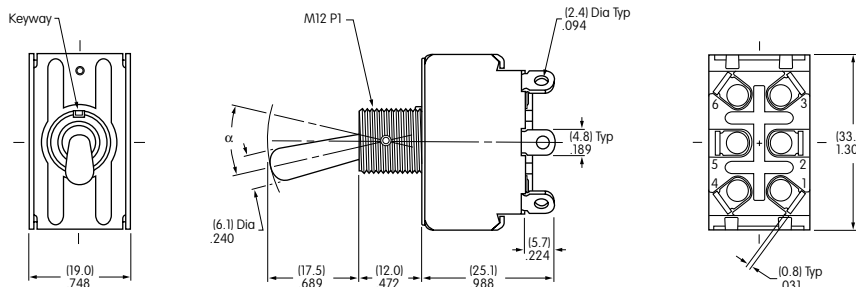

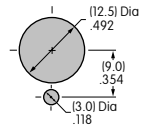

S421 does not have terminals 2 & 5



Maximum Panel Thickness: .185" (4.7mm)

DOUBLE POLE WITH SCREW LUG

Model	Approvals	Pole & Throw	Toggle Position/Connected Terminals () = Momentary					Electrical Capacity				Motor Load AC 125V	α = Angle of Throw
			Down 	Center 	Up 	Resistive		Inductive					
						AC 125V	AC 250V	PF 0.75 - 0.8					
S421T	— —	DPST	ON 1-3 4-6	NONE	OFF —	20A	20A	20A	20A	750W	24°		
S422T	— —	DPDT	ON 2-3 5-6	NONE	ON 2-1 5-4	20A	20A	20A	20A	750W	24°		
S423T	— —	DPDT	ON 2-3 5-6	OFF	ON 2-1 5-4	20A	20A	20A	20A	750W	28°		
S425T	— —	DPDT	ON 2-3 5-6	NONE	(ON) 2-1 5-4	15A	15A	15A	15A	400W	24°		
S428T	— —	DPDT	(ON) 2-3 5-6	OFF	(ON) 2-1 5-4	15A	15A	15A	15A	400W	24°		
S429T	— —	DPDT	ON 2-3 5-6	OFF	(ON) 2-1 5-4	15A	15A	15A	15A	400W	24°		

Throw & Schematics:



Note: Terminal numbers are on the switch

- Standard Hardware: AT503M Face Hex Nut, AT506 Locking Ring, AT508 Lockwasher, AT527M Backup Hex Nut. See Accessories & Hardware section.



S423T

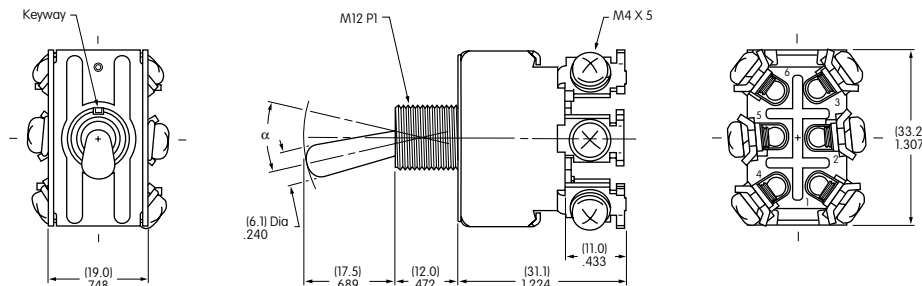

S421T does not have terminals 2 & 5

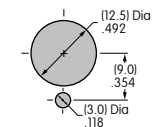

Maximum Panel Thickness: .185" (4.7mm)