

# 150mA LDO Regulator with POG

## General Description

The RT9181 is a low dropout voltage regulator with an output 2% accuracy and supply a continuous 150mA current within operating range from a +3V to +5.5V input. The power good function monitors the output voltage and indicates by pulling low the power good output (open drain).

The RT9181 requires a small output capacitor with low ESR for stabilizing output voltage. The device also minimizes output overshoot during power up.

The RT9181 uses an internal PMOS as the pass device, which consumes 160µA supply current independent of load and dropout conditions. The CE pin controls the output and consumes no input bias current. Other features include current limiting, over temperature protection, and under voltage lockout.

## Applications

- Processor Power-Up Sequencing
- Laptop, Notebook, and Palmtop Computers

## Ordering Information

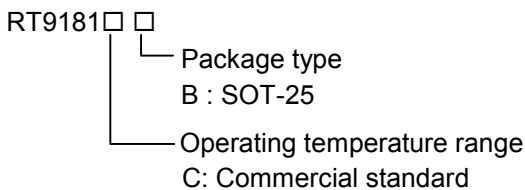

## Features

- Low Dropout Voltage Regulator, Output 1.2V
- Up to 150mA Output Current
- Power Good (POG) Function
- Chip Enable/Shutdown Function
- Load Independent, Low Ground Current, 160µA
- Current Limiting and Thermal Protection
- Under Voltage Lockout (UVLO)
- Low Variation Due to Load and Line Regulation
- Output Stable with Low ESR Capacitors
- SOT-25 Package

## Pin Configurations

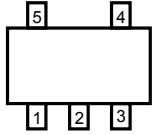
Part Number	Pin Configurations
RT9181CB (Plastic SOT-25)	<p>TOP VIEW</p>  <p>1. VIN 2. GND 3. CE 4. POG 5. VOUT</p>

## Typical Application Circuit

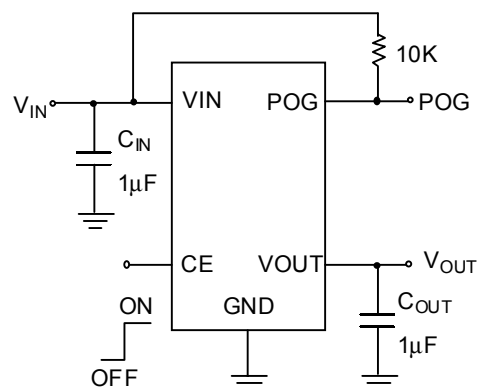

**Pin Description**

Pin Name	Pin Function
VIN	Input Pin
GND	Power Ground Pin
CE	Enable/Shutdown Input (Active High)
POG	Power Good Indicator
VOUT	Output Pin

**Function Block Diagram**

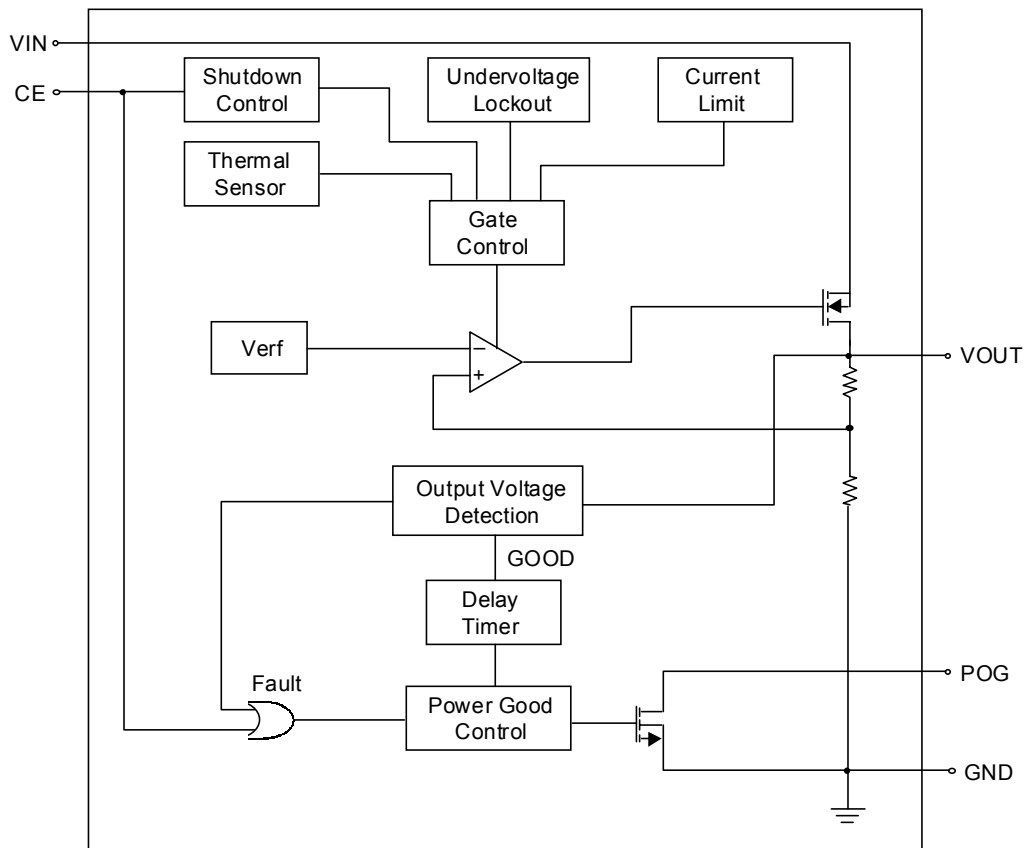

**Absolute Maximum Ratings**

- Input Voltage,  $V_{IN}$  ..... 7V
- CE Input Voltage ..... 7V
- Power Good Output Voltage ..... 7V
- Power Dissipation,  $P_D$  @  $T_A = 25^\circ C$   
SOT-25 ..... 570mW
- Junction Temperature Range .....  $-40^\circ C \sim 125^\circ C$
- Storage Temperature Range .....  $-65^\circ C \sim 150^\circ C$
- Operating Temperature Range .....  $0^\circ C \sim 70^\circ C$
- Lead Temperature (Soldering, 10 sec.) .....  $260^\circ C$

**Electrical Characteristics**

( $V_{IN} = 5V$ ,  $C_{IN} = C_{OUT} = 1\mu F$ ,  $T_A = 25^\circ C$ , unless otherwise specified)

Parameter	Symbol	Test Conditions	Min	Typ	Max	Units
Input Voltage Range	$V_{IN}$		3	--	5.5	V
Output Voltage Accuracy	$\Delta V_{OUT}$	$I_L = 25mA$	1.182	1.2	1.218	%
		$I_L = 0.1mA$ , $T_A = 0^\circ C$ to $70^\circ C$ (Note)	-2	--	+2	
Output Load Current		Continuous	150	--	--	mA
Current Limit	$I_{LIMIT}$	$R_{LOAD} = 1\Omega$	160	300	--	mA
GND Current	$I_G$	No Load	90	160	250	$\mu A$
Line Regulation	$\Delta V_{LINE}$	$V_{IN} = 3$ to $5.5V$ , $I_{OUT} = 0.1mA$	-0.3	--	+0.3	%
Load Regulation	$\Delta V_{LOAD}$	$I_L = 0.1mA$ to $150mA$	--	--	+3	%
Dropout Voltage	$V_{DROP}$	$I_L = 150mA$	--	1	--	V
CE Input High Threshold		$V_{IN} = 3$ to $5.5V$	2	--	--	V
CE Input Low Threshold		$V_{IN} = 3$ to $5.5V$	--	--	0.8	V
CE Input Bias Current		CE = GND or $V_{IN}$	--	--	100	nA
CE Supply Current		CE = GND	--	0.01	--	$\mu A$
$V_{POGH}$ Power Good Low Threshold		Output falls % of $V_{OUT}$ (power NOT timer (Power good))	85	--	--	%
$V_{POGH}$ Power Good High Threshold		Output reaches % of $V_{OUT}$ , start delay timer (power good)	--	--	90	%
$V_{OL}$ Power Good Output Logic Low		Fault condition, $I_{OL} = 100\mu A$	--	--	0.4	V
$t_{d(POG)}$ Delay Time to Power Good		See timing diagram	1	2	5	mS
Power Up Overshoot		Maximum voltage overshoot allowed on output during power-up	--	1	--	%
Thermal Shutdown Temperature	$T_{SD}$		--	150	--	$^\circ C$
Thermal Shutdown Hysteresis			--	20	--	$^\circ C$
Output Voltage AC PSRR		100Hz, $C_{OUT} = 1\mu F$ , $R_{LOAD} = 100\Omega$	--	62	--	dB

Note: Assured by design, not tested in production

Typical Operating Characteristics

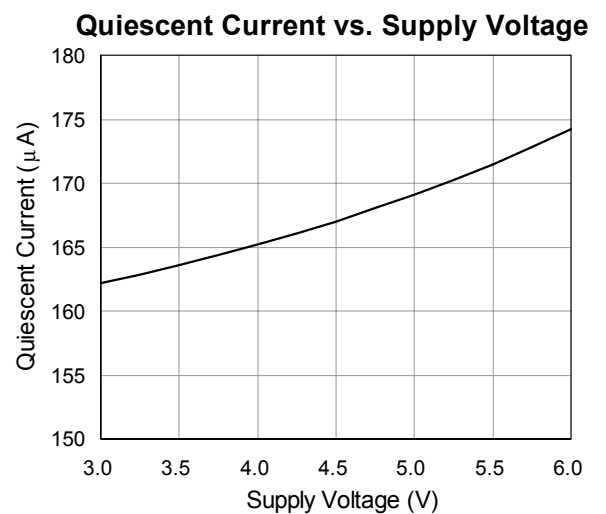
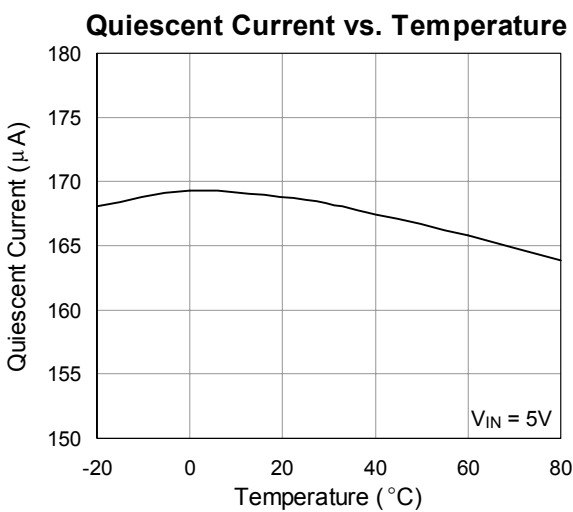
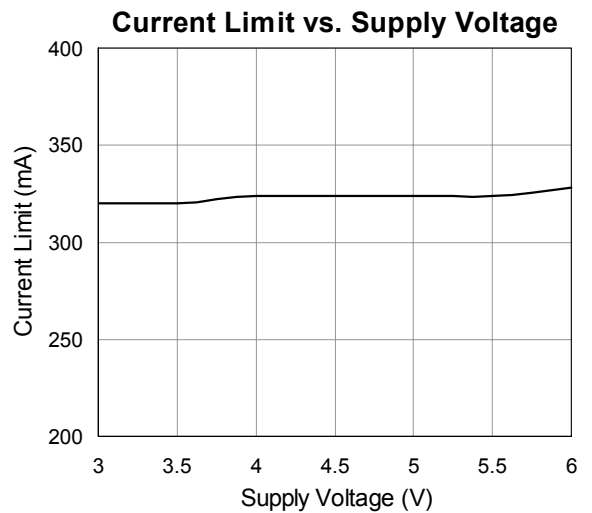
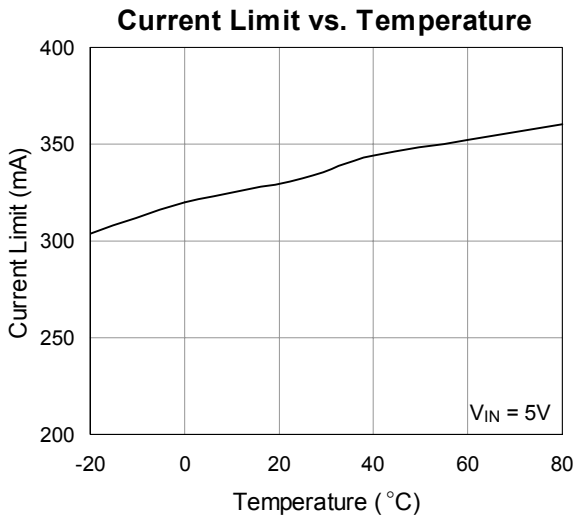
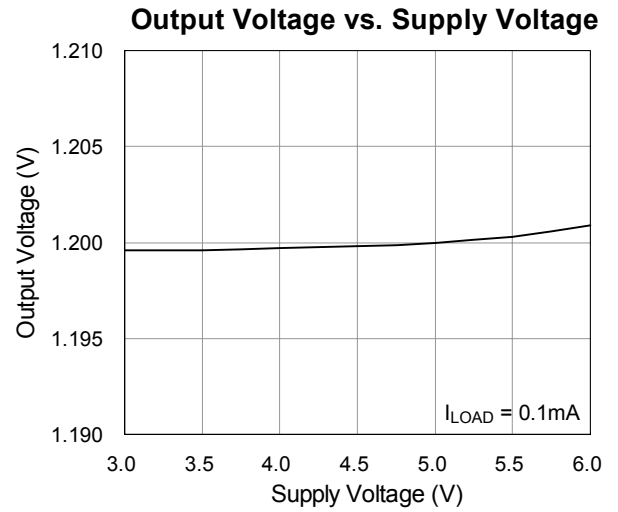
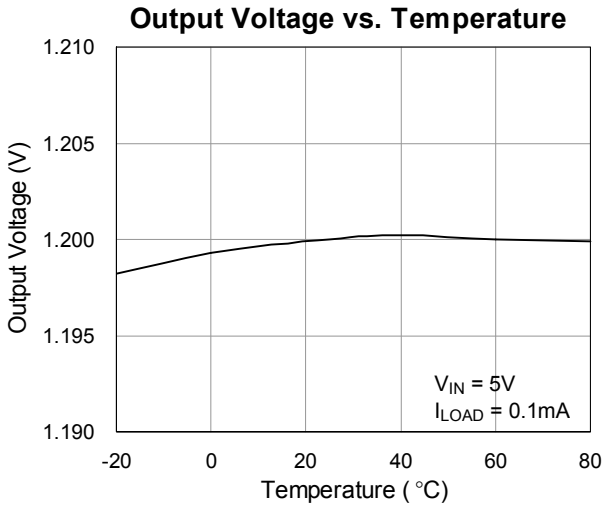

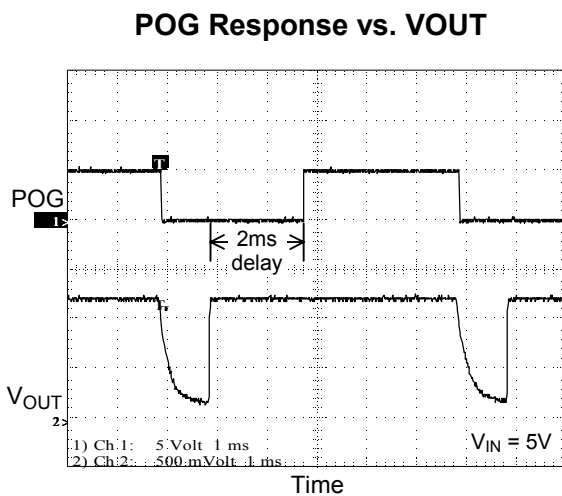
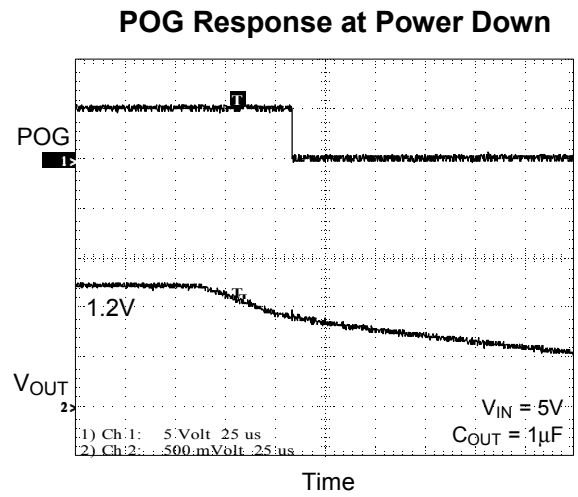
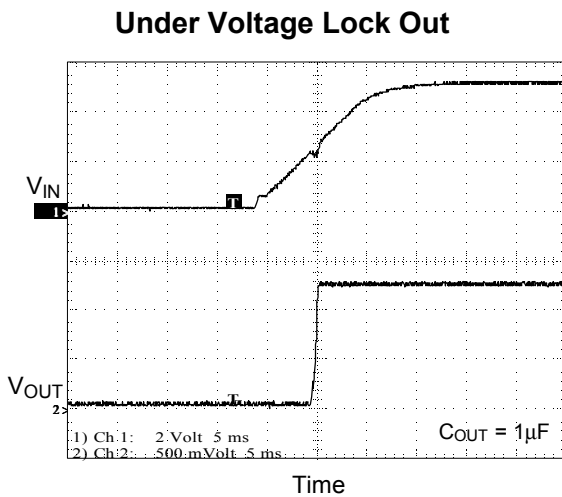
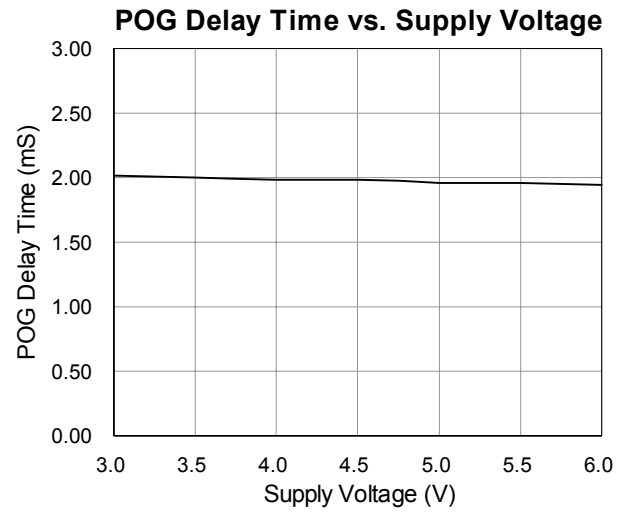
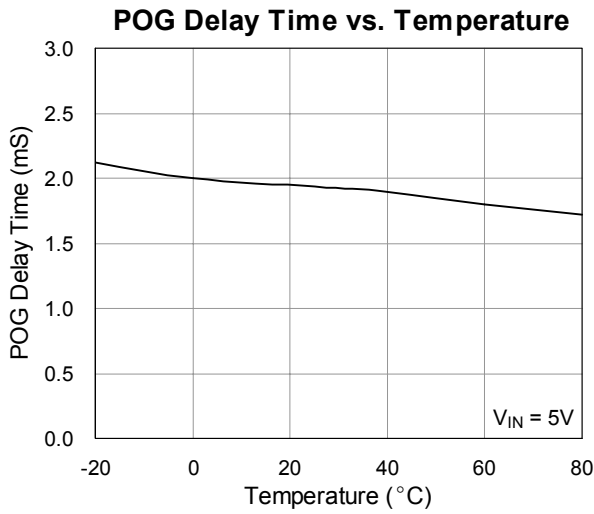

## Timing Diagram

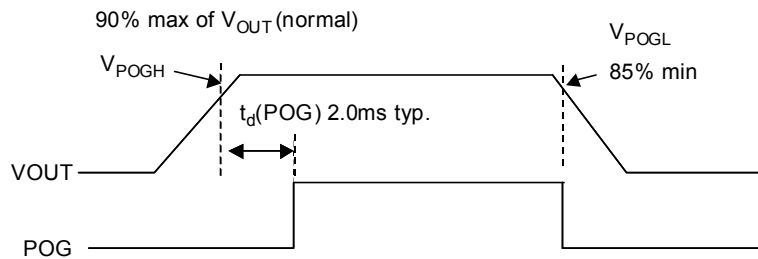

## Application Guides

### CE/Shutdown

The RT9181 is enabled by driving the CE input high, and shutdown by pulling the input low. If this feature is not to be used, the CE input should be tied to VIN to keep the regulator enabled at all times (the CE input must **not** be left floating).

### Internal P-Channel Pass Transistor

The RT9181 features a P-channel MOSFET pass transistors. It provides several advantages over similar designs using PNP pass transistors, including longer battery life. The P-channel MOSFET requires no base drive, which reduces quiescent current considerably. PNP-based regulators waste considerable current in dropout when the pass transistor saturates. They also use high base-drive currents under large loads. The RT9181 does not suffer from these problems and consume only 160μA of quiescent current whether in dropout, light-load, or heavy-load applications.

### Power Good

The power good output is an open-drain output. It is designed essentially to work as a power-on reset generator once the regulated voltage was up or a fault condition. The output of the power good drives low when a fault condition occurs. The power good output come back up once the output has reached 90% of its nominal value and a 2.0ms (typ.) delay has passed. See Timing Diagram. The output voltage level will be drooped at the fault conditions including current limit, thermal shutdown, or shutdown and triggers the POG detector to alarm a fault condition. This output is fed into an on-board delay circuitry that

drives the open drain transistor to indicate a fault. Because at shutdown mode, a fault condition occurs by pulling the POG output low, it will sink a current from the open drain and the external power. Selecting a suitable pulling resistance will be well to control this dissipated power.

### Current Limit and Thermal Protection

The RT9181 includes a current limit structure which monitor and control the pass transistor's gate voltage limiting the guaranteed maximum output current to 150mA minimum.

Thermal-overload protection limits total power dissipation in the RT9181. When the junction temperature exceeds  $T_J = +150^{\circ}\text{C}$ , the thermal sensor signals the shutdown logic turning off the pass transistor and allowing the IC to cool. The thermal sensor will turn the pass transistor on again after the IC's junction temperature cools by  $20^{\circ}\text{C}$ , resulting in a pulsed output during continuous thermal-overload conditions. Thermal-overloaded protection is designed to protect the RT9181 in the event of fault conditions. Do not exceed the absolute maximum junction-temperature rating of  $T_J = +125^{\circ}\text{C}$  for continuous operation. The output can be shorted to ground for and indefinite amount of time without damaging the part by cooperation of current limit and thermal protection.

### Operating Region and Power Dissipation

The maximum power dissipation of RT9181 depends on the thermal resistance of the case and circuit board, the temperature difference between the die junction and ambient air, and the rate of air flow. The

power dissipation across the device is

$$P = I_{OUT} (V_{IN} - V_{OUT})$$

The GND pin of the RT9181 performs the dual function of providing an electrical connection to ground and channeling heat away. Connect the GND pin to ground using a large pad or ground plane.

**Capacitor Selection and Regulator Stability**

Like any low-dropout regulator, the external capacitors used with the RT9181 must be carefully selected for regulator stability and performance.

Using a capacitor whose value is  $\geq 1\mu\text{F}$  on the RT9181 input and the amount of capacitance can be increased without limit. The input capacitor must be located a distance of not more than 0.5" from the input pin of the IC and returned to a clean analog ground. Any good quality ceramic or tantalum can be used for this capacitor. The capacitor with larger value and lower ESR (equivalent series resistance) provides better PSRR and line-transient response.

The output capacitor must meet both requirements for minimum amount of capacitance and ESR in all LDO applications. The RT9181 is designed specifically to work with low ESR ceramic output capacitor in space-saving and performance consideration. Using a ceramic capacitor whose value is at least  $1\mu\text{F}$  with ESR is  $> 5\text{m}\Omega$  on the RT9181 output ensures stability. The RT9181 still works well with output capacitor of other types due to the wide stable ESR range. Output capacitor of larger capacitance can reduce noise and improve load-transient response, stability, and PSRR. The output capacitor should be located not more than 0.5" from the VOUT pin of the RT9181 and returned to a clean analog ground.

Note that some ceramic dielectrics exhibit large capacitance and ESR variation with temperature. It may be necessary to use  $2.2\mu\text{F}$  or more to ensure stability at temperatures below  $-10^\circ\text{C}$  in this case. Also, tantalum capacitors,  $2.2\mu$  or more may be needed to maintain capacitance and ESR in the stable region for strict application environment.

Tantalum capacitors maybe suffer failure due to surge current when it is connected to a low-impedance source of power (like a battery or very

large capacitor). If a tantalum capacitor is used at the input, it must be guaranteed to have a surge current rating sufficient for the application by the manufacture.

**Load-Transient Considerations**

The RT9181 load-transient response graphs show two components of the output response: a DC shift from the output impedance due to the load current change, and the transient response. The DC shift is quite small due to the excellent load regulation of the IC. Typical output voltage transient spike for a step change in the load current from 0mA to 50mA is tens mV, depending on the ESR and ESL of the output capacitor. Increasing the output capacitor's value and decreasing the ESR and ESL attenuates the overshoot.

**Reverse Current Path**

The power transistor used in the RT9181 has an inherent diode connected between each regulator input and output (see Fig.1). If the output is forced above the input by more than a diode-drop, this diode will become forward biased and current will flow from the VOUT terminal to VIN. This diode will also be turned on by abruptly stepping the input voltage to a value below the output voltage. To prevent regulator mis-operation, a Schottky diode could be used in the applications where input/output voltage conditions can cause the internal diode to be turned on (see Fig.2). As shown, the Schottky diode is connected in parallel with the internal parasitic diode and prevents it from being turned on by limiting the voltage drop across it to about  $0.3\text{V} < 100\text{mA}$  to prevent damage to the part.

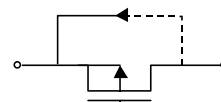

Fig. 1

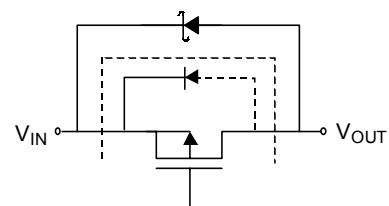
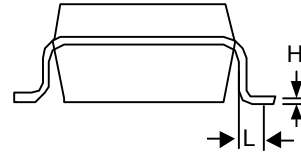
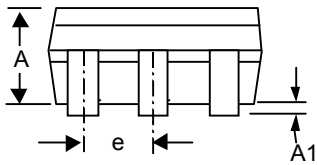
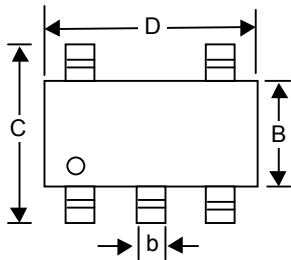

Fig. 2

Package Information



Symbol	Dimensions In Millimeters		Dimensions In Inches	
	Min	Max	Min	Max
A	0.889	1.295	0.035	0.051
A1	0.000	0.152	0.000	0.006
B	1.397	1.803	0.055	0.071
b	0.356	0.559	0.014	0.022
C	2.591	2.997	0.102	0.118
D	2.692	3.099	0.106	0.122
e	0.838	1.041	0.033	0.041
H	0.102	0.254	0.004	0.010
L	0.356	0.610	0.014	0.024

SOT- 25 Surface Mount Package





**RICHTEK TECHNOLOGY CORP.**

Headquarter

6F, No. 35, Hsintai Road, Chupei City

Hsinchu, Taiwan, R.O.C.

Tel: (8863)5510047 Fax: (8863)5537749

**RICHTEK TECHNOLOGY CORP.**

Taipei Office (Marketing)

8F-1, No. 137, Lane 235, Paochiao Road, Hsintien City

Taipei County, Taiwan, R.O.C.

Tel: (8862)89191466 Fax: (8862)89191465

Email: [marketing@richtek-ic.com.tw](mailto:marketing@richtek-ic.com.tw)