

Typical Applications

- Multimode W-CDMA/GSM/DCS/EDGE
- W-CDMA Systems
- GSM Systems

Product Description

The RF2689 is an integrated complete IF AGC amplifier and quadrature demodulator designed for the receive section of W-CDMA and GSM/DCS applications. It is designed to amplify received IF signals, while providing 70dB of gain control range, a total of 90dB gain, and demodulate to baseband I and Q signals. This circuit is designed as part of RFMD's multimode W-CDMA/GSM/DCS chipset, which also includes the RF2688 W-CDMA/GSM/DCS transmit modulator and IF AGC/Upconverter. The IC is manufactured on an advanced 25GHz F_T Silicon Bi-CMOS process, and is packaged in a 20-pin, 4mmx4mm, leadless chip carrier.

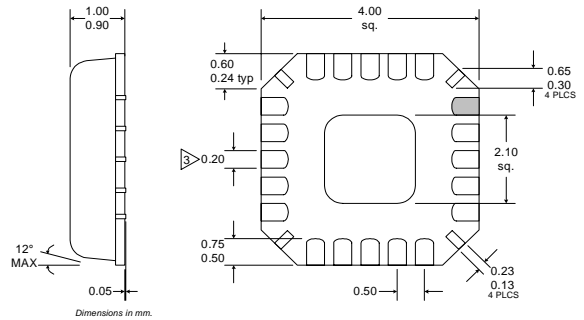

- NOTES:
- 1 Shaded lead is Pin 1.
 - 2 Pin 1 identifier must exist on top surface of package by identification mark or feature on the package body. Exact shape and size is optional.
 - 3 Dimension applies to plated terminal: to be measured between 0.02 mm and 0.25 mm from terminal end.
 - 4 Package Warpage: 0.05 mm max.
 - 5 Die Thickness Allowable: 0.305 mm max.

7
QUADRATURE DEMODULATORS

Optimum Technology Matching® Applied

- Si BJT
- GaAs HBT
- GaAs MESFET
- Si Bi-CMOS
- SiGe HBT
- Si CMOS

Package Style: LCC, 20-Pin, 4 x 4

- Features
- Digitally Controlled Power Down Mode
 - 2.7V to 3.3V Operation
 - Digital LO Quadrature Divide-by-8
 - IF AGC Amp with 70dB Gain Control
 - 80dB Maximum Voltage Gain

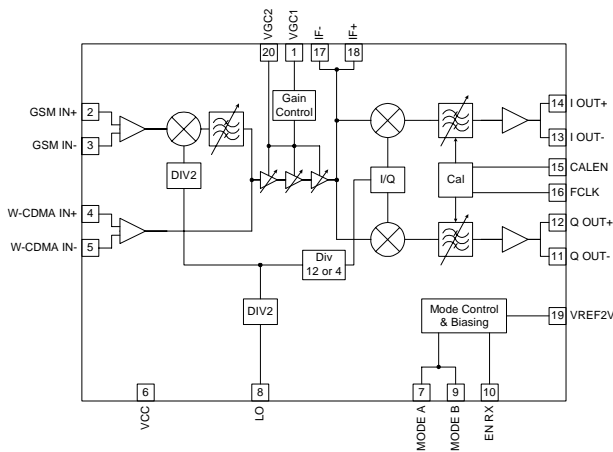

Functional Block Diagram

Ordering Information

RF2689	W-CDMA/GSM/DCS Receive AGC and Demodulator
RF2689 PCBA	Fully Assembled Evaluation Board

RF Micro Devices, Inc.
7625 Thorndike Road
Greensboro, NC 27409, USA

Tel (336) 664 1233
Fax (336) 664 0454
<http://www.rfmd.com>

Absolute Maximum Ratings

Parameter	Rating	Unit
Supply Voltage	-0.5 to +5	V _{DC}
Power Down Voltage (V _{PD})	-0.5 to V _{CC} +0.7	V _{DC}
Input RF Power	+3	dBm
Ambient Operating Temperature	-40 to +85	°C
Storage Temperature	-40 to +150	°C



Caution! ESD sensitive device.

RF Micro Devices believes the furnished information is correct and accurate at the time of this printing. However, RF Micro Devices reserves the right to make changes to its products without notice. RF Micro Devices does not assume responsibility for the use of the described product(s).

Parameter	Specification			Unit	Condition
	Min.	Typ.	Max.		
W-CDMA Mode					
IF Frequency		190		MHz	Temp=25°C, V _{CC} =3V, Z _{LOAD} =60kΩ diff., LO=1520MHz @ -10dBm, Z _{SOURCE} =500Ω diff.
W-CDMA IF Input Impedance		1200		Ω	
		2400		Ω	Single-ended Balance. An external resistor across the differential input is used to define the input impedance.
LO Frequency		1520		MHz	Single-ended. Pin-to-Pin voltage gain. Note: 10dB additional voltage gain in input match 50Ω to 500Ω.
LO Input Level	-20	-10	0	dBm	
LO Input Impedance		50		Ω	Defined with external 10kΩ resistor in series with V _{GC1} pin. Analog gain control. Blockers at 10MHz and 20MHz offset. Maximum Gain. V _{GC} =2.4V Minimum Gain. V _{GC} =0.3V
Maximum Voltage Gain	76	80		dB	
Minimum Voltage Gain	5	10	15		Maximum Gain. V _{GC} =2.4V Minimum Gain V _{GC} =0.3V
Gain Variation versus V _{CC} and Temperature	-3	±1	+3	dB	
Gain Control Voltage	0.3		2.4	V	Measured differentially. Out of band blocker causing 1dB of inband gain compression. Blocker at 5MHz. Maximum Gain. V _{GC} =2.4V Minimum Gain. V _{GC} =0.3V
Input IP3	-52	-48		dBm	Butterworth third order, F _C 2.5M±10% Calibrated. F _{CLK} =13MHz, 3dB rolloff from 1MHz offset
	-5	0		dBm	
Noise Figure		5	7	dB	A measure of IQ gain match and IQ quadrature accuracy. Measured for baseband frequencies 100kHz to 2.5MHz.
		56	58	dB	
Inband Output 1dB Compression	1.5	2.0		V _{P-P}	Resistive Load Impedance. Differentially across op pins. Capacitive Load Impedance. To ground.
Compression				dBm	
				dBm	Resistive Load Impedance. Differentially across op pins. Capacitive Load Impedance. To ground.
				dBm	
Baseband 3dB Bandwidth	2.25	2.5	2.75	MHz	Resistive Load Impedance. Differentially across op pins. Capacitive Load Impedance. To ground.
Sideband Suppression			27	dB	
DC Offset			±40	mV	Resistive Load Impedance. Differentially across op pins. Capacitive Load Impedance. To ground.
Baseband External Load		20	60	kΩ	
			5	pF	Resistive Load Impedance. Differentially across op pins. Capacitive Load Impedance. To ground.
Output DC Voltage	V _{CC} -1.3	V _{CC} -1.6	V _{CC} -1.9	V	
IQ Amplitude Balance		±0.2	±0.5	dB	V _{GC} =0.3V, P _{IN} =-30dBm
IQ Phase Balance		±2	±5	degree	V _{GC} =0.3V, P _{IN} =-30dBm

Parameter	Specification			Unit	Condition
	Min.	Typ.	Max.		
GSM/DCS Mode					Temp=25°C, V _{CC} =3V, Z _{LOAD} =60kΩ diff., LO=1080MHz @ -10dBm, Z _{SOURCE} =500Ω
IF Frequency		225		MHz	
2nd IF Frequency		45		MHz	
LO Frequency		1080		MHz	
LO Input Level	-20	-10	0	dBm	
LO Input Impedance		50		Ω	Single-ended.
Maximum Voltage Gain	77	83		dB	V _{GC} =0.5V to 2.4V Pin-to-Pin voltage gain. Note: 10dB additional voltage gain in input match 50Ω to 500Ω.
Minimum Voltage Gain	-15	-10	-5	dB	
Gain Variation versus V _{CC} and Temperature	-3	±2	+3	dB	
Gain Control Voltage	0.3		2.4	V	Defined with external 10kΩ resistor in series with GC pin. Analog gain control.
Noise Figure		6	8	dB	Maximum Gain. V _{GC} =2.4V
		80	82		Minimum Gain V _{GC} =0.3V
Input IP3					Blockers at 800kHz and 1650kHz offset.
	-54	-49		dBm	Maximum Gain. V _{GC} =2.4V
	-5	0		dBm	Minimum Gain. V _{GC} =0.3V
Inband Output 1dB Compression	1.5	2.5		V _{P-P}	Maximum Gain. Measured differentially.
Compression					Out of band blocker causing 1dB of inband gain compression. Blocker at 800kHz offset.
		-65		dBm	Maximum Gain. V _{GC} =2.4V
		-17		dBm	Minimum Gain. V _{GC} =0.3V
GSM IF Input Impedance		1200		Ω	Single-ended
		2400		Ω	Balance. An external resistor across the differential input is used to define the input impedance.
					Butterworth third order, F _C 250k±10%
Baseband 3dB Bandwidth	225	250	275	kHz	3dB rolloff from 50kHz offset
	100		400	kHz	Calibrated. F _{CLK} =13MHz
Sideband Suppression			27	dB	Uncalibrated.
					A measure of IQ gain match and IQ quadrature accuracy. Measured for baseband frequencies 100kHz to 2.5MHz.
DC Offset			±60	mV	
Baseband External Load		20	60	kΩ	Resistive Load Impedance. Differentially across op pins.
			5	pF	Capacitive Load Impedance. To ground.
Output DC Voltage	V _{CC} -1.3	V _{CC} -1.6	V _{CC} -1.9	V	
IQ Amplitude Balance		±0.2	±0.5	dB	V _{GC} =0.3V, P _{IN} =-30dBm
IQ Amplitude Balance		±2	±5	degree	V _{GC} =0.3V, P _{IN} =-30dBm

Parameter	Specification			Unit	Condition
	Min.	Typ.	Max.		
Auto Calibration					
F _{CLK} Input Frequency ¹		13		MHz	Single-ended. Disabled after calibration.
F _{CLK} Signal Level	0.4		1.0	V _{P-P}	
F _{CLK} Pin Input Impedance		20		kΩ	
Calibration Time			200	us	
Current, Auto Cal.			1	mA	
Current, Once Auto Cal Finished			1	uA	
DC Specifications					
Supply Voltage	2.7	3.0	3.3	V	
Current Consumption					
Power Down		<1		μA	
W-CDMA Standby		5	6	mA	
W-CDMA		8	10	mA	
GSM/DCS Standby		5	6	mA	
GSM/DCS		9	12	mA	
Logic Levels					
V _{EN} High Voltage	1.8		V _{CC}	V	
V _{EN} Low Voltage	0		0.5	V	

¹Bondout option available for 15.36MHz, 18MHz and 19MHz.

Mode Control

Logic

EN RX Chip Enable If EN=0 then the whole IC is powered down

Mode Control Truth Table

Mode	EN RX	Mode B	Mode A
Power Down	0	X	X
GSM/DCS RX Warm-Up	1	0	1
GSM/DCS RX	1	1	1
W-CDMA RX Warm-Up	1	0	0
W-CDMA RX	1	1	0

Auto Calibration Mode

The filters are automatically tuned when the CALEN pin goes high. The filters are reset to a nominal value whenever the CALEN pin goes low. The auto calibration circuitry is independent of the “Mode A/B” and the EN RX control pins. The EN RX and CALEN pins can be connected together if desired.

Truth Table

Mode	W-CDMA Input Amp	GSM Input Amp & 1st Mixer	Fixed Divider	GSM Divider	Second Dividers	VGA	Demod	Baseband & Filters
Power Down	0	0	0	0	0	0	0	0
GSM/DCS RX Warm-Up	0	0	1 (div 2)	0 (div 2)	0 (div 12)	0	0	0
GSM/DCS RX	0	1	1 (div 2)	1 (div 2)	1 (div 12)	1	1	1 (250kHz)
W-CDMA RX Warm-Up	0	0	1 (div 2)	0	1 (div 4)	0	0	0
W-CDMA RX	1	0	1 (div 2)	0	0 (div 4)	1	1	1 (2.5MHz)

Pin	Function	Description	Interface Schematic
1	VGC1	Analog gain control. Valid control voltage ranges are form 0.5V to 2.5V. These voltages are valid with a 10kΩ resistor in series with GC pin.	
2	GSM IN+	GSM IF balanced input. Input internally DC-biased.	
3	GSM IN-	Same as pin 2.	
4	W-CDMA IN+	W-CDMA IF balanced input. Input internally DC-biased.	
5	W-CDMA IN-	Same as pin 4.	See pin 4.
6	VCC	Supply	
7	MODE A	DCS/GSM/GSM RX/W-CDMA mode selection.	
8	LO	LO input pin. Input internally DC-biased.	
9	MODE B	Warm-up mode enable. The input LO buffers and divider chains are enabled.	
10	EN RX	Chip enable.	
11	Q OUT-	Complementary output to Q OUT+.	
12	Q OUT+	Balanced baseband output.	
13	I OUT-	Complementary output to I OUT+.	
14	I OUT+	Balanced baseband output.	
15	CALEN	Calibration enable.	
16	FCLK	F _{CLK} clock reference for the automatic calibration circuitry.	
17	IF-	Complementary output to IF+.	
18	IF+	IF test point output.	
19	VREF2V	2V voltage reference decouple.	
20	VGC2	Gain control decouple.	
Pkg Base	Die Flag	Ground.	

Application Notes

Voltage Gain Measurement Set-up

The evaluation board uses a unity voltage gain Op-Amp to simulate the 60kΩ differential load impedance condition for the chip. The 50Ω output impedance of Op-Amp makes the use of a 50Ω spectrum analyzer power measurement possible. The power gain measured will be considered as RAW Gain. The input impedance of the chip is 500Ω differential by adding a parallel 680Ω resistor. The input transformer matches 50Ω to 500Ω and results in 10dB difference between voltage gain and power gain, hence, the voltage gain of the chip is RAW Gain minus 10dB. Because the input transformer loss is 0.8dB, it needs to be added to the gain. Since the Op-Amp has the unity voltage gain, the voltage at the evaluation board output is the same as the voltage at chip I or Q output. Therefore, the voltage gain of the chip with 60kΩ load can be calculated by

$$G_v = \text{RAW Gain} - 10 + 0.8 \text{ (dB)}$$

Input IP3 Measurement

The input IP3 measurement is based on a two tone inter-modulation test condition from the 3GPP standard, which specifies two tones with offset frequencies at 10MHz and 20MHz. Due to the on-chip baseband filtering, the two tone output is attenuated and cannot be seen. Since the only parameter observable is the IM3 product, the input IP3 then is calculated by

$$IIP3 = P_{in} + 0.5 * (P_{in} + \text{RAW Gain} - IM3)$$

Noise Figure Measurement

The noise figure measurement is based on the noise figure definition $NF = N_O - N_I - \text{Gain}$, where N_O is the output noise density, N_I is the input noise density (-174dBm/Hz when no input signal is applied) and Gain is the RAW Gain. The output noise density N_O is measured at 1MHz offset when no signal input is applied. The NF is calculated by $NF = N_O - 174 \text{ dBm/Hz} - \text{RAW Gain}$. Since the I and Q re-combination will provide 3dB extra for signal-to-noise ratio, the actual noise figure is should be reduced by 3dB. In addition, noise figure should be reduced by the input transformer loss of 0.8dB. Therefore, the NF is calculated by

$$NF = N_O + 174 - \text{RAW Gain} - 3 - 0.8 \text{ (dB)}$$

1 dB Gain Compression Point Voltage at Baseband Output

The device has a relatively constant 1 dB gain compression point versus V_{GC} . Gain compression is tested with a CW signal with 60kΩ load differential.

How to Calculate the Power Gain of the Demodulator

In the system analysis for cascaded gain, noise and IP, it is often required to calculate the power gain of the demodulator chip itself in matched load condition. Below is an example on how to determine this power gain value.

For this example, the load impedance is 60kΩ differential, the output AC impedance of the I or Q port is 500Ω, the measured RAW Gain is 95dB.

First, the power gain from the input of the chip to the input of Op-Amp needs to be calculated. Since the voltage at the 50Ω load and the voltage at Op-Amp input are the same, the difference of the power gain across the Op-Amp is the ratio of load impedances. Hence, the power gain to the Op-Amp input is $95 \text{ dB} - 10 \log(60000/50) = 95 - 30 = 65 \text{ dB}$.

Second, the power gain of the demodulator itself with matched load is calculated. The mismatch coefficient α is determined by the mismatch coefficient equation

$$\alpha = 10 \log \frac{4R_S R_L}{(R_S + R_L)^2} = 10 \log \frac{4 \cdot 500 \cdot 60000}{(500 + 60000)^2} = -15 \text{ dB}$$

Since the power gain to the input of the Op-Amp $G_P' = \alpha G_P$ where G_P is the power gain of demodulator for matched load. Therefore, the demodulator power gain is $65+15 = 80$ dB.

AC Coupling in Evaluation Board

The output I and Q baseband signal is AC coupled for evaluation purposes only. The high-pass corner frequency is at $1/(2\pi RC) = 1/(6.28 * 30k\Omega * 100nF) = 56$ Hz.

I and Q Output DC Voltage and Its Offset

Although the I and Q output is AC coupled on the evaluation board, in most applications, it would be DC coupled to the ADC input buffer. The DC voltage at the IC output is $V_{CC} - 1.6V$ with a possible variation of $\pm 0.3V$ due to temperature and tolerance. The differential circuit asymmetry would cause common mode DC offset to the extent of $\pm 40mV$.

Baseband Filter Calibration Process

The BB (baseband) filter calibration process is same for both WCDMA and GSM/DCS. After calibration is done, the WCDMA mode sets the circuitry to have a 3dB bandwidth of 2.5MHz, the GSM/DCS mode (if the chip has GSM/DCS mode) sets the circuitry to have a 3dB bandwidth of 250kHz.

The BB filter in the I and Q path needs to be calculated every time after power down. When the FCLK pin is connected to a signal generator with 0dBm output level at 13.0MHz, a logic high at CALEN pin for 200 μ s will calibrate the filter to have 2.5MHz bandwidth with 10% accuracy when WCDMA mode is set, or to 250kHz bandwidth with 10% accuracy when GSM mode is set. The calibration is done when the chip is powered on only. Calibration is independent from all other conditions, e.g. the chip enable could be off.

The calibration circuitry consumes 400 μ A. When the calibration sequence is complete after 200 μ s, the I_{CC} drops to 0mA.

The 3dB bandwidth is defined to be from the reference level at 1MHz for WCDMA and at 50kHz for GSM/DCS. The 3dB bandwidth is independent of V_{GC} and V_{CC} .

The filter can also be calibrated with different clock frequencies from 10MHz to 30MHz to tune the bandwidth over -40% to +60% from its default 3dB bandwidth (2.5MHz for WCDMA and 250kHz for GSM). The 3dB bandwidth is linear with clock frequency.

Pin Out

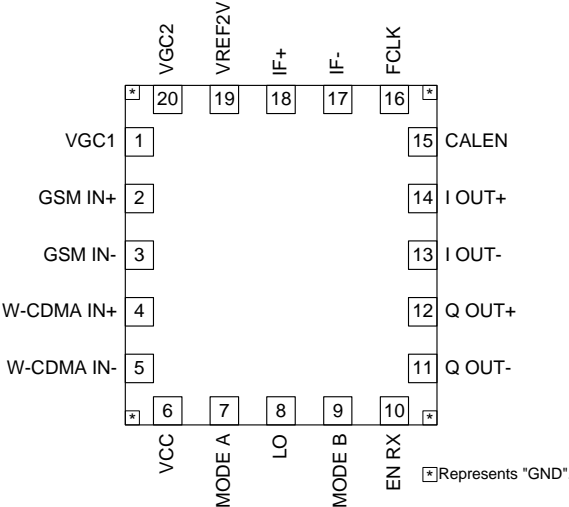

Application Schematic

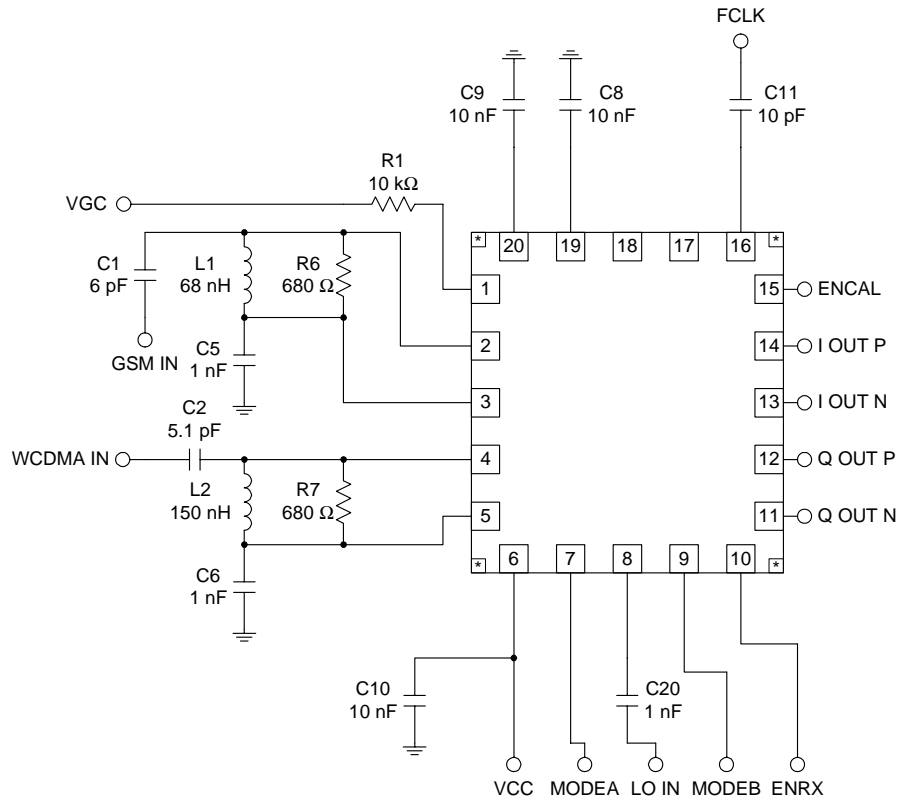

7
QUADRATURE
DEMODULATORS

Evaluation Board Schematic (Download [Bill of Materials](http://www.rfmd.com) from www.rfmd.com.)

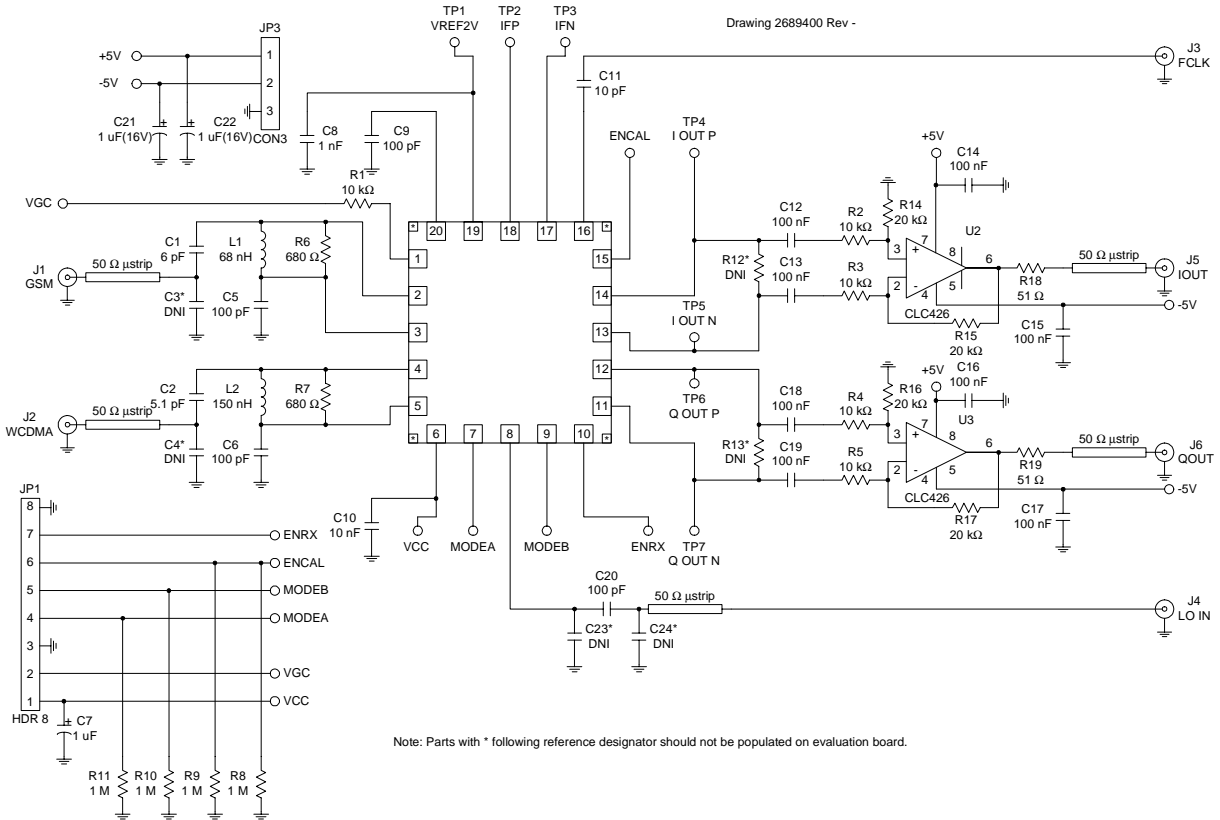

Evaluation Board Layout
3.098" x 3.000"
Board Thickness 0.152", FR-4 Multi Layer

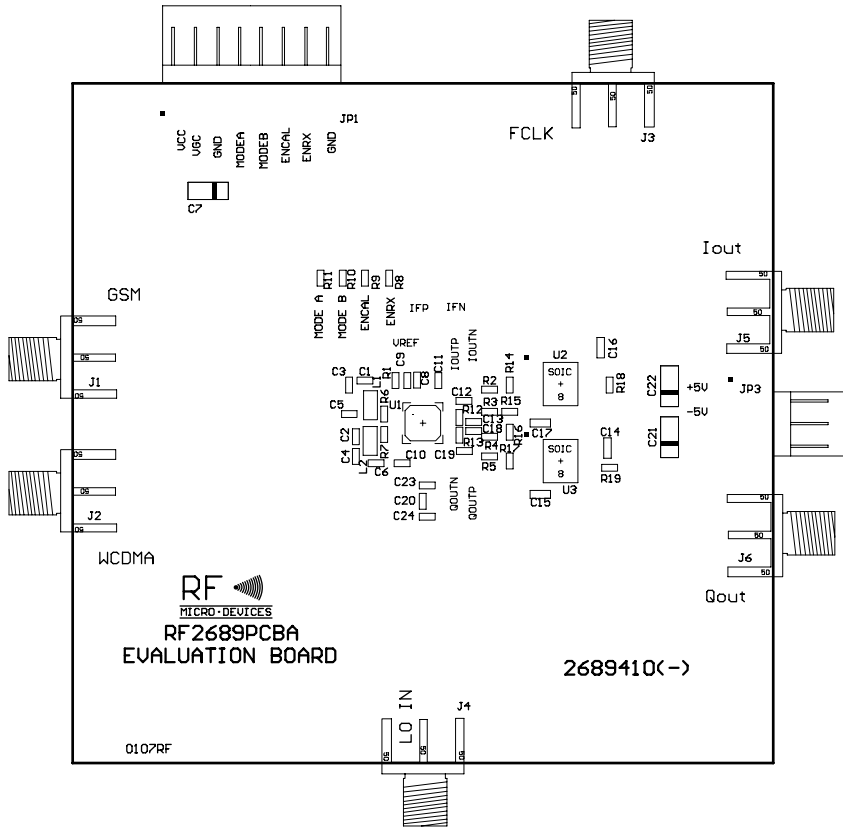

7
QUADRATURE
DEMODULATORS

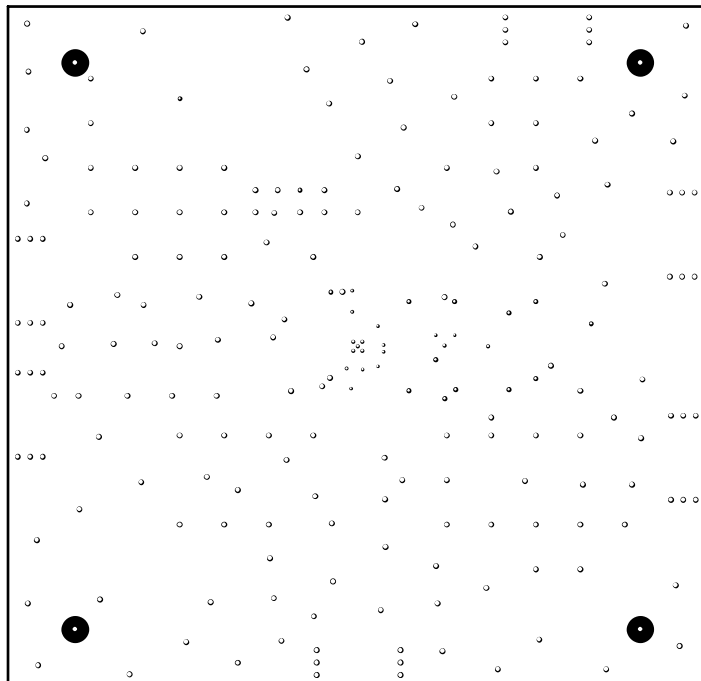
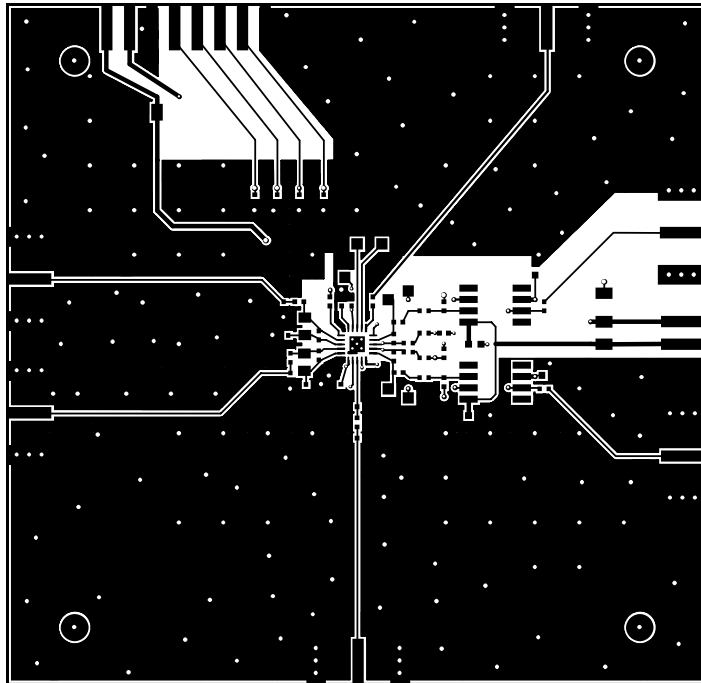

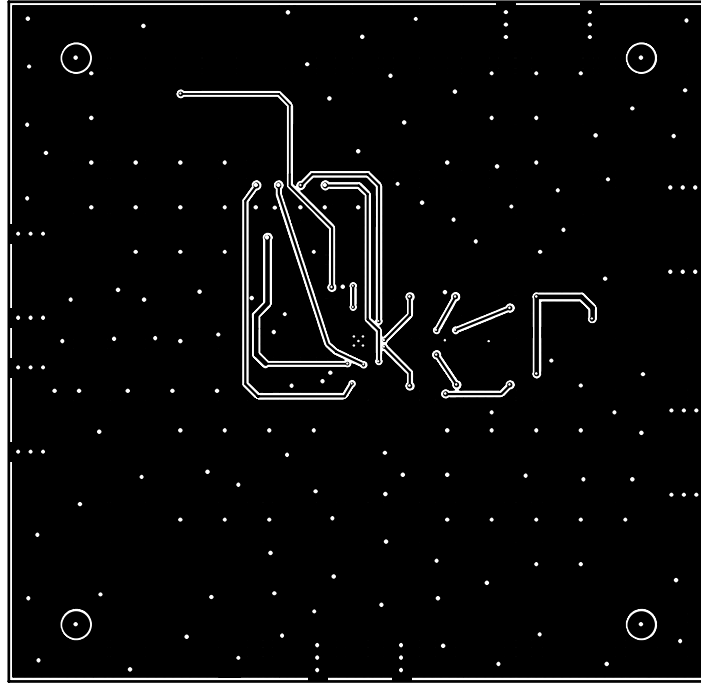

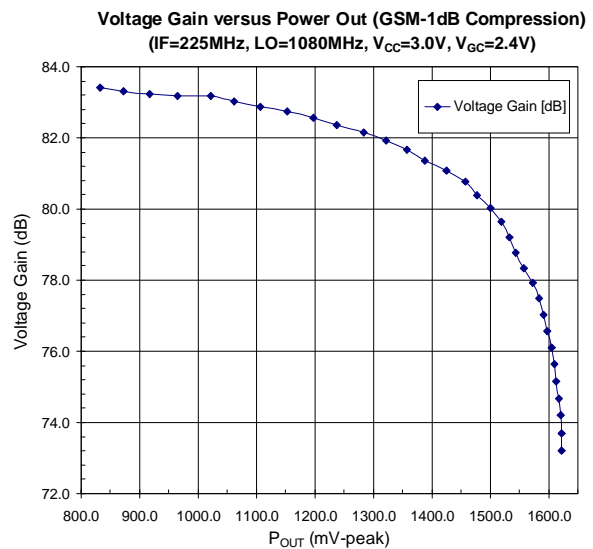
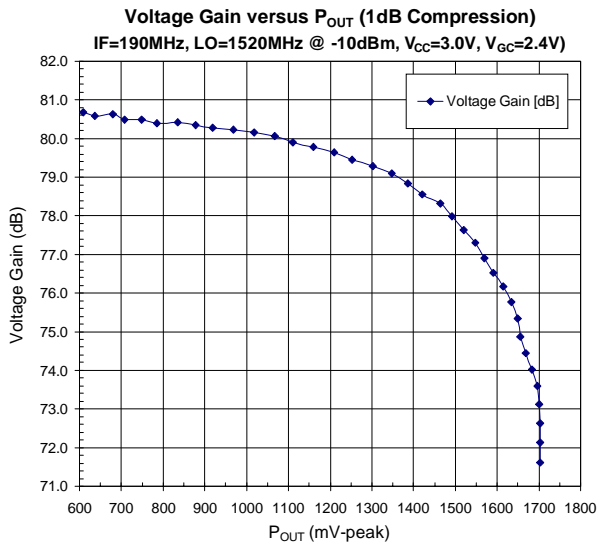
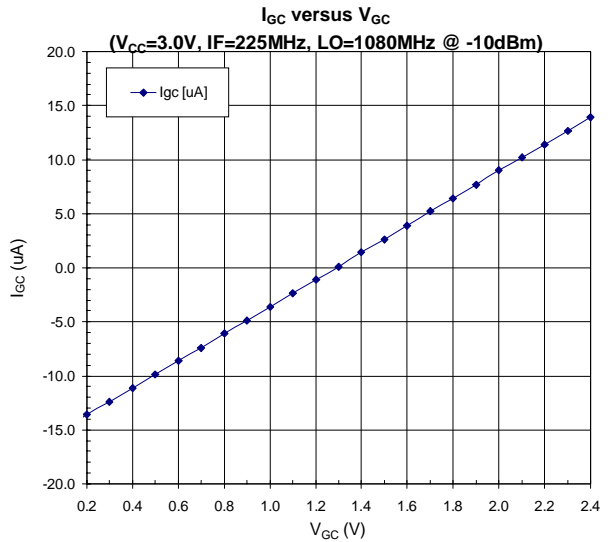
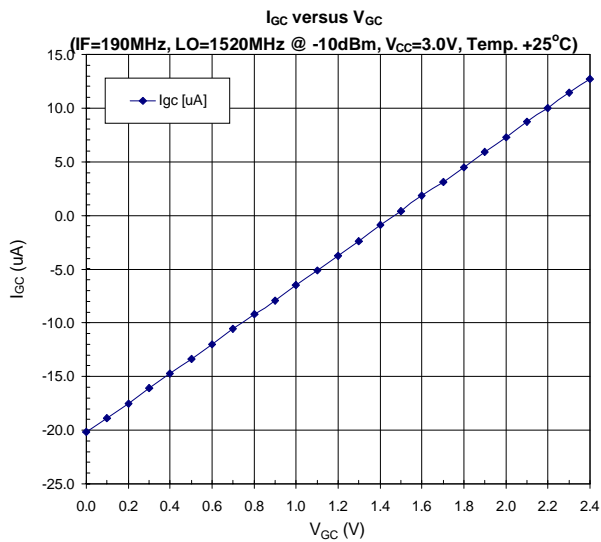
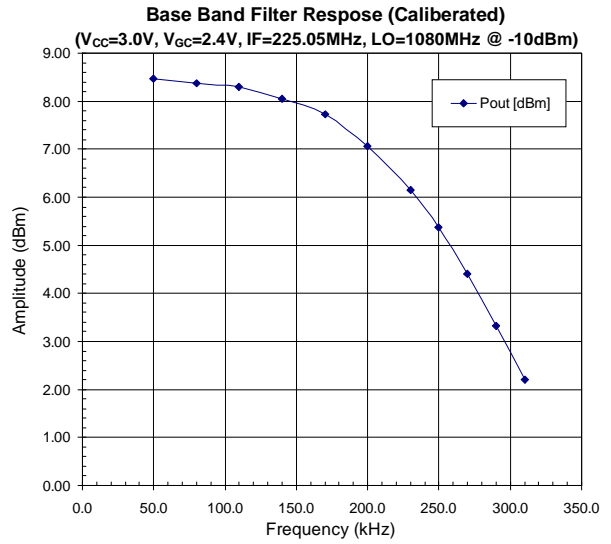
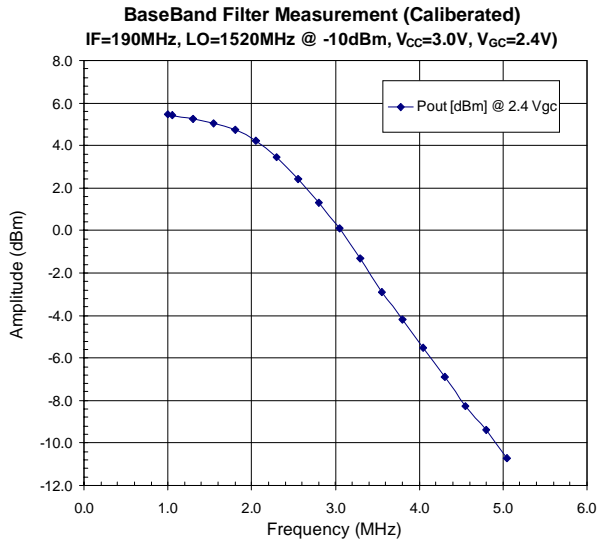

Voltage Gain versus V_{GC} (W-CDMA, Temp +25°C, -40°C, +85°C)

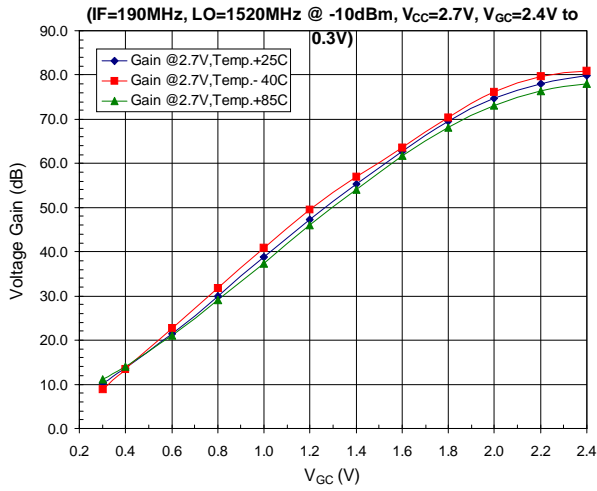

Voltage Gain versus V_{GC} (GSM, Temp. +25°C, -40°C, +85°C)

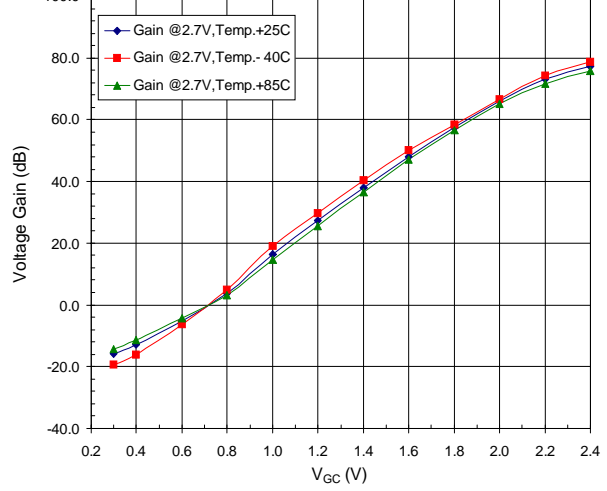

Voltage Gain versus V_{GC} (W-CDMA, Temp. +25°C, -40°C, +85°C)

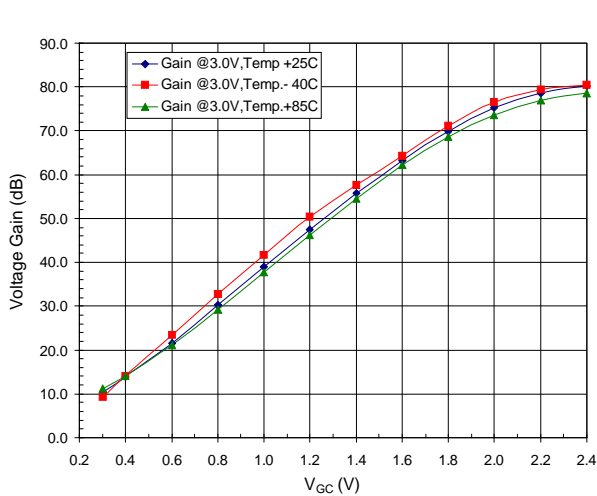

Voltage Gain versus V_{GC} (GSM, Temp.=+25°C, -40°C,+85°C)

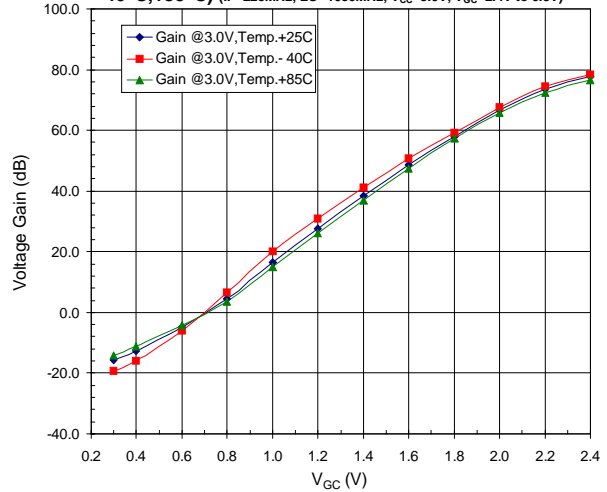

Voltage Gain versus V_{GC} (W-CDMA)

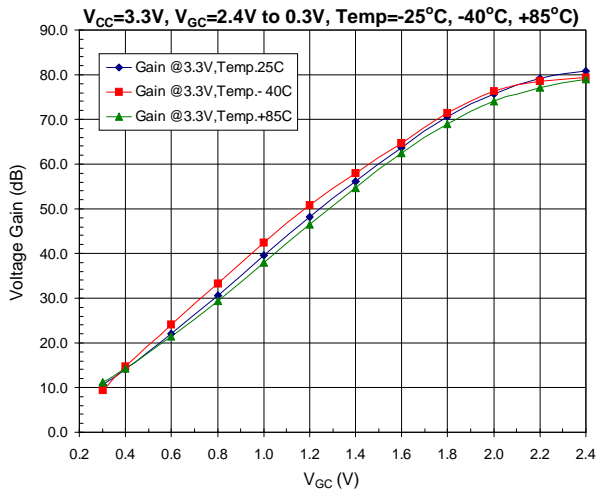

Voltage Gain versus V_{GC} (GSM, Temp. +25°C, -40°C, +85°C)

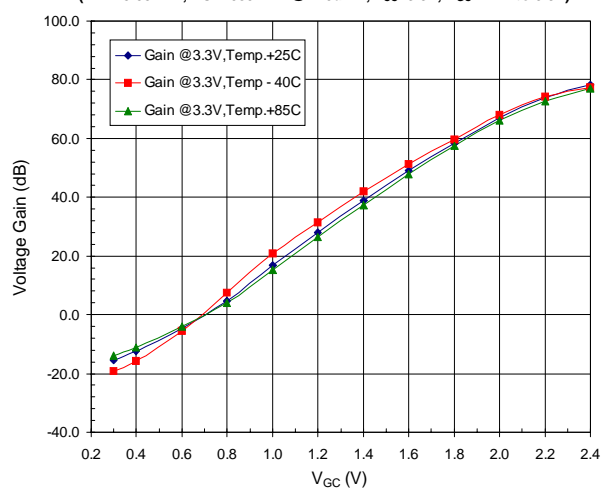

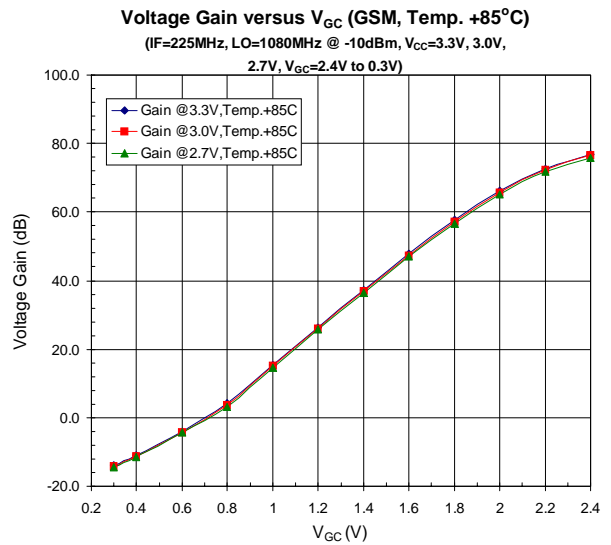
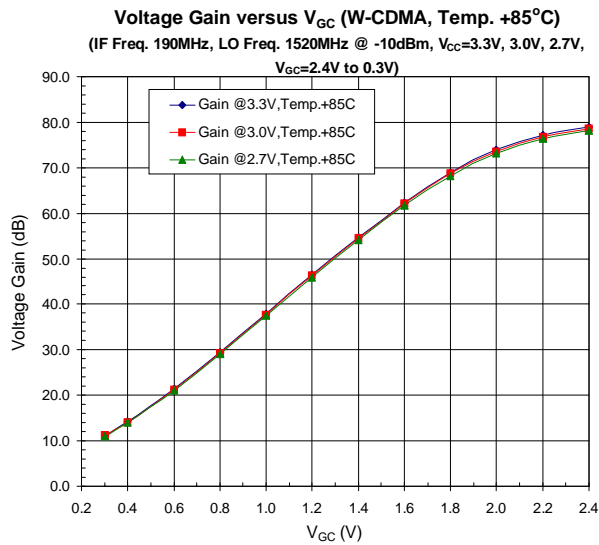
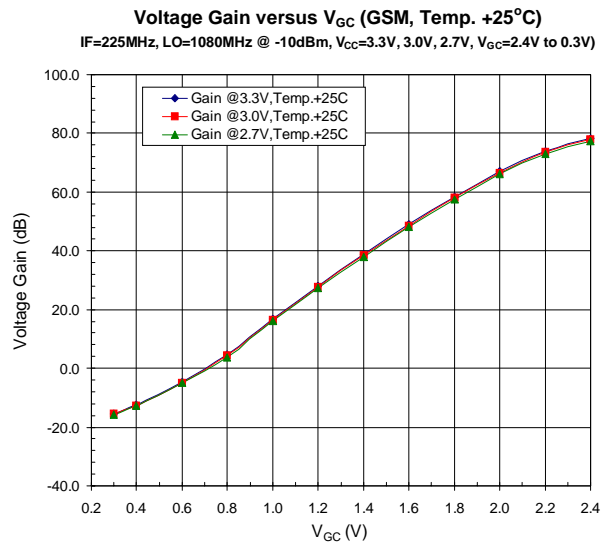
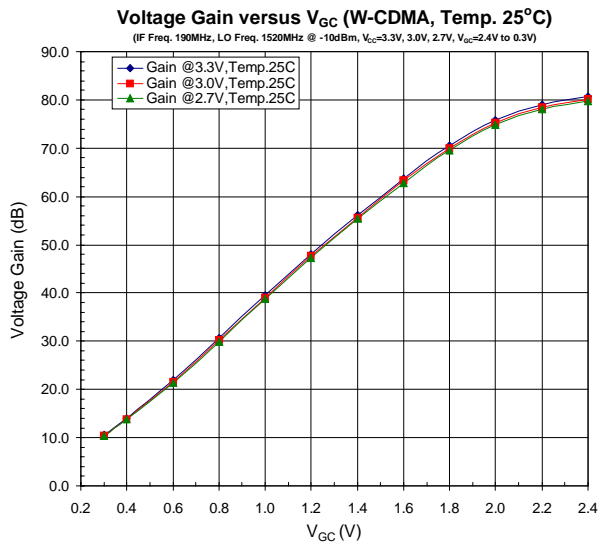
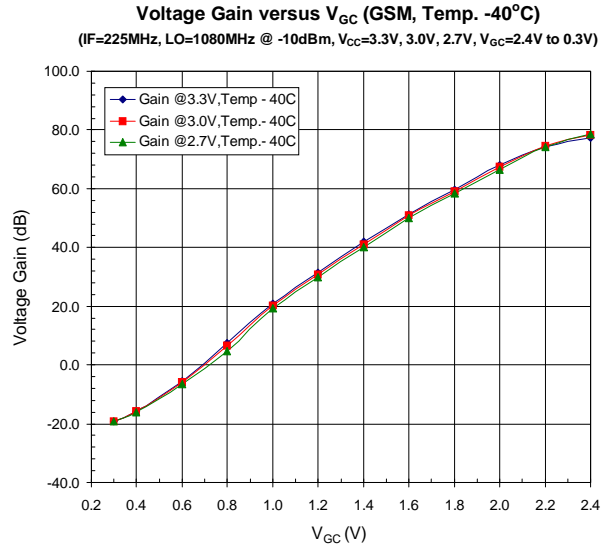
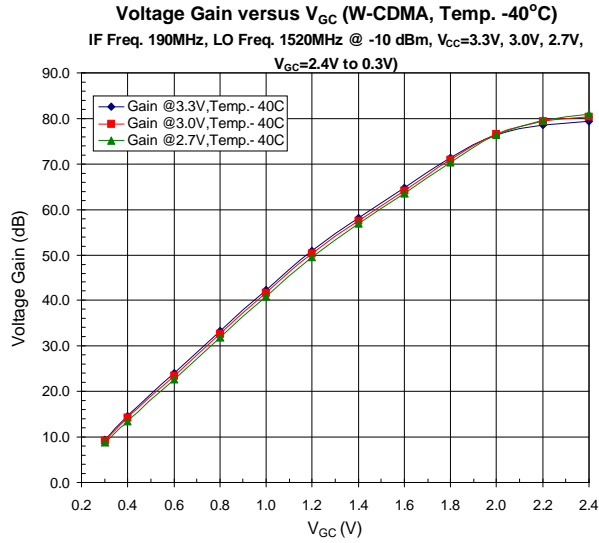

IIP3 versus V_{GC} (W-CDMA, Temp. +25°C, -40°C, +85°C)
 (IF=190MHz, LO=1520MHz @ -20dBm, V_{CC} =2.7V, V_{GC} =2.4V to 0.3V)

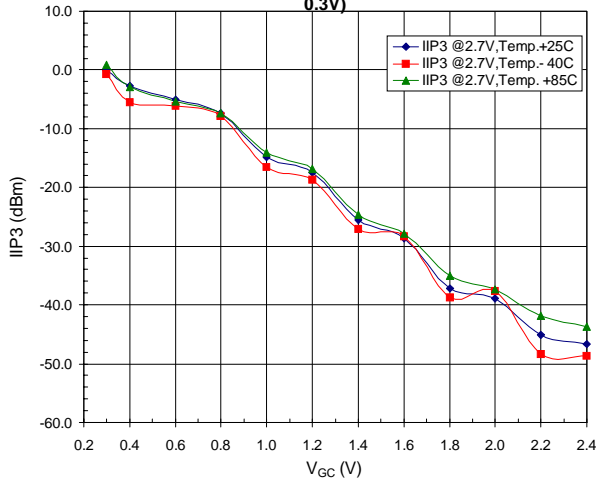

IIP3 versus V_{GC} (GSM, Temp. +25°C, -40°C, +85°C)
 (IF Freq. 225.80MHz/226.650MHz, LO=1080MHz @ -10dBm, V_{CC} =2.7V, V_{GC} =2.4V to 0.3V)

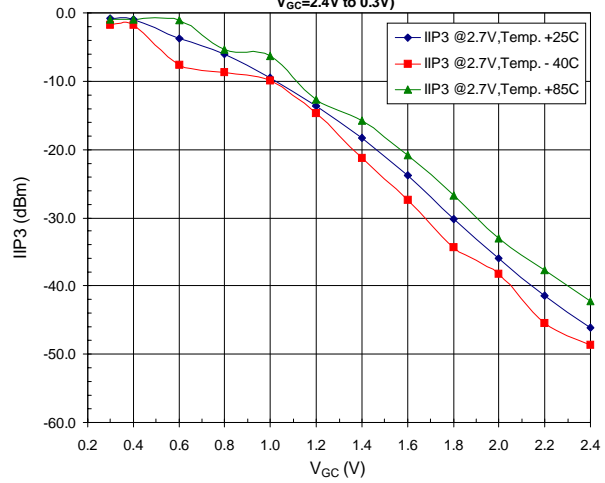

IIP3 versus V_{GC} (W-CDMA, Temp. +25°C, -40°C, +85°C)
 (IF=190MHz, LO=1520MHz @ -10dBm, V_{CC} =3.0V, V_{GC} =2.4V to 0.3V)

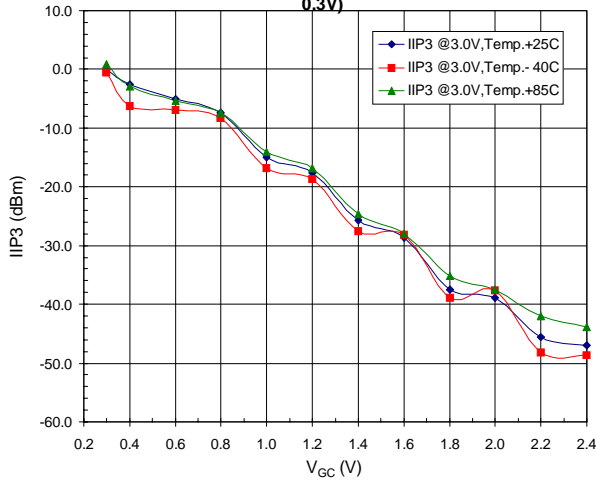

IIP3 versus V_{GC} (GSM, Temp. +25°C, -40°C, +85°C)
 (IF=225MHz, LO=1080MHz @ -10dBm, V_{CC} =3.0V, V_{GC} =2.4V to 0.3V)

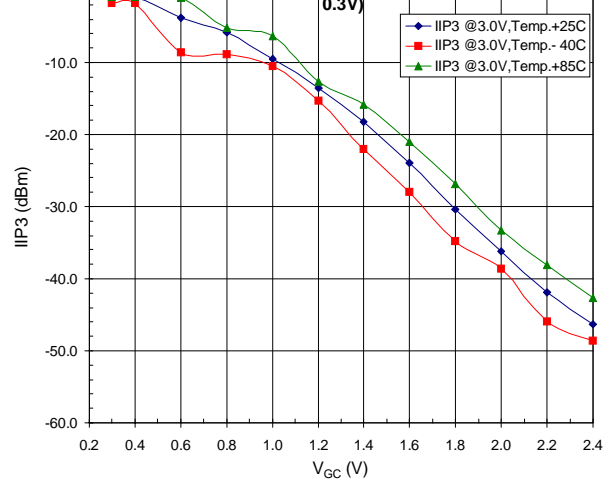

IIP3 versus V_{GC} (W-CDMA, Temp. +25°C, -40°C, +85°C)
 (IF=190MHz, LO=1520MHz @ -10dBm, V_{CC} =3.3V, V_{GC} =2.4V to 0.3V)

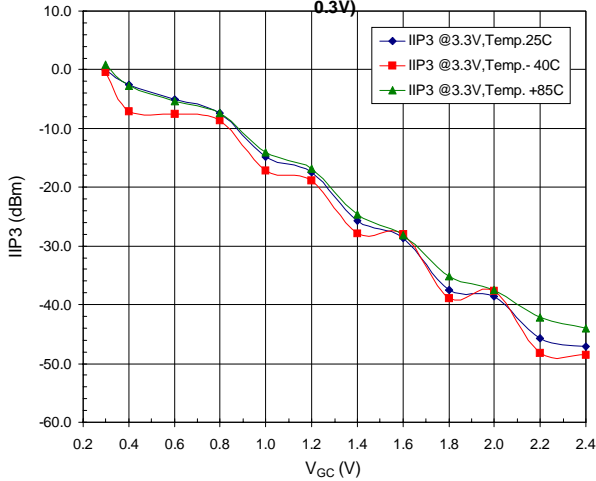

IIP3 vs V_{GC} (GSM, Temp.+25°C, -40°C, +85°C)
 IF=225.80/226.650MHz, LO=1080MHz @ -10dBm, V_{CC} =3.3V, V_{GC} =2.4V to 0.3V)

