

RF250

Rx ASIC for CDMA, AMPS, and PCS Applications

The RF250 Application-Specific Integrated Circuit (ASIC) is a triple-mode, dual-band receiver (Rx) intended for use in Code Division Multiple Access (CDMA) portable phones in both cellular and Personal Communications System (PCS) bands. As a dual mode IC, it can be used in CDMA mode or Advanced Mobile Phone System (AMPS) mode.

The device incorporates all the components required to implement the receiver front end and the In-Phase and Quadrature (I/Q) demodulator stages except for the filter blocks and PCS Low Noise Amplifier (LNA). Besides a cellular band LNA, there are separate mixers for AMPS, CDMA 800 MHz, and PCS bands. The AMPS mixer output is single-ended, followed by the AMPS Intermediate Frequency (IF) Surface Acoustic Wave (SAW) filter. The cellular and PCS mixers have balanced outputs for the CDMA IF SAW filters. The mixers are followed by an IF Variable Gain Amplifier (VGA) and an I/Q demodulator.

The outputs from the filters are combined through separate buffers at the input of the VGA. The buffers are enabled depending on the selected mode. The VGA has a gain control range greater than 90 dB. There are two VHF oscillators that operate with external tank circuits. They provide signals to the Local Oscillator (LO) for the I/Q demodulator in the cellular and PCS bands.

The noise figure, gain, and third order Input Intercept Point (IIP3) of each stage in the receiver chip are optimized to meet the system requirements for AMPS and CDMA modes as per TIA/EIA-98-B and ANSI J-STD-018 (PCS). Employing silicon bipolar technology, the ASIC is designed for high performance and a high level of integration.

The device package and pinout are shown in Figure 1. A block diagram of the RF250 is shown in Figure 2.

Features

- Supports CDMA/AMPS/PCS1900 modes.
- Three battery cell operation (2.7 V < VCC < 3.6 V).
- Higher level of integration.
- I/Q outputs.
- On-chip 100 to 640 MHz oscillators.
- Low power operation: <60 mA.
- 48-pin Thin Quad Flat Pack (TQFP) package with downset paddle.

Applications

- Tri-mode handsets.
- CDMA and AMPS modes in the cellular band:
 - AMPS
 - CDMA-US
 - CDMA-J
- CDMA mode in the PCS band:
 - US-PCS
 - K-PCS

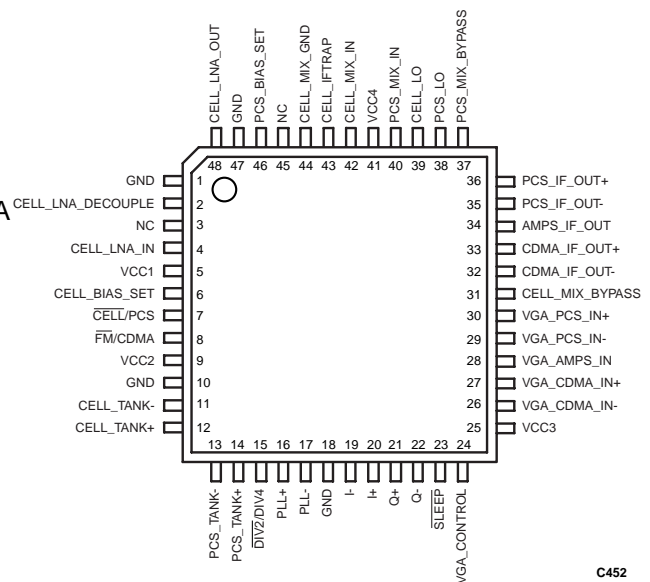

Figure 1. RF250 Rx ASIC Pinout – 48-Pin TQFP Package With Downset Paddle

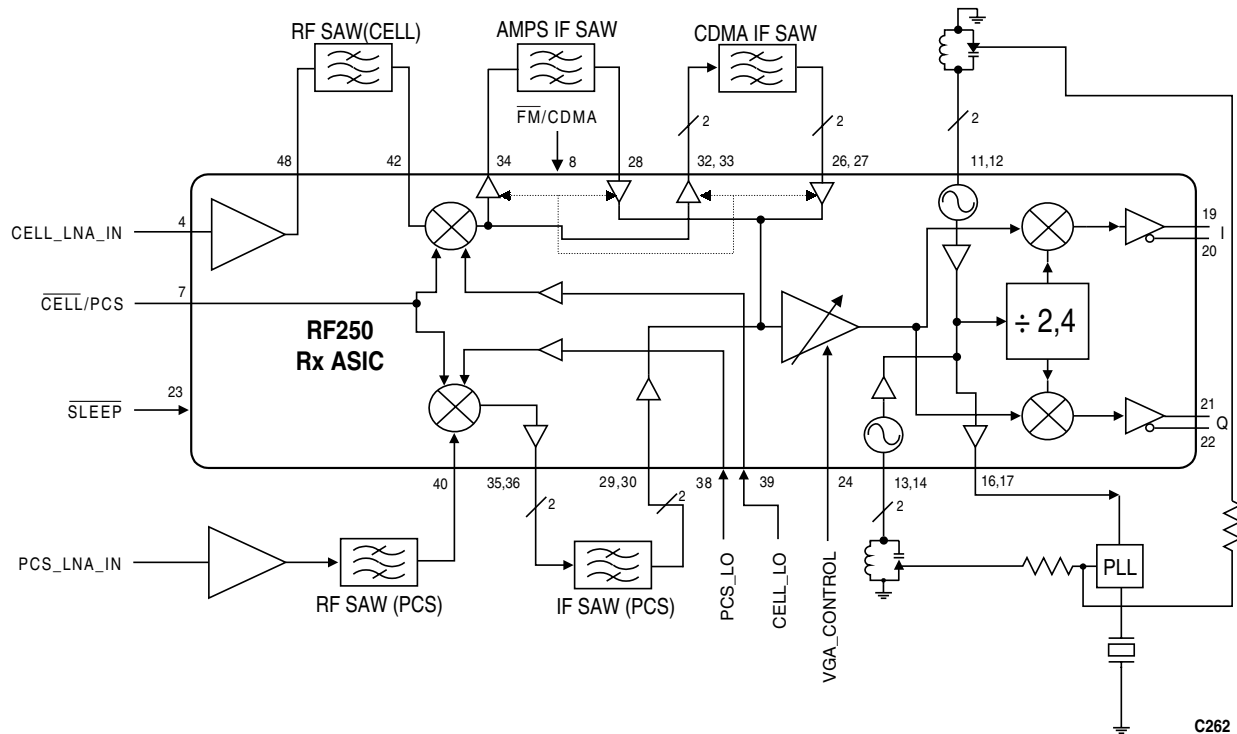

Figure 2. RF250 Rx ASIC Block Diagram

Technical Description

Low Noise Amplifier (LNA). The cellular band LNA is designed with a low noise figure and high linearity to achieve maximum receiver dynamic range. Pin 2, the 800 LNA decouple pin, is required to be grounded through an RF bypass capacitor with minimum trace length. The input and output match are external to the chip.

Mixers. The RF250 Rx ASIC has three independent mixers, one for the PCS band and two for the cellular band (AMPS and CDMA).

The mixers are designed to operate with very low LO powers of -10 dBm. The LO ports are matched internal to the chip.

The cellular band mixers have a high gain and a low noise figure that allow them to meet the system noise figure. The cellular CDMA and PCS mixers have balanced output to drive the IF filters. The AMPS mixer has a single-ended output to match the standard IF SAW filters.

Variable Gain Amplifier (VGA). The high dynamic range required by CDMA handsets is achieved by the VGA, which is common to all modes. The VGA

has a minimum dynamic range of 90 dB with a control voltage of 0.2 to 2.7 volts. The appropriate signal path is switched internal to the device. This eliminates off-chip switching needed to operate this common VGA in cellular AMPS, CDMA, and PCS modes.

I/Q Demodulator. The local oscillator signals are generated on-chip. The I/Q demodulator is internally connected to the VGA output. It is designed to have a very low amplitude and phase imbalance. The I and Q outputs are differential. The DC offsets between the differential outputs and between I and Q channels are designed to be extremely low to facilitate compatibility with baseband Interfaces.

VHF Oscillators. There are two on-chip oscillators, one for the cellular and one for the PCS bands. These Voltage Controlled Oscillators (VCOs) work with external tank circuits and varactor diodes. The outputs of the differential oscillators are buffered and the output is used to drive the prescaler of an external Phase Locked Loop (PLL). The VCOs typically operate at twice the IF frequency and can operate at up to four times the IF frequency.

The local oscillators for the I/Q demodulators are derived by an on-chip frequency divider. The logic signal to select the divider ratio (2 or 4) is available on Pin 15 (DIV2/DIV4).

Mode Control. The operation of the chip is controlled by signals at Pin 7 (CELL/PCS), Pin 8 (FM/CDMA), Pin 23 (SLEEP), and the DIV2/DIV4 select commands at Pin 15. All the switching is done internally. The supply voltage should be present at all the VCC pins for normal operation. The internal switching needed to select each of these signals is shown in Table 1.

Electrical and Mechanical Specifications.

Included in this document are Tables 1 through 5 and Figures 1 through 29, which define the electrical and mechanical specifications of the RF250.

Table 1: Mode Control Select Signal Switching

Table 2: Pin Assignments and Functional Pin Descriptions

Table 3: Absolute Maximum Ratings

Table 4: Recommended Operating Conditions

Table 5: Electrical Specifications

Figure 1: Pinout Configuration

Figure 2: Functional Block Diagram

Figures 3 - 27: Typical Functional Block Performances

Figure 28: Package Dimensions

Figure 29: Tape and Reel Dimensions

ESD Sensitivity

The RF250 is a Class 1 device. The following extreme Electrostatic Discharge (ESD) precautions are required according to the Human Body Model (HBM):

- Protective outer garments.
- Handle device in ESD safeguarded work area.
- Transport device in ESD shielded containers.
- Monitor and test all ESD protection equipment.

The HBM ESD withstand threshold value, with respect to ground, is ± 1.5 kV. The HBM ESD withstand threshold value, with respect to VDD (the positive power supply terminal) is also ± 1.5 kV.

Pin	AMPS	CDMA	PCS
7 (CELL/PCS)	0	0	1
8 (FM/CDMA)	0	1	x
15 (DIV2/DIV4)	0	0	0
23 (SLEEP)	1	1	1
Key: 0 = LOW 1 = HIGH x = N/A			

Table 1. Mode Control Select Signal Switching

Table 2. RF250 Signal Description (1 of 2)

Pin #	Name	Description
1	GND	Ground
2	CELL_LNA_DECOUPLE	An RF bypass capacitor with very short trace should be connected to this pin.
3	NC	No connection
4	CELL_LNA_IN	The input to LNA needs external matching. The matching network should be placed as close to this pin as possible. High Q components are recommended to minimize the effect on the noise figure.
5	VCC1	Supply voltage to the RF bias. An RF bypass capacitor should be connected from the pin to ground with short traces..
6	CELL_BIAS_SET	This pin sets the cellular RF bias current. Typically, a 180 Ω resistor is connected from the pin to ground.
7	CELL/PCS	Band select: 0 = cellular (800 MHz); 1 = PCS (1900 MHz).
8	FM/CDMA	Cellular band mode select: 0 = AMPS; 1 = CDMA.
9	VCC2	Voltage supply pin to the VCO buffer. A bypass capacitor should be placed close to the device from pin 9 to pin 10. The trace should be short and connected immediately to the ground plane for best performance.
10	GND	Ground return from the VCO buffer.
11	CELL_TANK-	Differential tank connection for the cellular band VCO. Care should be taken during the layout of the external tank circuit to prevent parasitic oscillations.
12	CELL_TANK+	Differential tank connection for the cellular band VCO. Care should be taken during the layout of the external tank circuit to prevent parasitic oscillations.
13	PCS_TANK-	Differential tank connection for the PCS band VCO. Care should be taken during the layout of the external tank circuit to prevent parasitic oscillations.
14	PCS_TANK+	Differential tank connection for the PCS band VCO. Care should be taken during the layout of the external tank circuit to prevent parasitic oscillations.
15	DIV2/DIV4	Selects the divide ratio of the VCO to the LO port of the I/Q demodulator: 0 = divide by 2, 1 = divide by 4.
16	PLL+	Differential buffered VCO output.
17	PLL-	Differential buffered VCO output.
18	GND	Ground
19	I-	I channel differential output.
20	I+	I channel differential output.
21	Q+	Q channel differential output.
22	Q-	Q channel differential output.
23	SLEEP	Activates sleep mode: 0 = sleep; 1 = enable
24	VGA_CONTROL	VGA voltage input. Input impedance is greater than 50K Ω .
25	VCC3	Voltage supply to VGA and I/Q demodulator stages. Supply should be well regulated and bypassed to prevent modulation of the signal by the supply ripple.
26	VGA_CDMA_IN-	CDMA differential VGA input
27	VGA_CDMA_IN+	CDMA differential VGA input
28	VGA_AMPS_IN	AMPS VGA input.

Table 2. RF250 Signal Description (2 of 2)

Pin #	Name	Description
29	VGA_PCS_IN-	PCS differential VGA input.
30	VGA_PCS_IN+	PCS differential VGA input.
31	CELL_MIX_BYPASS	Low frequency bypass for the AMPS mixer.
32	CDMA_IF_OUT-	CDMA differential mixer output. Requires an external inductor to VCC. Output impedance is set by an external match.
33	CDMA_IF_OUT+	CDMA differential mixer output. Requires an external inductor to VCC. Output impedance is set by an external match.
34	AMPS_IF_OUT	AMPS mixer output. Requires an external inductor to VCC. Output impedance is set by an external match.
35	PCS_IF_OUT-	PCS differential mixer output. Requires an external inductor to VCC. Output impedance is set by an external match.
36	PCS_IF_OUT+	PCS differential mixer output. Requires an external inductor to VCC. Output impedance is set by an external match.
37	PCS_MIX_BYPASS	Low frequency bypass for the PCS mixer.
38	PCS_LO	The local oscillator input for the PCS band.
39	CELL_LO	The local oscillator input for the cellular band.
40	PCS_MIX_IN	PCS mixer input.
41	VCC4	Voltage supply pin for the mixers. An RF bypass capacitor should be connected from this pin to ground. It should be connected as close to the device as possible with very short trace lengths.
42	CELL_MIX_IN	Cellular mixer input.
43	CELL_IFTRAP	The parallel LC circuit is tuned to the cellular IF frequency.
44	CELL_MIX_GND	Add inductance from the pin to ground to lower mixer gain and increase IIP3.
45	NC	No connection
46	PCS_BIAS_SET	This pin sets the PCS RF bias current. Typically, a 180 Ω resistor is connected from the pin to ground.
47	GND	Ground
48	CELL_LNA_OUT	Cellular band LNA output. This is an open collector output. An inductor must be connected to VCC. The matching is done externally to the chip.

Table 3. Absolute Maximum Ratings

Parameter	Minimum	Maximum	Units
Supply voltage (VCC)	-0.3	+5.5	V
Input voltage range	-0.3	VCC	V
LNA input power	--	+5	dBm
Power dissipation	--	600	mW
Ambient operating temperature	-30	+80	°C
Storage temperature	-40	+125	°C

Table 4. Recommended Operating Conditions

Parameter	Min	Typical	Max	Units
Supply voltage (VCC)	2.7	3.3	3.6	V
Operating temperature	-30	+25	+80	°C
Impedance of logic inputs		50		K Ω
Logic 0	0.0		0.5	V
Logic 1	VCC - 0.5		VCC	V

Table 5. RF250 Rx ASIC Electrical Specifications (1 of 3)

TA = 25° C, VCC = 3.3 V, PLO = -10 dBm

Parameter	Symbol	Test Condition	Min	Typical	Max	Units
Cellular LNA						
Gain @ 881 MHz				13		dB
Gain variation over band (869-894 MHz)					0.5	dB
Gain variation over temperature					1.5	dB
Noise figure @ 881 MHz				2.0		dB
Reverse isolation				20		dB
P1dB @ input				-5		dBm
IP3 @ input				8		dBm
Input return loss (869-894 MHz)					-12	dB
Output return loss (869-894 MHz)				-15		dB
Total supply current (adjustable)				12		mA
Cellular Mixer						
Conversion gain (power): CDMA mode AMPS mode				14 11		dB dB
Single-sideband noise figure: CDMA mode AMPS mode				7.5 8		dB dB
P1dB @ input: CDMA mode AMPS mode				-6 -9		dBm dBm
IP3 @ input: CDMA mode AMPS mode				5 3		dBm dBm
Mixer RF input return loss, RF port 1 (869-894 MHz)				-15		dB
LO input power level				-10		dBm
IF output resistance: CDMA mode (differential) AMPS mode (single-ended)				3000 1000		Ω Ω
IF frequency range					300	MHz
LO/RF input isolation				20		dB
Total supply current				18		mA

Table 5. RF250 Rx ASIC Electrical Specifications (2 of 3)

TA = 25° C, VCC = 3.3 V, PLO = -10 dBm

Parameter	Symbol	Test Condition	Min	Typical	Max	Units
PCS Mixer						
Conversion gain (power)				10		dB
Single-sideband noise figure				12		dB
P1dB @ input				-5		dBm
IP3 @ input				5		dBm
RF input return loss (1930-1990 MHz)				-15		dB
LO input power level				-10		dBm
IF output resistance (differential)				1000		Ω
IF frequency range					300	MHz
LO/LNA input isolation			25			dB
LO/RF input isolation				20		dB
Total supply current (adjustable)				24		mA
Rx VGA - I/Q Demodulator						
Frequency range			50		300	MHz
Input impedance: CDMA input (differential) PCS input (differential) AMPS input (single-ended)				1000 1000 1000		Ω Ω Ω
Gain: Maximum Minimum Maximum (AMPS) Minimum (AMPS)			53 -47 61 -39	54 -42 62 -34	55 -37 63 -29	dB dB dB dB
Gain slope				45		dB/V
Gain slope linearity (over any 6 dB segment)			-3		+3	dB
IF amplifier IIP3: @ Maximum gain (CDMA and PCS mode) @ maximum gain (AMPS mode)				-50 -58		dBm
Input 1 dB compression @ minimum gain				-10		dBm
IF amplifier noise figure: @ Maximum gain Minimum gain				5 50		dB dB

Table 5. RF250 Rx ASIC Electrical Specifications (3 of 3)

TA = 25° C, VCC = 3.3 V, PLO = -10 dBm

Parameter	Symbol	Test Condition	Min	Typical	Max	Units
Rx VGA - I/Q Demodulator (continued)						
Output level: CDMA AMPS				2.75 5.5		mVrms mVrms
Maximum output level			1.4			Vp-p
Gain variation over frequency: CDMA (1-630 kHz) AMPS (0.1-12.2 kHz)				0.1 0.1	0.3 0.3	dB dB
Output impedance (differential)			500			
I+, I-, and Q+, Q- DC offset					6	mVrms
I/Q gain mismatch				0.2	0.3	dB
I/Q phase mismatch				2	4	deg
I to Q DC offset					30	mV
Total supply current (includes I/Q mixers, LO buffers, and dividers)				15		mA
Oscillator						
Frequency range			100		640	MHz
Phase noise (fc = 200 MHz, unloaded Q = 20) @ 100 kHz offset				-117		dBc/Hz
Second harmonic distortion (application dependent)				-30	-26	dBc
Output level to PLL (differential)				300		mVp-p
Output impedance to PLL (differential)				300		Ω
Reverse isolation			-30		-40	dB
Total supply current				5		mA

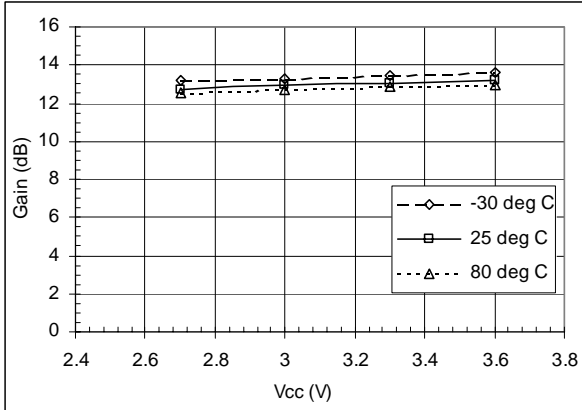

Figure 3. LNA Gain Over Temperature at 881.52 MHz

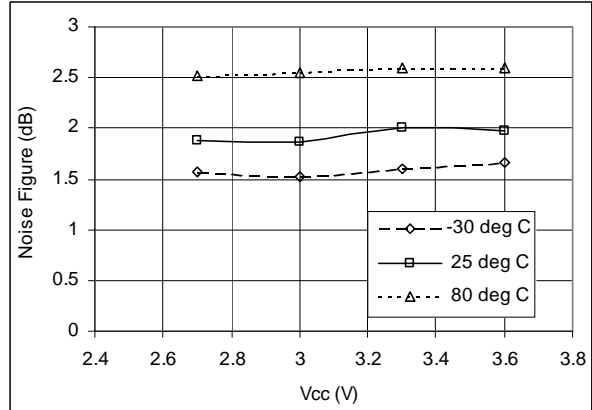

Figure 4. LNA Noise Figure at 881.52 MHz

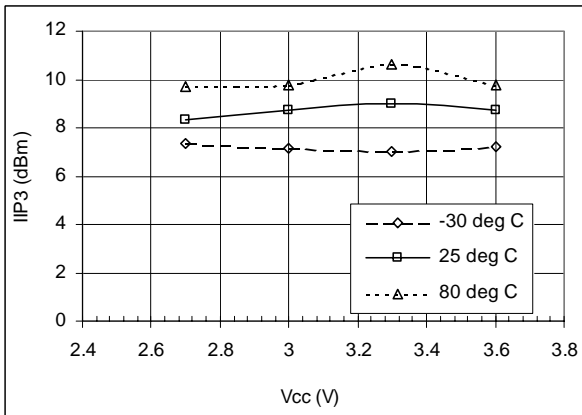

Figure 5. LNA IIP3 at 881.52 MHz

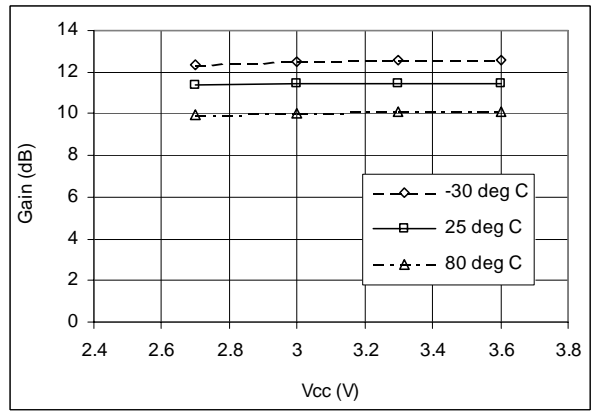

Figure 6. AMPS Mixer Gain
(RF Frequency = 881.52 MHz, LO Frequency = 966.90 MHz, IF Frequency = 85.38 MHz)

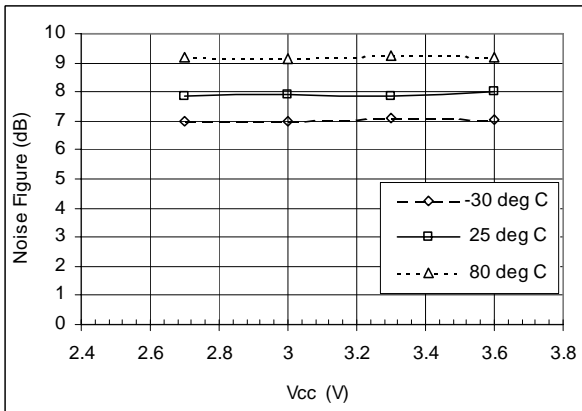

Figure 7. AMPS Mixer Noise Figure
(RF Frequency = 881.52 MHz, LO Frequency = 966.90 MHz, IF Frequency = 85.38 MHz)

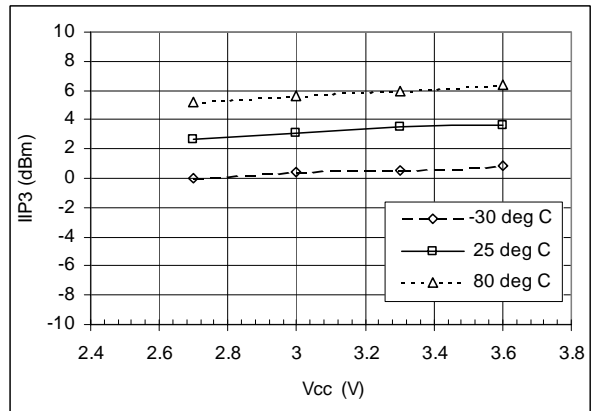

Figure 8. IIP3 of AMPS Mixer
(RF Frequency = 881.52 MHz, LO Frequency = 966.90 MHz, IF Frequency = 85.38 MHz)

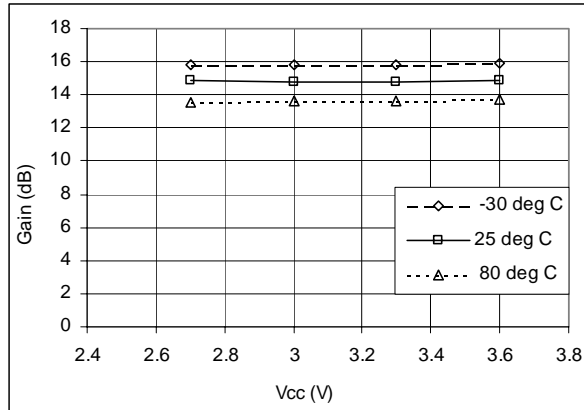

Figure 9. CDMA Mixer Gain
(RF Frequency = 881.52 MHz, LO Frequency = 966.90 MHz, IF Frequency = 85.38 MHz)

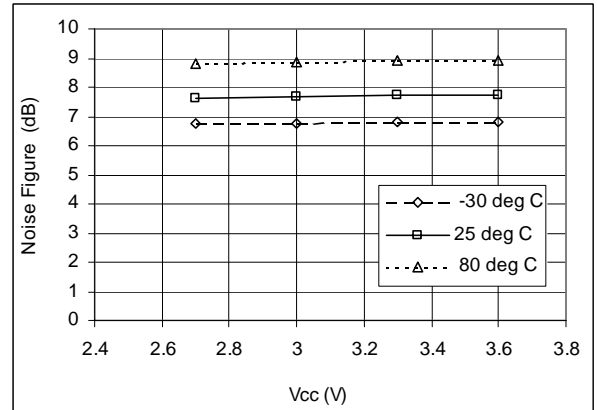

Figure 10. CDMA Mixer Noise Figure
(RF Frequency = 881.52 MHz, LO Frequency = 966.90 MHz, IF Frequency = 85.38 MHz)

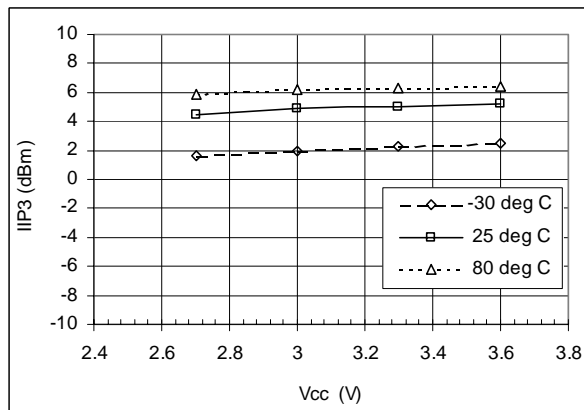

Figure 11. CDMA Mixer IIP3
(RF Frequency = 881.52 MHz, LO Frequency = 966.90 MHz, IF Frequency = 85.38 MHz)

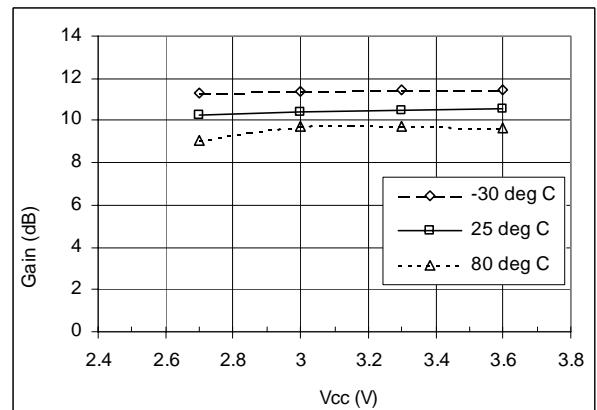

Figure 12. PCS Mixer Conversion Gain
(RF Frequency = 1960 MHz, LO Frequency = 1749.62 MHz, IF Frequency = 210.38 MHz)

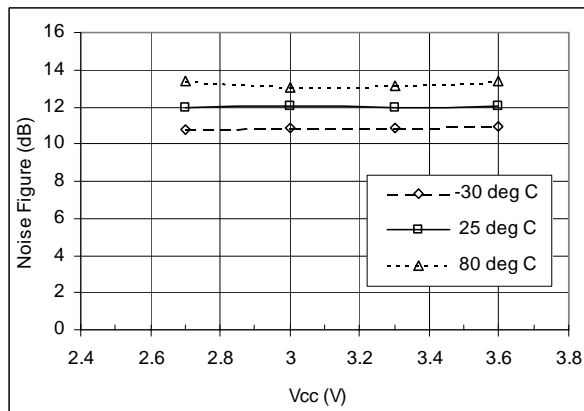

Figure 13. PCS Mixer Noise Figure
(RF Frequency = 1960 MHz, LO Frequency = 1749.62 MHz, IF Frequency = 210.38 MHz)

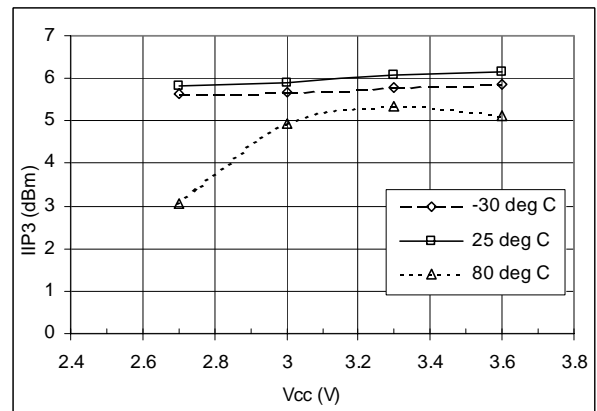

Figure 14. PCS Mixer IIP3
(RF Frequency = 1960 MHz, LO Frequency = 1749.62 MHz, IF Frequency = 210.38 MHz)

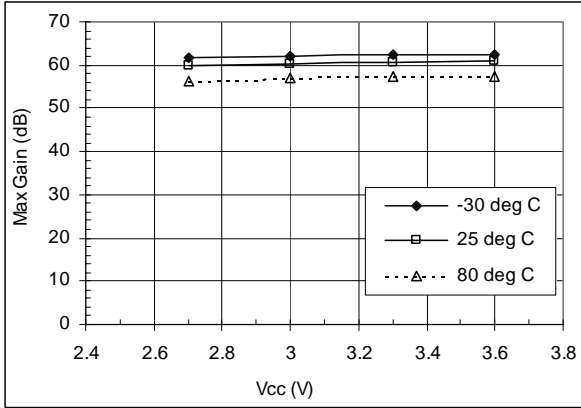

Figure 15. VGA + I/Q Gain in AMPS Mode (Vcontrol = 2.7 V, Frequency = 85.38 MHz)

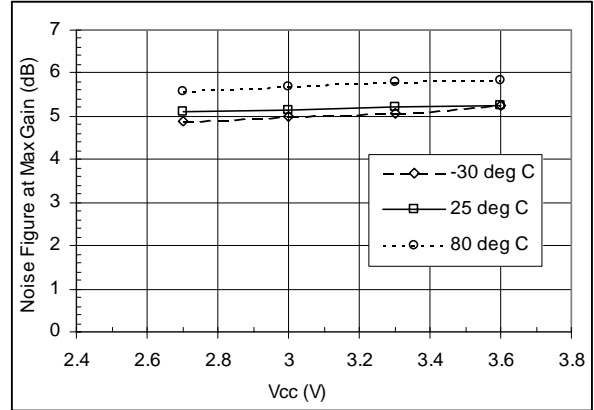

Figure 18. VGA + I/Q Gain in Cellular CDMA Mode (Vcontrol = 2.7 V, Frequency = 85.38 MHz)

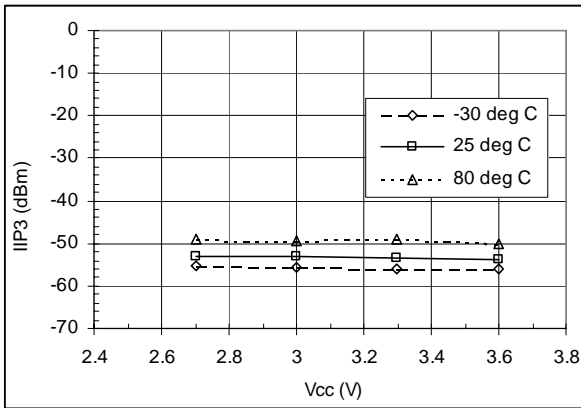

Figure 19. VGA Noise Figure in Cellular CDMA Mode (Vcontrol = 2.7 V, Frequency = 85.38 MHz)

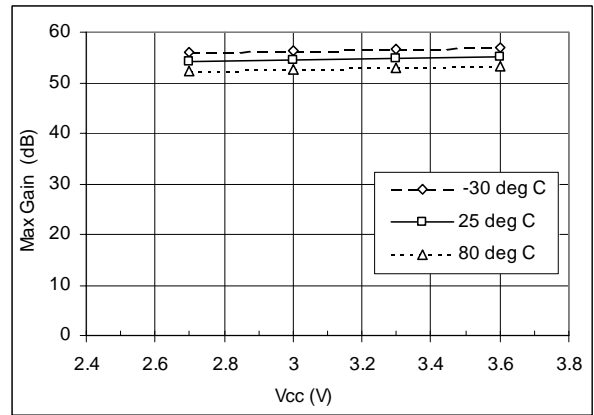

Figure 20. VGA + I/Q IIP3 at Maximum Gain in CDMA Mode

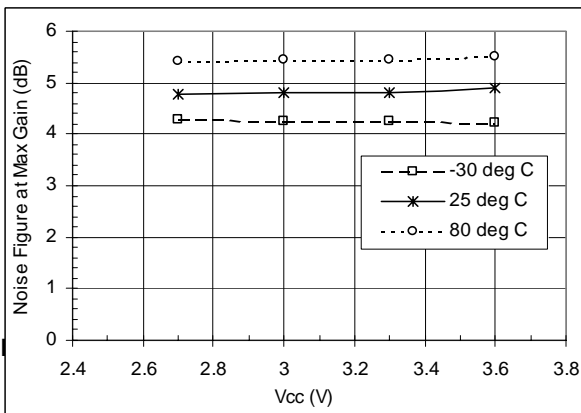

Figure 19. VGA Noise Figure in Cellular CDMA Mode (Vcontrol = 2.7 V, Frequency = 85.38 MHz)

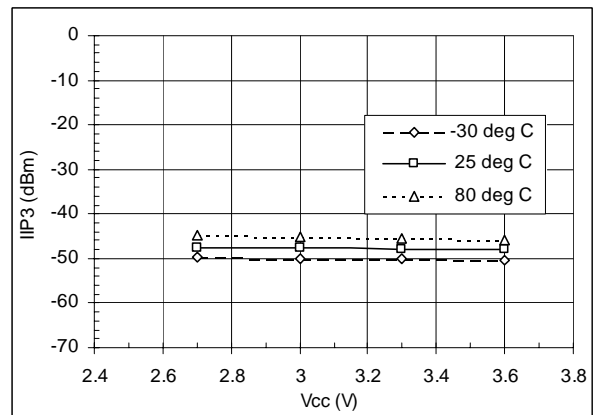

Figure 20. VGA + I/Q IIP3 at Maximum Gain in CDMA Mode

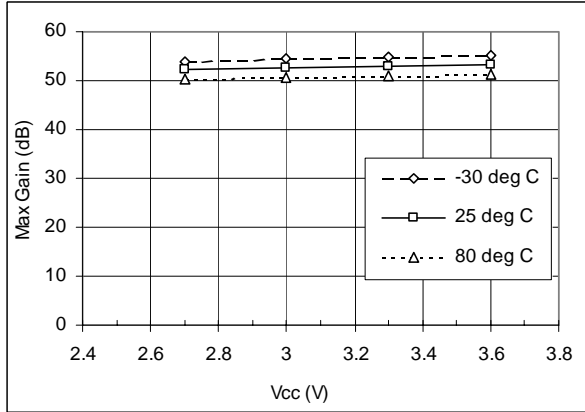

Figure 21. VGA + I/Q Gain in PCS Mode (Vcontrol = 2.7 V, Frequency = 210.38 MHz)

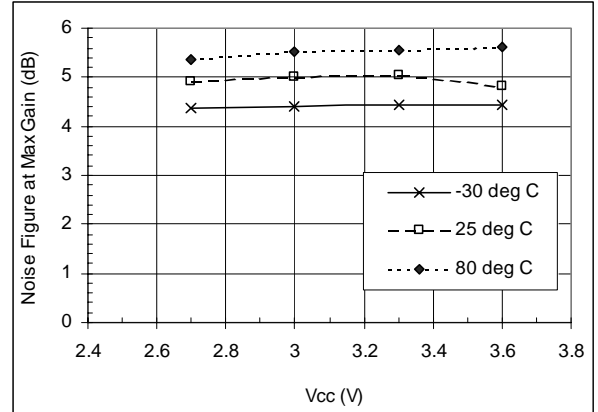

Figure 22. VGA Noise Figure in PCS Mode (Vcontrol = 2.7 V, Frequency = 210.38 MHz)

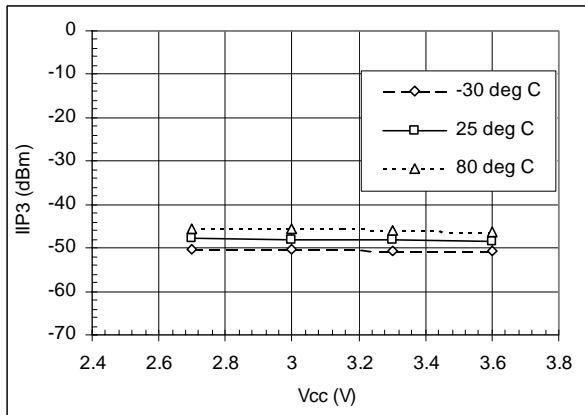

Figure 23. VGA + I/Q IIP3 at Maximum Gain in PCS Mode

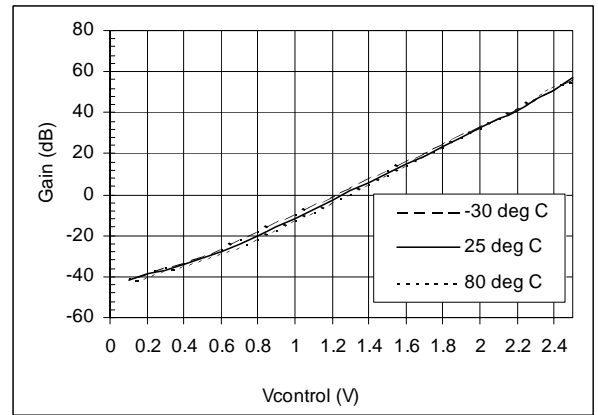

Figure 24. VGA + I/Q Gain Over Temperature (Frequency = 85.38 MHz)

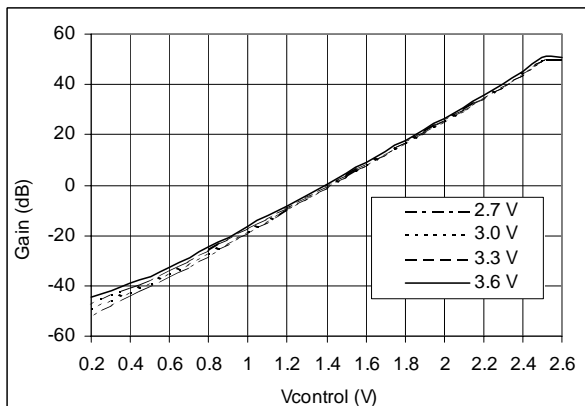

Figure 25. VGA + I/Q Gain vs. Control Voltage in Cellular Mode (Frequency = 85.38 MHz)

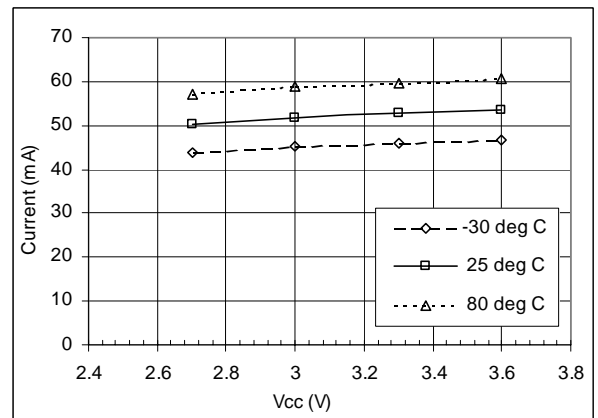

Figure 26. Supply Current in The Cellular Band

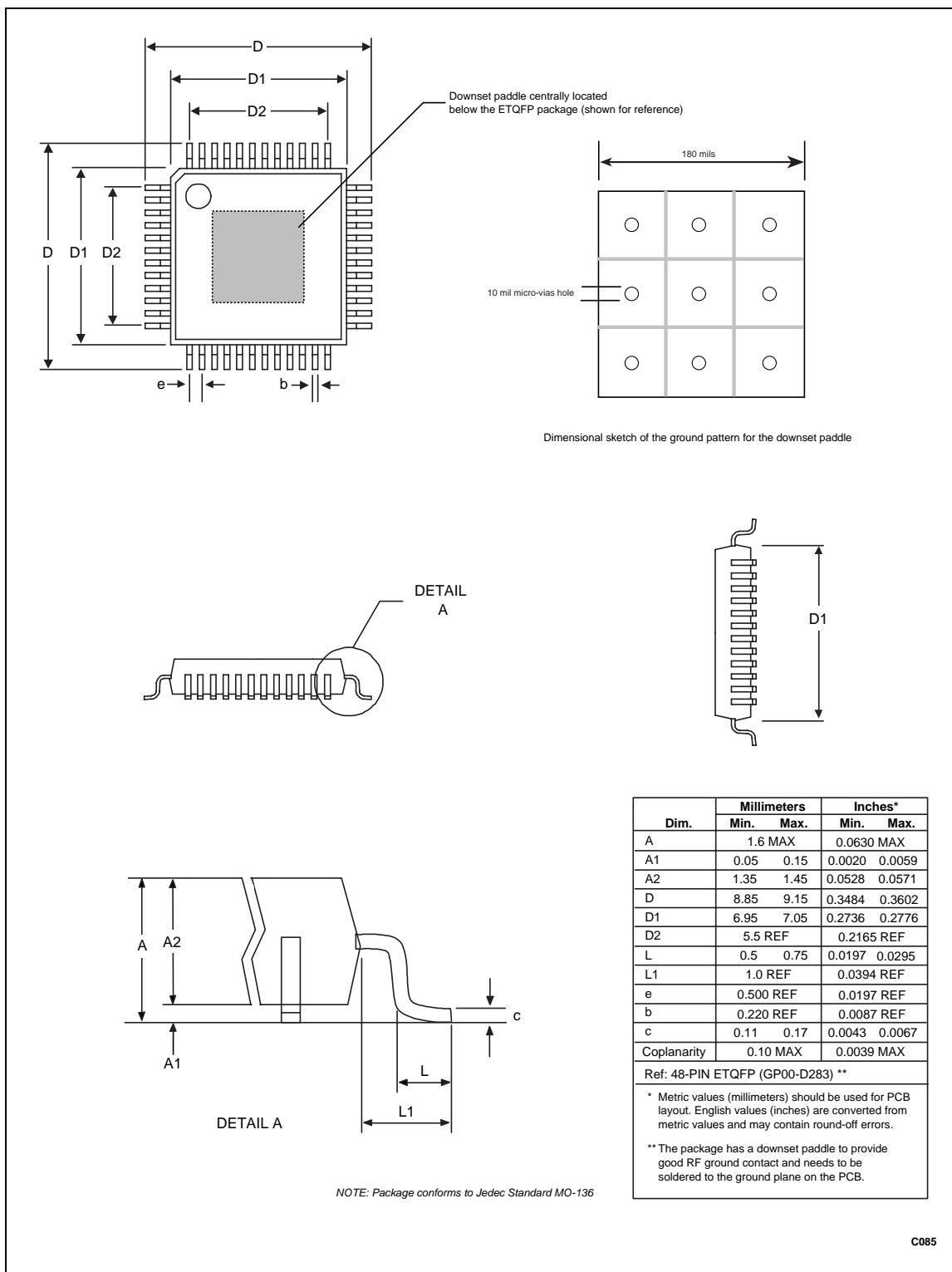

Figure 28. RF250 Rx ASIC Package Dimensions - 48-pin TQFP Package With Downset Paddle

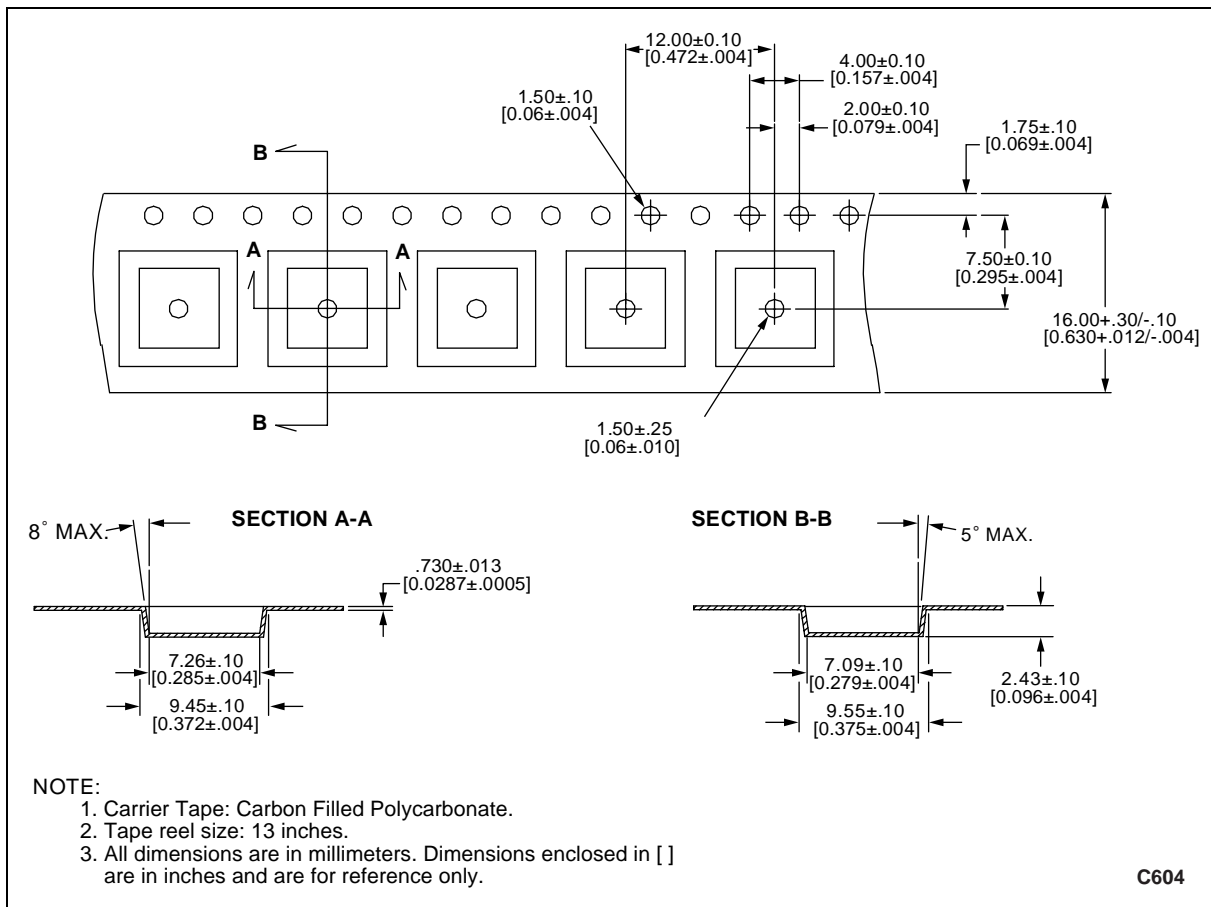

Figure 29. 48-pin TQFP Tape and Reel Dimensions

Ordering Information

Model Name	Manufacturing Part Number	Product Revision
Rx ASIC	RF250-32	

Information provided by Conexant Systems, Inc. Conexant is believed to be accurate and reliable. However, no responsibility is assumed by Conexant for its use, nor any infringement of patents or other rights of third parties which may result from its use. No license is granted by implication or otherwise under any patent rights of Conexant other than for circuitry embodied in Conexant products. Conexant reserves the right to change circuitry at any time without notice. This document is subject to change without notice.

Conexant products are not designed or intended for use in life support appliances, devices, or systems where malfunction of a Conexant product can reasonably be expected to result in personal injury or death. Conexant customers using or selling Conexant products for use in such applications do so at their own risk and agree to fully indemnify Conexant for any damages resulting from such improper use or sale.

Conexant and "What's Next in Communications Technologies" are trademarks of Conexant Systems, Inc.

Product names or services listed in this publication are for identification purposes only, and may be trademarks or registered trademarks of their respective companies. All other marks mentioned herein are the property of their respective holders.

©1999, 2000 Conexant Systems, Inc.

All Rights Reserved



Further Information:
literature@conexant.com
1-800-854-8099 (North America)
33-14-906-3980 (International)

Web Site
www.conexant.com

World Headquarters
Conexant Systems, Inc.
4311 Jamboree Road,
P.O. Box C
Newport Beach, CA 92658-8902
Phone: (949) 483-4600
Fax: (949) 483-6375

U.S. Florida/South America
Phone: (727) 799-8406
Fax: (727) 799-8306

U.S. Los Angeles
Phone: (805) 376-0559
Fax: (805) 376-8180

U.S. Mid-Atlantic
Phone: (215) 244-6784
Fax: (215) 244-9292

U.S. North Central
Phone: (630) 773-3454
Fax: (630) 773-3907

U.S. Northeast
Phone: (978) 692-7660
Fax: (978) 692-8185

U.S. Northwest/Pacific West
Phone: (408) 249-9696
Fax: (408) 249-7113

U.S. South Central
Phone: (972) 733-0723
Fax: (972) 407-0639

U.S. Southeast
Phone: (919) 858-9110
Fax: (919) 858-8669

U.S. Southwest
Phone: (949) 483-9119
Fax: (949) 483-9090

APAC Headquarters
Conexant Systems Singapore,
Pte. Ltd.
1 Kim Seng Promenade
Great World City
#09-01 East Tower
Singapore 237994
Phone: (65) 737 7355
Fax: (65) 737 9077

Australia
Phone: (61 2) 9869 4088
Fax: (61 2) 9869 4077

China
Phone: (86 2) 6361 2515
Fax: (86 2) 6361 2516

Hong Kong
Phone: (852) 2 827 0181
Fax: (852) 2 827 6488

India
Phone: (91 11) 692 4780
Fax: (91 11) 692 4712

Korea - Seoul Office
Phone: (82 2) 565 2880
Fax: (82 2) 565 1440

Korea - Taegu Office
Phone: (82 53) 745-2880
Fax: (82 53) 745-1440

Europe Headquarters
Conexant Systems France
Les Taissounieres B1
1681 Route des Dolines
BP 283
06905 Sophia Antipolis Cedex
France
Phone: (33 4) 93 00 33 35
Fax: (33 4) 93 00 33 03

Europe Central
Phone: (49 89) 829 1320
Fax: (49 89) 834 2734

Europe Mediterranean
Phone: (39 02) 9317 9911
Fax: (39 02) 9317 9913

Europe North
Phone: (44 1344) 486 444
Fax: (44 1344) 486 555

Europe South
Phone: (33 1) 41 44 36 50
Fax: (33 1) 41 44 36 90

Middle East Headquarters
Conexant Systems Commercial
(Israel) Ltd.
P.O. Box 12660
Herzlia 46733
Israel
Phone: (972 9) 952 4064
Fax: (972 9) 951 3924

Japan Headquarters
Conexant Systems Japan Co., Ltd.
Shimomoto Building
1-46-3 Hatsudai,
Shibuya-ku
Tokyo, 151-0061
Japan
Phone: (81 3) 5371 1567
Fax: (81 3) 5371 1501

Taiwan Headquarters
Conexant Systems, Taiwan Co., Ltd.
Room 2808
International Trade Building
333 Keelung Road, Section 1
Taipei 110
Taiwan, ROC
Phone: (886 2) 2720 0282
Fax: (886 2) 2757 6760