

Features

- Low Noise and High Intercept Point
- Adjustable Bias Current
- Power Down Control
- Single 1.8V to 6.0V Power Supply
- 400MHz to 3GHz Operation
- Extremely Small SOT 5-Lead Package

Applications

- WLAN LNA/Driver
- GPS LNA
- CDMA PCS LNA
- Low Noise Transmit Power Amplifier
- General Purpose Amplification
- Driver Amplifier for TX Power Amplifier

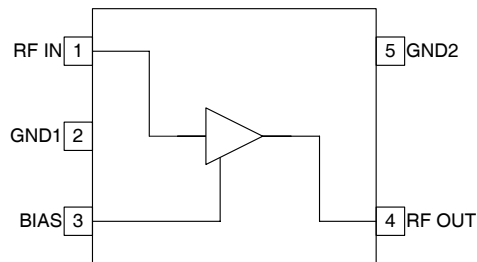

Functional Block Diagram

Product Description

The RF2373 is a low noise amplifier with a very high dynamic range designed for WLAN and digital cellular applications. The device functions as an outstanding front end low noise amplifier or driver amplifier in the transmit chain of digital subscriber units where low transmit noise power is a concern. When used as an LNA, the bias current can be set externally. When used as a PA driver, the IC can operate directly from a single cell Li-ion battery and includes a power down feature that can be used to completely turn off the device. The IC is featured in a standard SOT 5-lead plastic package.

Ordering Information

RF2373PCK-414 Fully Assembled Evaluation Board with 5 Sample Parts

Optimum Technology Matching® Applied

- | | | | |
|--|--------------------------------------|-------------------------------------|-----------------------------------|
| <input checked="" type="checkbox"/> GaAs HBT | <input type="checkbox"/> SiGe BiCMOS | <input type="checkbox"/> GaAs pHEMT | <input type="checkbox"/> GaN HEMT |
| <input type="checkbox"/> GaAs MESFET | <input type="checkbox"/> Si BiCMOS | <input type="checkbox"/> Si CMOS | |
| <input type="checkbox"/> InGaP HBT | <input type="checkbox"/> SiGe HBT | <input type="checkbox"/> Si BJT | |

RF MICRO DEVICES®, RFMD®, Optimum Technology Matching®, Enabling Wireless Connectivity™, PowerStar®, POLARIS™ TOTAL RADIO™ and UltimateBlue™ are trademarks of RFMD, LLC. BLUETOOTH is a trademark owned by Bluetooth SIG, Inc., U.S.A. and licensed for use by RFMD. All other trade names, trademarks and registered trademarks are the property of their respective owners. ©2006, RF Micro Devices, Inc.

Absolute Maximum Ratings

Parameter	Rating	Unit
Supply Voltage	-0.5 to +6.0	V _{DC}
Bias Voltage, V _{BIAS}	≤V _{CC}	V _{DC}
Input RF Level	+15 (see note)	dBm
Current Drain, I _{CC}	32	mA
Operating Ambient Temperature	-40 to +85	°C
Storage Temperature	-40 to +150	°C

NOTE: Exceeding any one or a combination of the above maximum rating limits may cause permanent damage. Input RF transients to +15dBm will not harm the device. For sustained operation at inputs ≥+10dBm, a small dropping resistor of 10Ω is recommended in series with the V_{CC}.



Caution! ESD sensitive device.

Exceeding any one or a combination of the Absolute Maximum Rating conditions may cause permanent damage to the device. Extended application of Absolute Maximum Rating conditions to the device may reduce device reliability. Specified typical performance or functional operation of the device under Absolute Maximum Rating conditions is not implied.

RoHS status based on EU Directive 2002/95/EC (at time of this document revision).

The information in this publication is believed to be accurate and reliable. However, no responsibility is assumed by RF Micro Devices, Inc. ("RFMD") for its use, nor for any infringement of patents, or other rights of third parties, resulting from its use. No license is granted by implication or otherwise under any patent or patent rights of RFMD. RFMD reserves the right to change component circuitry, recommended application circuitry and specifications at any time without prior notice.

Parameter	Specification			Unit	Condition
	Min.	Typ.	Max.		
Overall					25 °C, V _{CC} =3.3V, at typical frequencies unless otherwise specified
Supply Voltage (V _{CC})	2.7	3.3	5.0	V	
Bias Voltage (V _{BIAS})	2.7	3.3	5.0	V	
RF Frequency Range		800 to 2500		MHz	
Power Down Current			10	μA	V _{BIAS} =0V
Isolation		23		dB	
Current Drain (LNA)	8	14	19	mA	
(Driver)	12	18	23	mA	
IP2		55		dBm	
Cellular Low Noise Amplifier					
Frequency	820	880	960	MHz	
Gain	19.5	21.5	23.5	dB	I _{CC} =10mA
Noise Figure		1.1	1.3	dB	
IIP3	-3	-1		dBm	
IP1dB	-13	-11		dBm	
Input VSWR		2.0	2.5		
Output VSWR		4.0	4.5		
GPS Low Noise Amplifier					
Frequency		1575		MHz	
Gain	17.0	19.0	21.0	dB	I _{CC} =10mA
Noise Figure		1.1	1.3	dB	
IIP3	3	5		dBm	
IP1dB	-7	-5		dBm	
Input VSWR		1.7	2.2		
Output VSWR		1.6	2.1		
PCS Low Noise Amplifier					
Frequency Range	1850	1920	1990	MHz	
Gain	16.0	18.0	20.0	dB	I _{CC} =10mA
Noise Figure		1.2	1.4	dB	
IIP3	4	6		dBm	
IP1dB	-7	-5		dBm	

Input VSWR		1.8	2.3		
Output VSWR		1.6	2.1		

Parameter	Specification			Unit	Condition
	Min.	Typ.	Max.		
W-CDMA Low Noise Amplifier					
Frequency Range	1920	2045	2170	MHz	
Gain	15.5	17.5	19.5	dB	$I_{CC} = 10\text{mA}$
Noise Figure		1.2	1.4	dB	
IIP3	6	8		dBm	
IP1dB	-3	-1		dBm	
Input VSWR		1.8	2.3		
Output VSWR		1.6	2.1		
WLAN Low Noise Amplifier					
Frequency	2400	2450	2500	MHz	
Gain	13.0	15.0	17.0	dB	$I_{CC} = 10\text{mA}$
Noise Figure		1.3	1.5	dB	
IIP3	7.5	9.5		dBm	
P1dB	-5.5	-3.5		dBm	
Input VSWR		1.7	2.2		
Output VSWR		1.1	1.6		
Cellular Driver					
Frequency	820	880	960	MHz	
Gain	20.0	22.0	24.0	dB	$I_{CC} = 18\text{mA}$
Noise Figure		1.2	1.4	dB	
OIP3	19	21		dBm	
OP1dB	9	11		dBm	
Input VSWR		2.0	2.5		
Output VSWR		4.0	4.5		
PCS Driver					
Frequency Range	1850	1920	1990	MHz	
Gain	16.5	18.5	20.5	dB	$I_{CC} = 18\text{mA}$
Noise Figure		1.3	1.5	dB	
OIP3	21.5	23.5		dBm	
OP1dB	10.5	12.5		dBm	
Input VSWR		1.8	2.3		
Output VSWR		1.6	2.1		
W-CDMA Driver					
Frequency Range	1920	2045	2170	MHz	
Gain	15.0	17.5	20.0	dB	$I_{CC} = 18\text{mA}$
Noise Figure		1.3	1.5	dB	
OIP3	23.5	25.5		dBm	
OP1dB	14.5	16.5		dBm	
Input VSWR		1.8	2.3		
Output VSWR		1.6	2.1		
WLAN Driver					
Frequency	2400	2450	2500	MHz	
Gain	13.5	15.5	17.5	dB	$I_{CC} = 18\text{mA}$
Noise Figure		1.4	1.6	dB	
OIP3	23	25		dBm	
OP1dB	10	12		dBm	

Input VSWR		1.7	2.2		
Output VSWR		1.1	1.6		

Pin	Function	Description	Interface Schematic
1	RF IN	RF input pin. This pin is DC coupled.	
2	GND1	Ground connection. For best performance, keep traces physically short and connect immediately to ground plane.	
3	BIAS	This pin is used to control the bias current. An external resistor can be used to set the bias current for any V_{BIAS} voltage. See table with evaluation board schematic.	
4	RF OUT	Amplifier output pin. This pin is an open-collector output. It must be biased to V_{CC} through a choke or matching inductor. This pin is typically matched to 50Ω with a shunt bias/matching inductor and series blocking/matching capacitor. Refer to application schematics.	
5	GND2	Ground connection. For best performance, keep traces physically short and connect immediately to ground plane.	

Package Drawing SOT 5-Lead

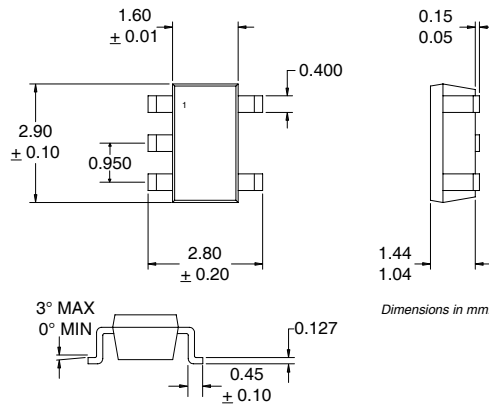

Evaluation Board Schematic

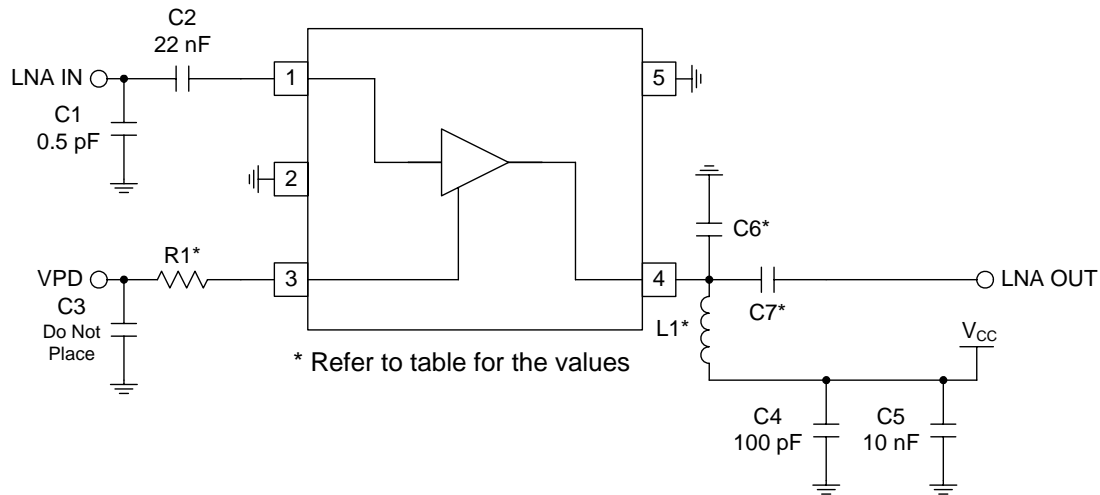

Component	Cellular 900 MHz	GPS 1575 MHz	PCS 1950 MHz	W-CDMA 2140 MHz	WLAN 2450 MHz
L1 (nH)	3.9	2.7	2.7	2.7	2.2
C6 (pF)	4.3	1.5	0.5	DNP	DNP
C7 (pF)	2.0	1.2	1.0	1.0	1.0

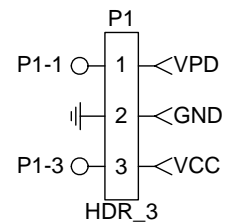

V _{PD}	I _{CC}	I _{CC}	I _{CC}	I _{CC}	I _{CC}
	R1 = 300 Ω	R1 = 430 Ω	R1 = 560 Ω	R1 = 1 kΩ	R1 = 1.5 kΩ
2.7	12	9	7	5	4
3.0	16	12	9	6	5
3.3	20	15	11	7	5
3.6	25	19	14	8	6
4.0	31	24	18	10	7
4.5	Over Limit	31	23	13	8
5.0	Over Limit	Over Limit	29	16	10

Note: V_{CC} set to 3.3 V. I_{CC} only slightly dependent on V_{CC}.

This information pertains to the following charts.
Test condition unless otherwise specified: $V_{CC}=3.3V$, use evaluation board for corresponding frequencies.

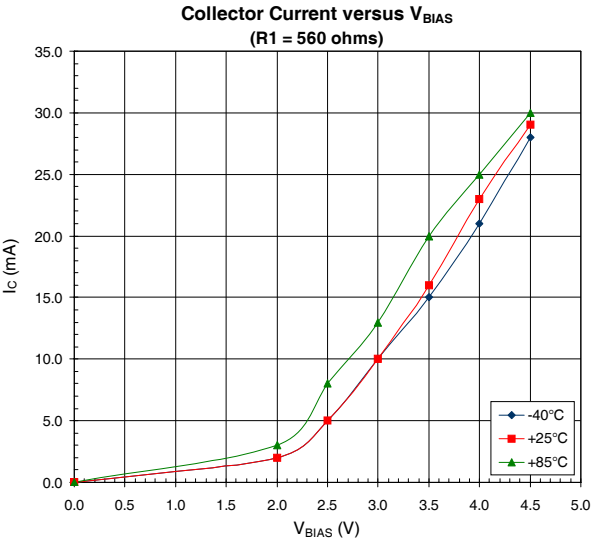

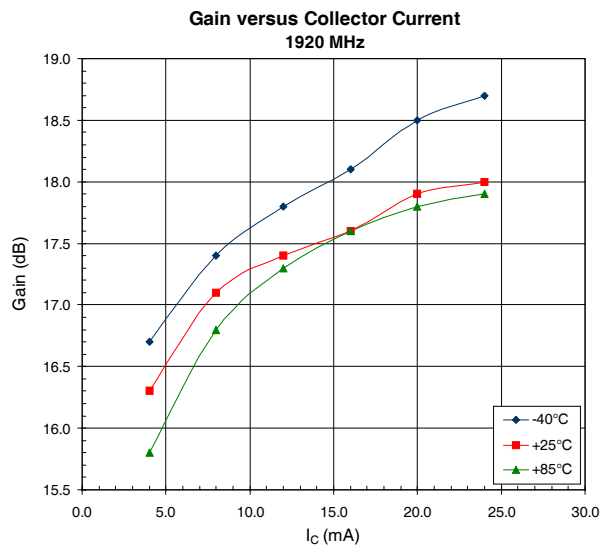
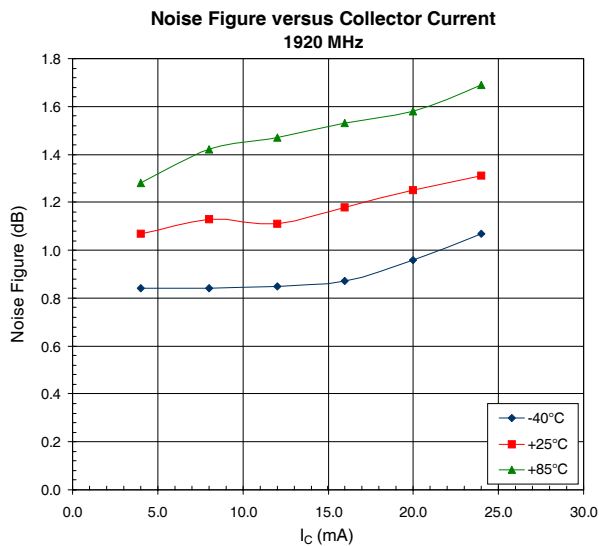
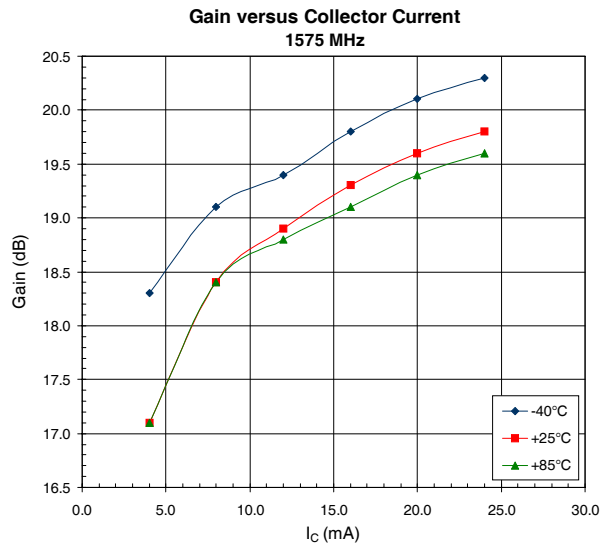
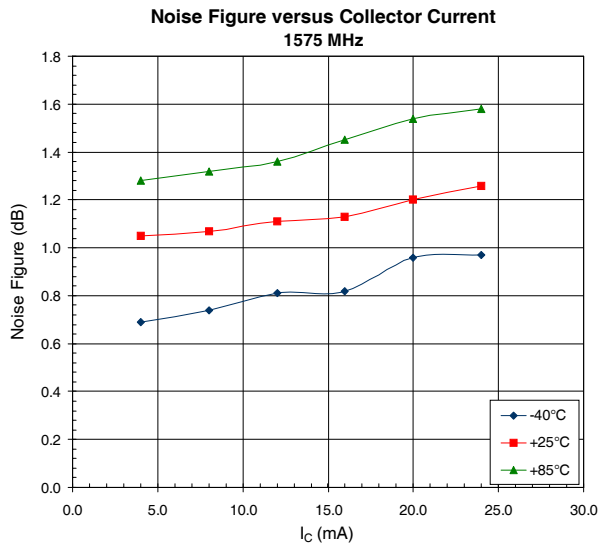
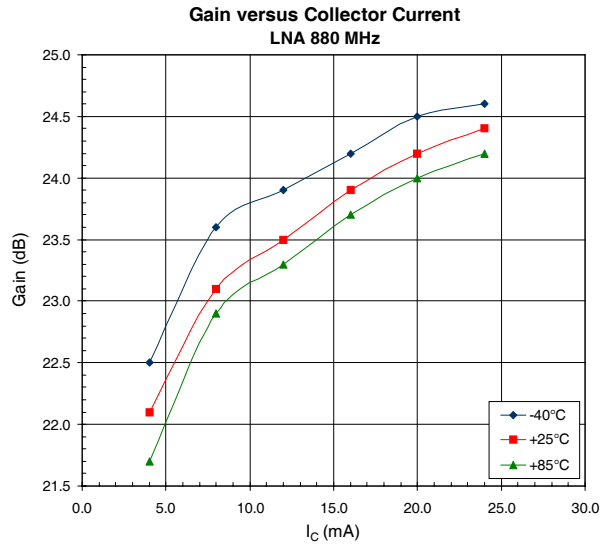
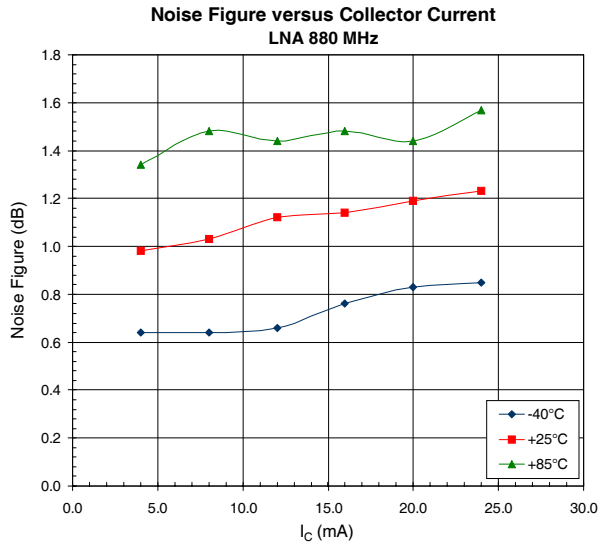

Noise Figure versus Collector Current
2025 MHz

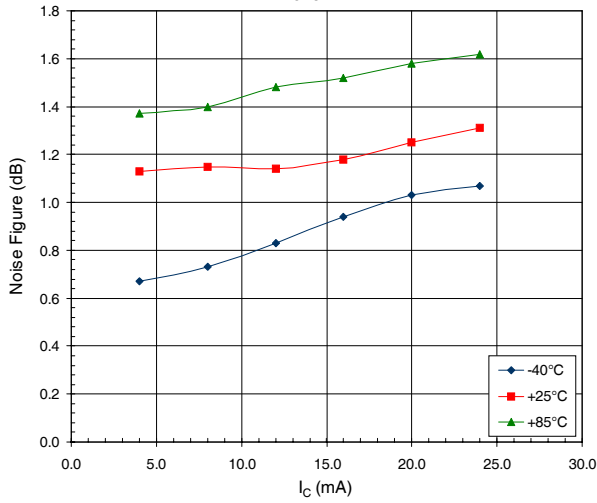

Gain versus Collector Current
2025 MHz

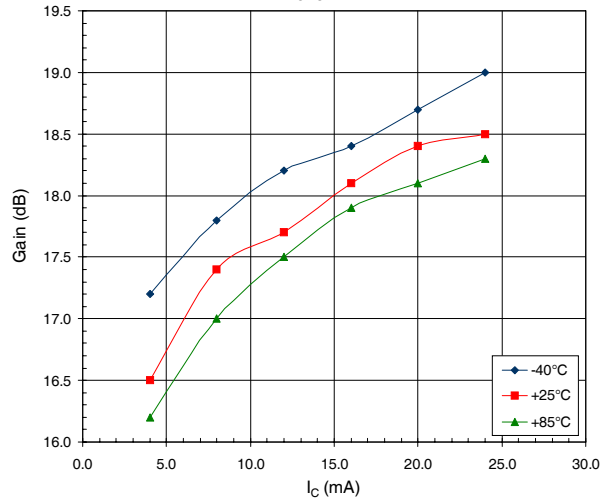

Noise Figure versus Collector Current
2450 MHz

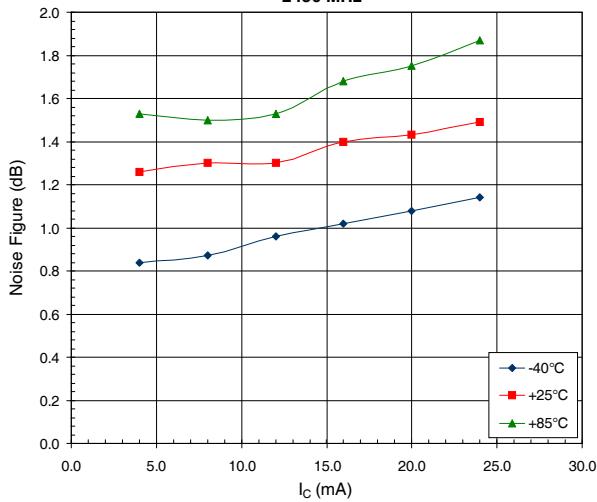

Gain versus Collector Current
2450 MHz

