

RD6R1A Rotary Type

Long-life sensor supporting absolute linearity

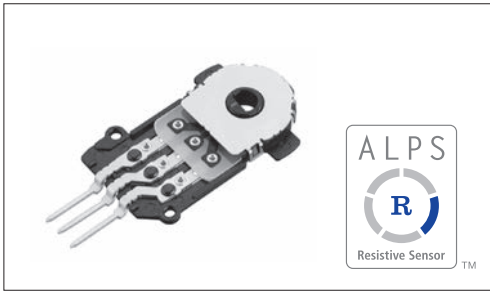

Typical Specifications

Items	Specifications
Rated Voltage	5V DC
Operating life	500,000 cycles
Total resistance	3.8kΩ
Operating temperature range	-40°C to +85°C

Product Line

Mounting method	Linearity guarantee range	Linearity	Hollow shaft variation	Minimum order unit (pcs.)		Model No.
				Japan	Export	
Connector type	310°	±2%	φ3.53	1,800	1,800	RD6R1A0008

Note

Please ask about linearity with variable ranges other than 320° .

Packing Specifications

Tray

Number of packages (pcs.)		Export package measurements (mm)
1 case /Japan	1 case /export packing	
1,800	1,800	540×360×250

Dimensions

Unit:mm

形状

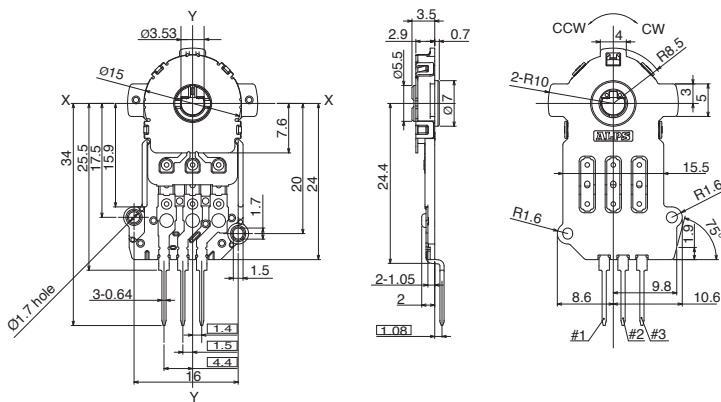

Circuit Diagram

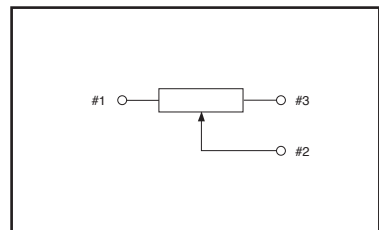

Refer to P.477 for product specifications.

Method for Regulating the Linearity

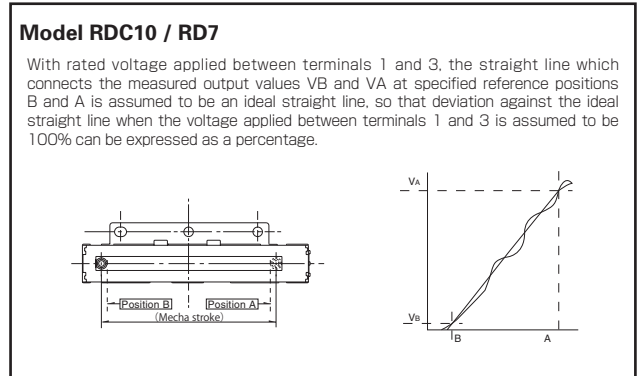
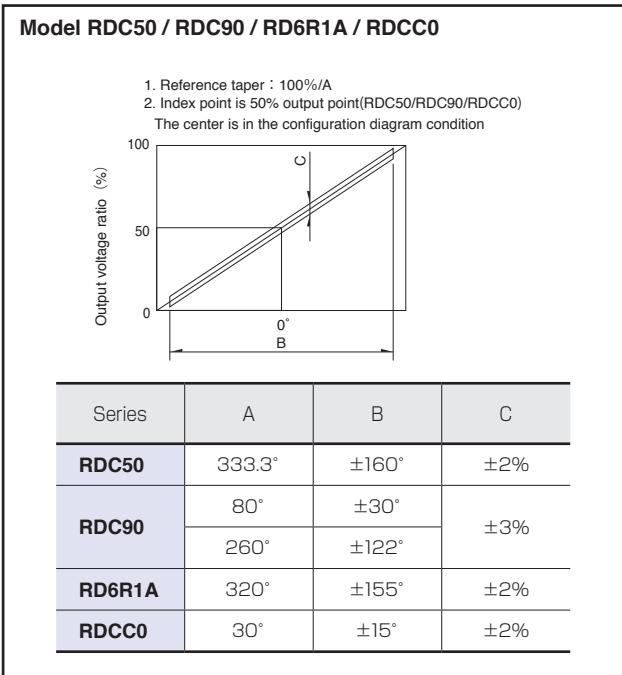
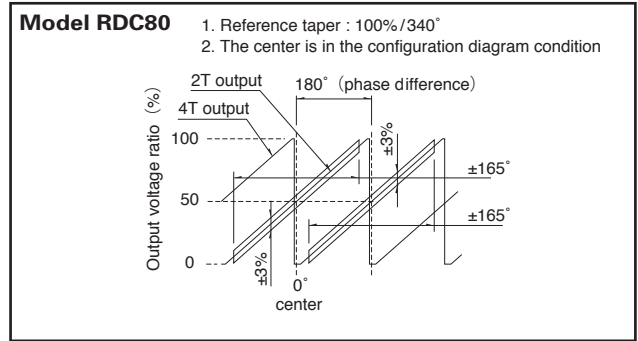
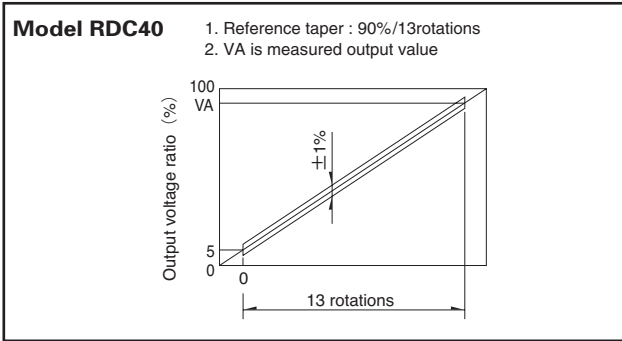

Resistive Position Sensors / Measurement and Test Methods

Resistive Position Sensor

[Total Resistance]

The total resistance, with the shaft (lever) placed at the end of terminal 1 or 3, shall be determined by measuring the resistance between the resistor terminals 1 and 3 unless otherwise specified.

[Rating Voltage]













The rating voltage corresponding to the rated power shall be determined by the following equation. When the resulting rated voltage exceeds the maximum operating voltage of a specific resistor, the maximum operating voltage shall be taken as the rated voltage.

$$E = \sqrt{P \cdot R}$$

E : Rated voltage (V)
 P : Rated power (W)
 R : Total nominal resistance (Ω)

Resistive Position Sensors

List of Varieties

Type	Rotary Type					Magnetic Rotary Type	
Series	RDC40	RDC50	RDC90	RDC80	RD6R1A	RDCC0	
Photo						 NEW	
Direction of lever	Horizontal	Vertical Horizontal	Vertical				
Effective electrical angle (°)	5,400 (15 rotations)	333.3	80,260	340 (1-phase) 360 (2-phase)	320	30	
Linearity guarantee range (°)	4,680 (13 rotations)	320	60,244	330 (1-phase) 360 (2-phase)	310	±15	
Travel	—	—	—	—	—	—	
Operating temperature range	−30°C to +80°C	−40°C to +120°C			−40°C to +85°C	0°C to +50°C	
Operating life	100,000 cycles	1,000,000 cycles	10,000,000 cycles	100,000 cycles	500,000 cycles	10,000,000 cycles	
Available for automotive use	●	●	●	●	●	—	
Life cycle (availability)							
Mechanical performance	Operating force	—	—	—	—	—	
	Rotational torque	1.96mN·m max.	2mN·m max.		10mN·m max.	100mN·m	5mN·m max.
Electrical performance	Total resistance tolerance	±30%				±20%	—
	Linearity (%)	±1	±2	±3		±2 (320°)	±2
	Rated voltage (V DC)	5					
Environmental performance	Cold	−30°C 240h	−40°C 168h			−40°C 240h	
	Dry heat	80°C 240h	120°C 168h			85°C 168h	85°C 240h
	Damp heat	60°C, 90 to 95%RH 240h	60°C, 90 to 95%RH 96h			80°C, 90 to 95%RH 96h	60°C, 90 to 95%RH 240h
Terminal style	Connector	Insertion / Reflow	Reflow		Connector		
Page	466			469	470	471	

Resistive Position Sensors Measurement and Test Methods	477
Resistive Position Sensors Soldering Conditions	478
Resistive Position Sensors Cautions	479

Note

- Indicates applicability to all products in the series.

Reference for Manual Soldering

Series	Tip temperature	Soldering time
RDC50, RDC90, RDC80	350±5°C	3 ⁺¹ ₀ s
RDC10, RD7	350°C max.	3s max.

Reference for Dip Soldering

Series	Preheating		Dip soldering		No. of solders
	Soldering surface temperature	Heating time	Soldering temperature	Soldering time	
RDC501, RDC502	100 to 150°C	1minute max.	260±5°C	10±1s	1 time
RD7	100°C max.	1minute max.	260°C max.	5s max.	1 time

Example of Reflow Soldering Condition

1. Cleaning Cleaning should not be attempted.
2. Type of solder to be used Use cream solder that contains 10 to 15 %wt flux.
3. Number of solder applications - apply solder only once
4. Recommended reflow conditions

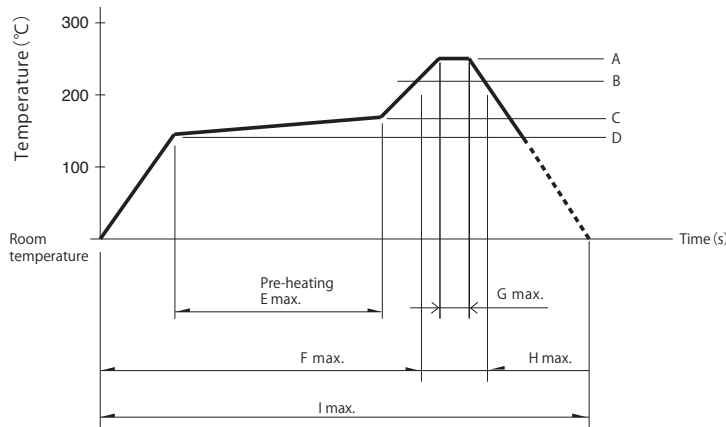

Series	A	B	C	D	E	F	G	H	I	No. of reflows
RDC503 RDC506	250°C	230°C	180°C	150°C	2min.	—	5s	40s	4min.	1 time
RDC90	255°C	230°C	—	—	—	2min.	10s	1min.	4min.	1 time
RDC80	250°C	—	180°C	150°C	90±30s	—	10±1s	—	—	1 time

Notes

1. When using an infrared reflow oven, solder may not always be applied as intended. Be sure to use a hot air reflow oven or a type that uses infrared rays in combination with hot air.
2. The temperatures given above are the maximum temperatures at the terminals of the sensor when employing a hot air reflow method. The temperature of the PC board and the surface temperature of the sensor may vary greatly depending on the PC board material, its size and thickness. Ensure that the surface temperature of the sensor does not rise to 250°C or greater.
3. Conditions vary to some extent depending on the type of reflow bath used. Be sure to give due consideration to this prior to use.