

# RD74LVC1G98

## Configurable Multiple-Function Gate

REJ03D0730-0100

Rev.1.00

Jul 26, 2006

### Description

The RD74LVC1G98 has configurable multiple-function gate in a 6-pin package. The Output state is determined by eight patterns of 3-bit input. The user can choose the logic functions AND, NAND, OR, NOR, INVERTER, Non-Inverted Buffer, Data Selector. Low voltage and high-speed operation is suitable for the battery powered products (e.g., notebook computers), and the low power consumption extends the battery life.

### Features

- The basic gate function is lined up as Renesas uni logic series.
- Supply voltage range: 1.65 to 5.5 V
- Operating temperature range: -40 to +85°C
- All inputs  $V_{IH}$  (Max.) = 5.5 V (@  $V_{CC}$  = 0 V to 5.5 V)
- All outputs  $V_O$  (Max.) = 5.5 V (@  $V_{CC}$  = 0 V)
- Output current:
  - ±4 mA (@  $V_{CC}$  = 1.65 V)
  - ±8 mA (@  $V_{CC}$  = 2.3 V)
  - ±24 mA (@  $V_{CC}$  = 3.0 V)
  - ±32 mA (@  $V_{CC}$  = 4.5 V)
- All the logical input has hysteresis voltage for the slow transition.
- Ordering Information

Part Name	Package Type	Package Code (Previous Code)	Package Abbreviation	Taping Abbreviation (Quantity)
RD74LVC1G98WPE	WCSP-6 pin	SXBG0006LA-A (TBS-6BV)	WP	E (3,000 pcs/reel)

### Article Indication

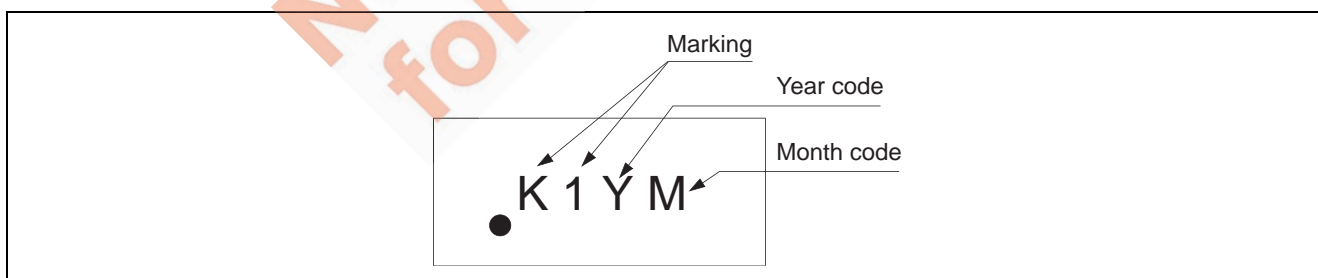

**Function Table**

Inputs			Output
IN2	IN1	IN0	Y
L	L	L	H
L	L	H	H
L	H	L	L
L	H	H	L
H	L	L	H
H	L	H	L
H	H	L	H
H	H	H	L

H: High level  
L: Low level

**Pin Arrangement**

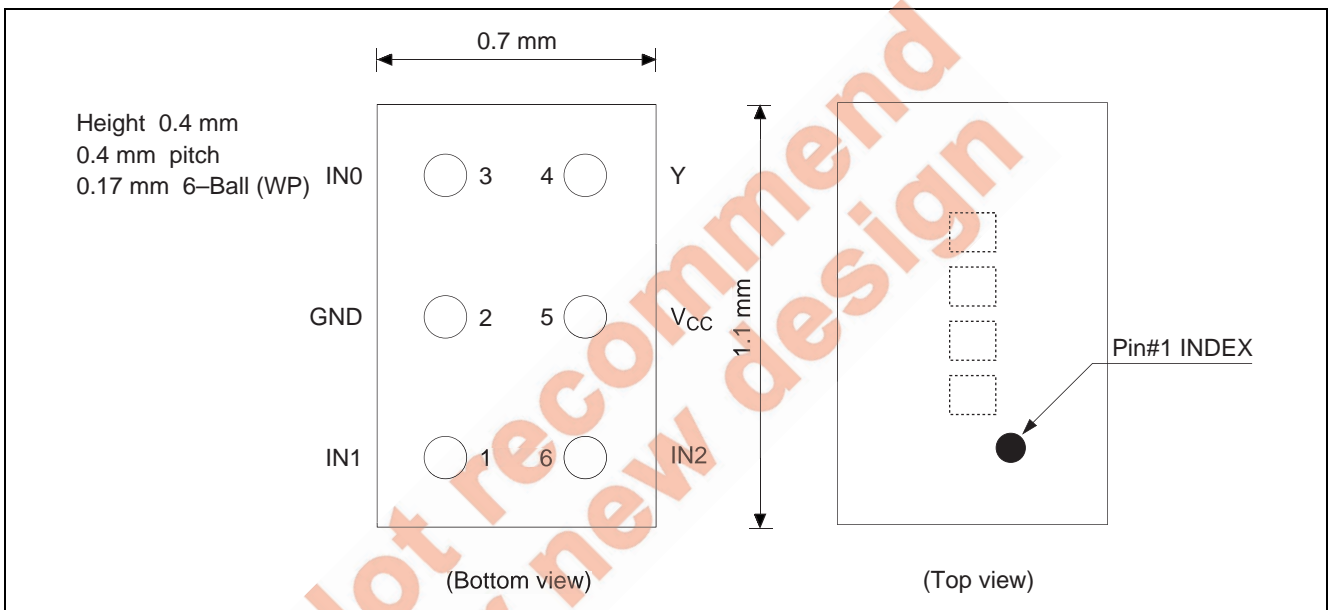

**Logic Diagram**

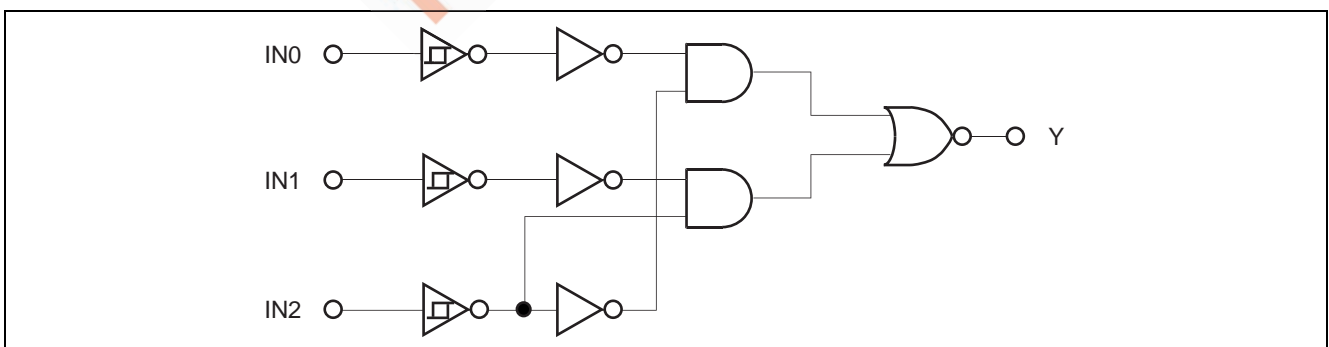

**Function Selection Table**

Logic Function	Figure No.
2 to 1 data Selector	1
2-inputs NAND	2
2-inputs NOR with one input inverted	3
2-inputs AND with one input inverted	3
2-inputs NAND with one input inverted	4
2-inputs OR with one input inverted	4
2-inputs NOR	5
Non-Invert Buffer	6
Inverter	7

Not recommend  
for new design

Logic Configurations

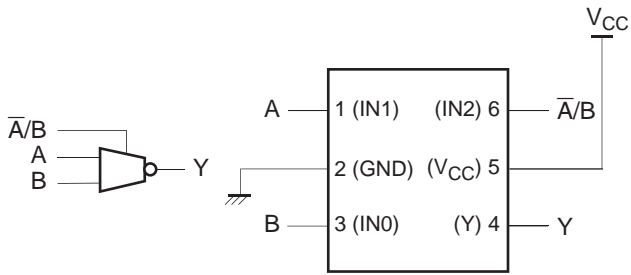

Figure 1 2 to 1 Data Selector

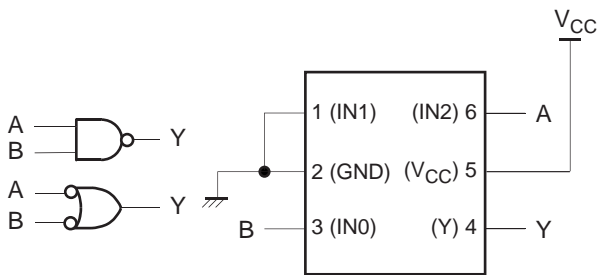

Figure 2 2-inputs NAND Gate

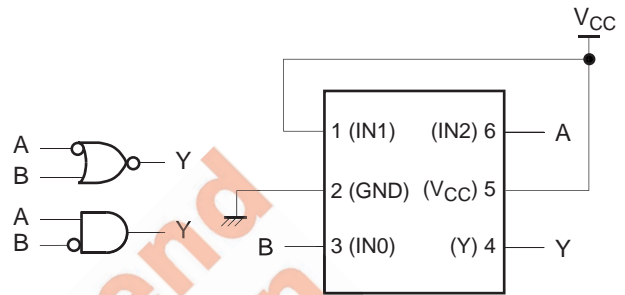

Figure 3 2-inputs NOR Gate with A input inverted

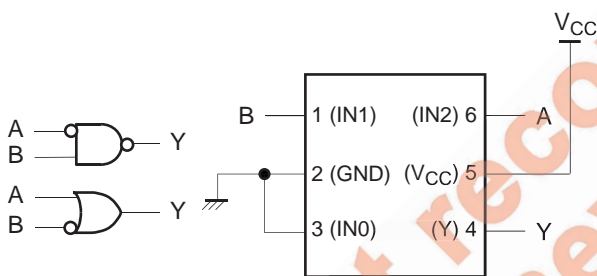

Figure 4 2-inputs NAND Gate with A input inverted

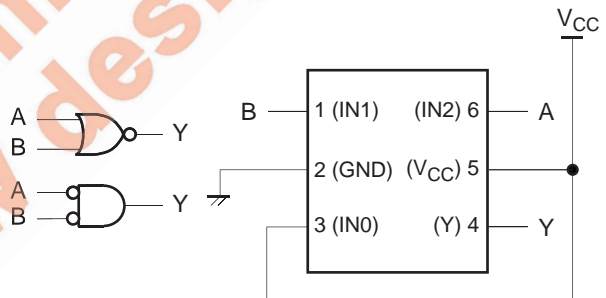

Figure 5 2-inputs NOR Gate

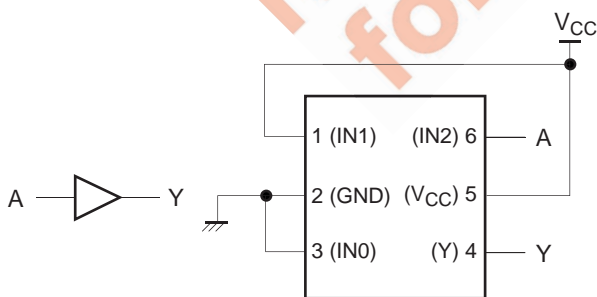

Figure 6 Non-Invert Buffer

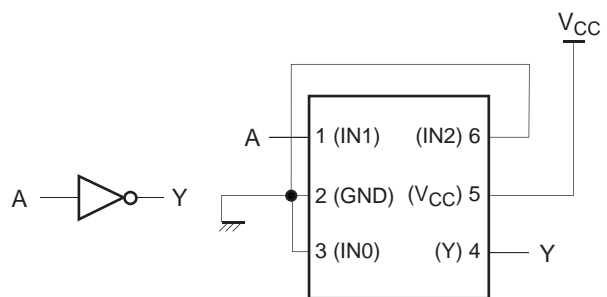

Figure 7 Inverter

## Absolute Maximum Ratings

Item	Symbol	Ratings	Unit	Test Conditions
Supply voltage range	$V_{CC}$	-0.5 to 6.5	V	
Input voltage range <sup>*1</sup>	$V_I$	-0.5 to 6.5	V	
Output voltage range <sup>*1, 2</sup>	$V_O$	-0.5 to $V_{CC} + 0.5$	V	Output : H or L
		-0.5 to 6.5		$V_{CC} : \text{OFF}$
Input clamp current	$I_{IK}$	-50	mA	$V_I < 0$
Output clamp current	$I_{OK}$	-50	mA	$V_O < 0$
Continuous output current	$I_O$	$\pm 50$	mA	$V_O = 0$ to $V_{CC}$
Continuous current through $V_{CC}$ or GND	$I_{CC}$ or $I_{GND}$	$\pm 100$	mA	
Package Thermal impedance	$\theta_{ja}$	123	$^{\circ}\text{C}/\text{W}$	WP
Storage temperature	$T_{stg}$	-65 to 150	$^{\circ}\text{C}$	

Notes: The absolute maximum ratings are values, which must not individually be exceeded, and furthermore no two of which may be realized at the same time.

- The input and output voltage ratings may be exceeded if the input and output clamp-current ratings are observed.
- This value is limited to 5.5 V maximum.

## Recommended Operating Conditions

Item	Symbol	Min	Max	Unit	Conditions
Supply voltage range	$V_{CC}$	1.65	5.5	V	
Input voltage range	$V_I$	0	5.5	V	
Output voltage range	$V_O$	0	$V_{CC}$	V	
Output current	$I_{OL}$	—	4	mA	$V_{CC} = 1.65 \text{ V}$
		—	8		$V_{CC} = 2.3 \text{ V}$
		—	16		$V_{CC} = 3.0 \text{ V}$
		—	24		$V_{CC} = 4.5 \text{ V}$
		—	32		$V_{CC} = 4.5 \text{ V}$
	$I_{OH}$	—	-4		$V_{CC} = 1.65 \text{ V}$
		—	-8		$V_{CC} = 2.3 \text{ V}$
		—	-16		$V_{CC} = 3.0 \text{ V}$
		—	-24		$V_{CC} = 4.5 \text{ V}$
		—	-32		$V_{CC} = 4.5 \text{ V}$
Operating free-air temperature	$T_a$	-40	85	$^{\circ}\text{C}$	

Note: Unused or floating inputs must be held high or low.

## Electrical Characteristics

Ta = -40 to 85°C

Item	Symbol	V <sub>CC</sub> (V)	Min	Typ	Max	Unit	Test condition			
Threshold voltage	V <sub>T</sub> <sup>+</sup>	1.8	0.8	—	1.4	V				
		2.5	1.2	—	1.7					
		3.3	1.6	—	2.3					
		5.0	2.3	—	3.0					
	V <sub>T</sub> <sup>-</sup>	1.8	0.4	—	0.7					
		2.5	0.6	—	1.0					
		3.3	0.9	—	1.4					
		5.0	1.5	—	2.0					
	ΔV <sub>T</sub>	1.8	0.4	—	0.7					
		2.5	0.4	—	0.8					
		3.3	0.4	—	0.9					
		5.0	0.4	—	1.0					
Output voltage	V <sub>OH</sub>	1.65 to 5.5	V <sub>CC</sub> -0.1	—	—	V	I <sub>OH</sub> = -100 μA			
		1.65	1.2	—	—		I <sub>OH</sub> = -4 mA			
		2.3	1.9	—	—		I <sub>OH</sub> = -8 mA			
		3.0	2.4	—	—		I <sub>OH</sub> = -16 mA			
			2.3	—	—		I <sub>OH</sub> = -24 mA			
		4.5	3.8	—	—		I <sub>OH</sub> = -32 mA			
	V <sub>OL</sub>	1.65 to 5.5	—	—	0.1		I <sub>OL</sub> = 100 μA			
		1.65	—	—	0.45		I <sub>OL</sub> = 4 mA			
		2.3	—	—	0.3		I <sub>OL</sub> = 8 mA			
		3.0	—	—	0.4		I <sub>OL</sub> = 16 mA			
			—	—	0.55		I <sub>OL</sub> = 24 mA			
		4.5	—	—	0.55		I <sub>OL</sub> = 32 mA			
		Input current	I <sub>IN</sub>	0 to 5.5	—		—	±5	μA	V <sub>IN</sub> = 5.5 V or GND
		Quiescent supply current	I <sub>CC</sub>	5.5	—		—	10	μA	V <sub>IN</sub> = V <sub>CC</sub> or GND, I <sub>O</sub> = 0
ΔI <sub>CC</sub>	3 to 5.5		—	—	500	One input at V <sub>CC</sub> -0.6 V, Other input at V <sub>CC</sub> or GND				
Output leakage current	I <sub>OFF</sub>	0	—	—	±10	μA	V <sub>IN</sub> or V <sub>O</sub> = 0 to 5.5 V			
Input capacitance	C <sub>IN</sub>	3.3	—	3.5	—	pF	V <sub>IN</sub> = V <sub>CC</sub> or GND			

Note: For conditions shown as Min or Max, use the appropriate values under recommended operating conditions.

## Switching Characteristics

$V_{CC} = 1.8 \pm 0.15 \text{ V}$

Item	Symbol	Ta = -40 to 85°C		Unit	Test Conditions	FROM (Input)	TO (Output)
		Min	Max				
Propagation delay time	$t_{PLH}$ $t_{PHL}$	3.2	14.4	ns	$C_L = 30 \text{ pF}$ , $R_L = 1.0 \text{ k}\Omega$	IN	Y

$V_{CC} = 2.5 \pm 0.2 \text{ V}$

Item	Symbol	Ta = -40 to 85°C		Unit	Test Conditions	FROM (Input)	TO (Output)
		Min	Max				
Propagation delay time	$t_{PLH}$ $t_{PHL}$	2.0	8.3	ns	$C_L = 30 \text{ pF}$ , $R_L = 500 \Omega$	IN	Y

$V_{CC} = 3.3 \pm 0.3 \text{ V}$

Item	Symbol	Ta = -40 to 85°C		Unit	Test Conditions	FROM (Input)	TO (Output)
		Min	Max				
Propagation delay time	$t_{PLH}$ $t_{PHL}$	1.5	6.3	ns	$C_L = 50 \text{ pF}$ , $R_L = 500 \Omega$	IN	Y

$V_{CC} = 5.0 \pm 0.5 \text{ V}$

Item	Symbol	Ta = -40 to 85°C		Unit	Test Conditions	FROM (Input)	TO (Output)
		Min	Max				
Propagation delay time	$t_{PLH}$ $t_{PHL}$	1.1	5.1	ns	$C_L = 50 \text{ pF}$ , $R_L = 500 \Omega$	IN	Y

## Operating Characteristics

Item	Symbol	V <sub>CC</sub> (V)	Ta = 25°C			Unit	Test Conditions
			Min	Typ	Max		
Power dissipation capacitance	C <sub>PD</sub>	1.8	—	23	—	pF	f = 10 MHz
		2.5	—	23	—		
		3.3	—	23	—		
		5.0	—	26	—		

## Test Circuit

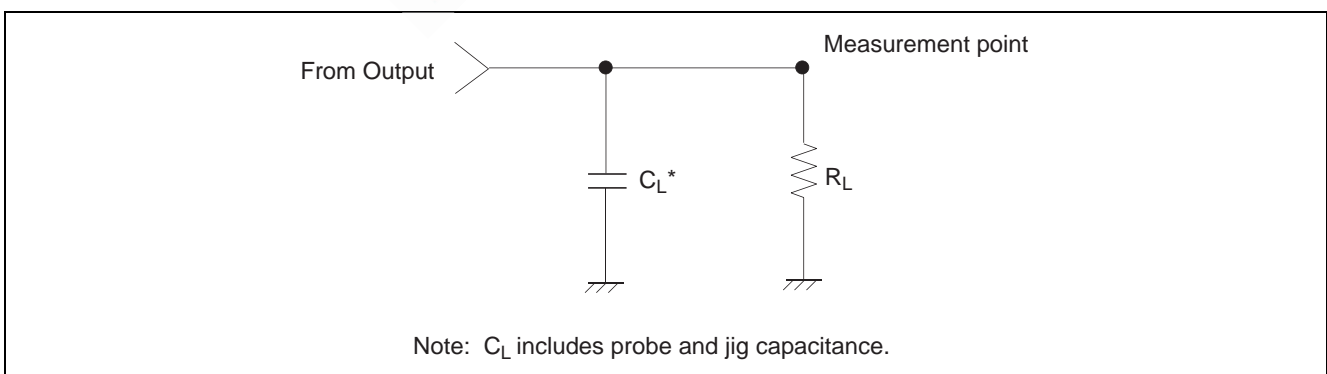

• Waveforms

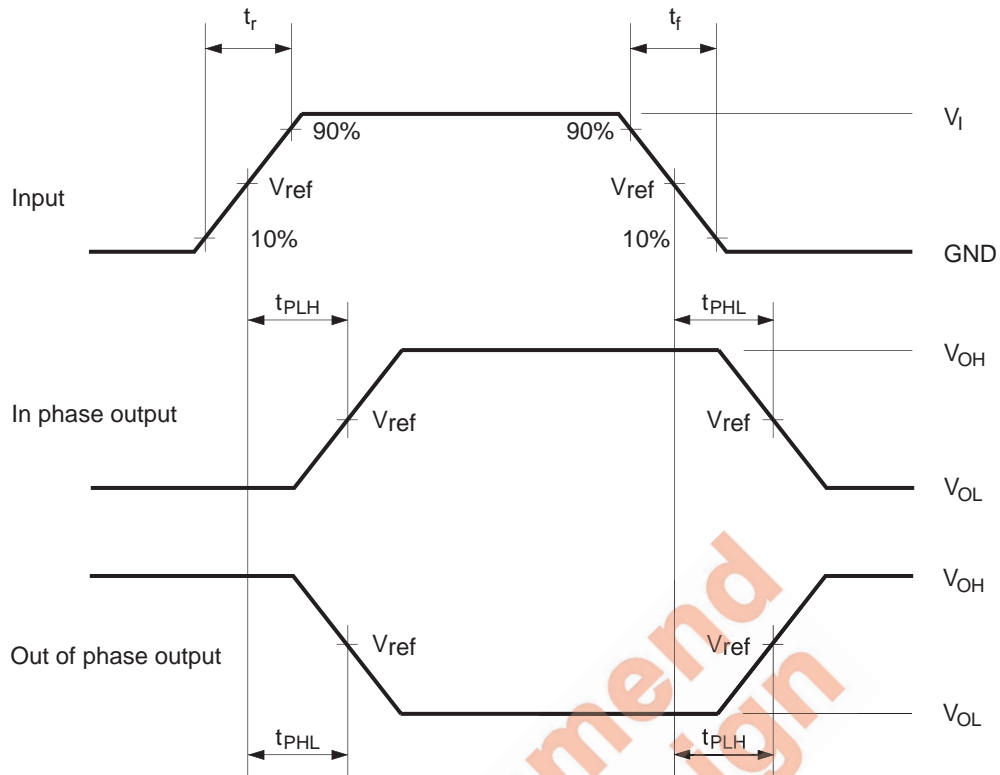

$V_{CC}$ (V)	Inputs		$V_{ref}$	$C_L$	$R_L$
	$V_I$	$t_r / t_f$			
$1.8 \pm 0.15$	$V_{CC}$	$\leq 2$ ns	$V_{CC} / 2$	30 pF	1.0 k $\Omega$
$2.5 \pm 0.2$	$V_{CC}$	$\leq 2$ ns	$V_{CC} / 2$	30 pF	500 $\Omega$
$3.3 \pm 0.3$	3 V	$\leq 2.5$ ns	1.5 V	50 pF	500 $\Omega$
$5.0 \pm 0.5$	$V_{CC}$	$\leq 2.5$ ns	$V_{CC} / 2$	50 pF	500 $\Omega$

- Notes: 1. Input waveform : PRR  $\leq$  10 MHz,  $Z_o = 50 \Omega$ .  
 2. The output are measured one at a time with one transition per measurement.



Package Dimensions

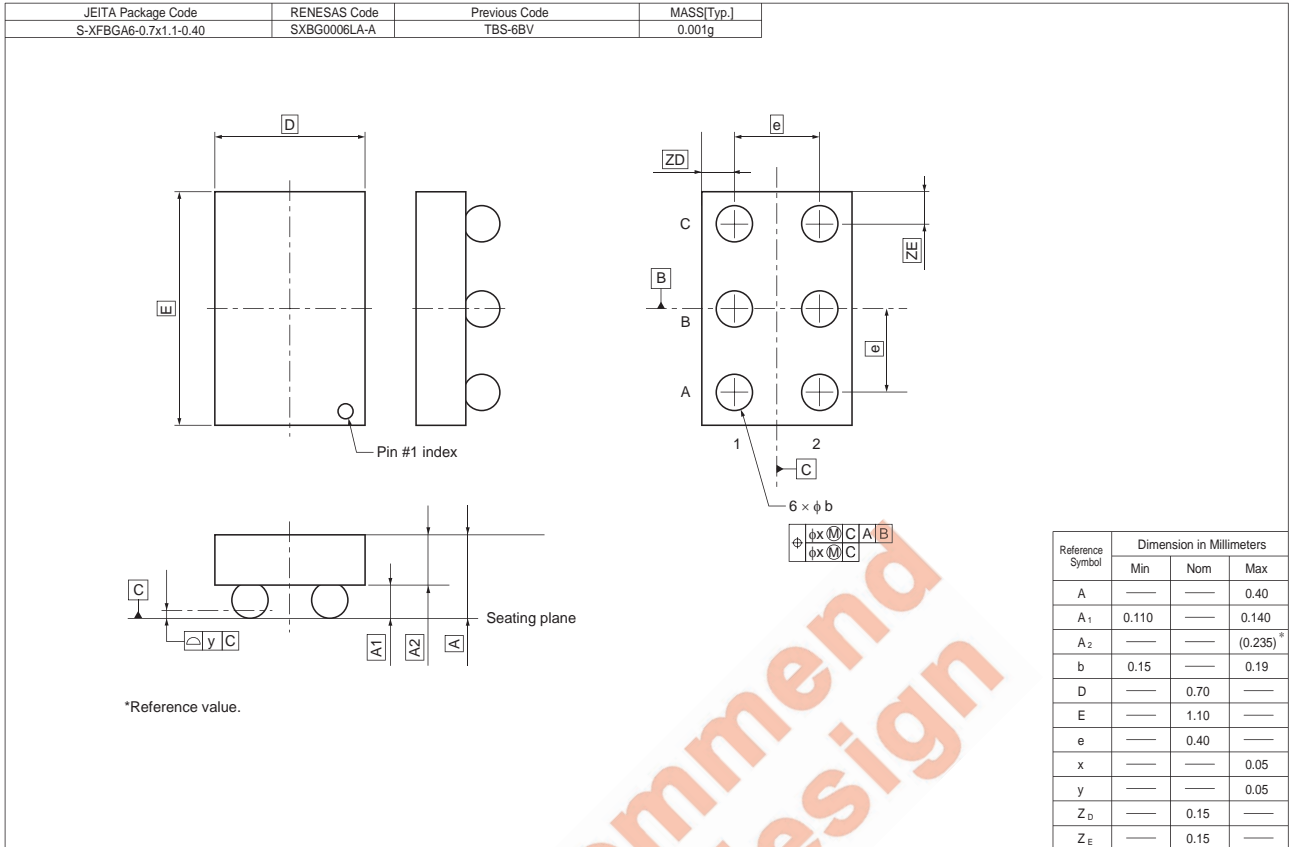

Not recommended for new design

**Keep safety first in your circuit designs!**

1. Renesas Technology Corp. puts the maximum effort into making semiconductor products better and more reliable, but there is always the possibility that trouble may occur with them. Trouble with semiconductors may lead to personal injury, fire or property damage. Remember to give due consideration to safety when making your circuit designs, with appropriate measures such as (i) placement of substitutive, auxiliary circuits, (ii) use of nonflammable material or (iii) prevention against any malfunction or mishap.

**Notes regarding these materials**

1. These materials are intended as a reference to assist our customers in the selection of the Renesas Technology Corp. product best suited to the customer's application; they do not convey any license under any intellectual property rights, or any other rights, belonging to Renesas Technology Corp. or a third party.
  2. Renesas Technology Corp. assumes no responsibility for any damage, or infringement of any third-party's rights, originating in the use of any product data, diagrams, charts, programs, algorithms, or circuit application examples contained in these materials.
  3. All information contained in these materials, including product data, diagrams, charts, programs and algorithms represents information on products at the time of publication of these materials, and are subject to change by Renesas Technology Corp. without notice due to product improvements or other reasons. It is therefore recommended that customers contact Renesas Technology Corp. or an authorized Renesas Technology Corp. product distributor for the latest product information before purchasing a product listed herein.  
The information described here may contain technical inaccuracies or typographical errors.  
Renesas Technology Corp. assumes no responsibility for any damage, liability, or other loss rising from these inaccuracies or errors.  
Please also pay attention to information published by Renesas Technology Corp. by various means, including the Renesas Technology Corp. Semiconductor home page (<http://www.renesas.com>).
  4. When using any or all of the information contained in these materials, including product data, diagrams, charts, programs, and algorithms, please be sure to evaluate all information as a total system before making a final decision on the applicability of the information and products. Renesas Technology Corp. assumes no responsibility for any damage, liability or other loss resulting from the information contained herein.
  5. Renesas Technology Corp. semiconductors are not designed or manufactured for use in a device or system that is used under circumstances in which human life is potentially at stake. Please contact Renesas Technology Corp. or an authorized Renesas Technology Corp. product distributor when considering the use of a product contained herein for any specific purposes, such as apparatus or systems for transportation, vehicular, medical, aerospace, nuclear, or undersea repeater use.
  6. The prior written approval of Renesas Technology Corp. is necessary to reprint or reproduce in whole or in part these materials.
  7. If these products or technologies are subject to the Japanese export control restrictions, they must be exported under a license from the Japanese government and cannot be imported into a country other than the approved destination.  
Any diversion or reexport contrary to the export control laws and regulations of Japan and/or the country of destination is prohibited.
  8. Please contact Renesas Technology Corp. for further details on these materials or the products contained therein.
- 



**RENESAS SALES OFFICES**

<http://www.renesas.com>

Refer to "<http://www.renesas.com/en/network>" for the latest and detailed information.

**Renesas Technology America, Inc.**

450 Holger Way, San Jose, CA 95134-1368, U.S.A  
Tel: <1> (408) 382-7500, Fax: <1> (408) 382-7501

**Renesas Technology Europe Limited**

Dukes Meadow, Millboard Road, Bourne End, Buckinghamshire, SL8 5FH, U.K.  
Tel: <44> (1628) 585-100, Fax: <44> (1628) 585-900

**Renesas Technology (Shanghai) Co., Ltd.**

Unit 204, 205, AZIACenter, No.1233 Lujiazui Ring Rd, Pudong District, Shanghai, China 200120  
Tel: <86> (21) 5877-1818, Fax: <86> (21) 6887-7898

**Renesas Technology Hong Kong Ltd.**

7th Floor, North Tower, World Finance Centre, Harbour City, 1 Canton Road, Tsimshatsui, Kowloon, Hong Kong  
Tel: <852> 2265-6688, Fax: <852> 2730-6071

**Renesas Technology Taiwan Co., Ltd.**

10th Floor, No.99, Fushing North Road, Taipei, Taiwan  
Tel: <886> (2) 2715-2888, Fax: <886> (2) 2713-2999

**Renesas Technology Singapore Pte. Ltd.**

1 Harbour Front Avenue, #06-10, Keppel Bay Tower, Singapore 098632  
Tel: <65> 6213-0200, Fax: <65> 6278-8001

**Renesas Technology Korea Co., Ltd.**

Kukje Center Bldg. 18th Fl., 191, 2-ka, Hangang-ro, Yongsan-ku, Seoul 140-702, Korea  
Tel: <82> (2) 796-3115, Fax: <82> (2) 796-2145

**Renesas Technology Malaysia Sdn. Bhd**

Unit 906, Block B, Menara Amcorp, Amcorp Trade Centre, No.18, Jalan Persiaran Barat, 46050 Petaling Jaya, Selangor Darul Ehsan, Malaysia  
Tel: <603> 7955-9390, Fax: <603> 7955-9510